



EN

# Operating Instructions

## Vacuum Area Gripping System FXCB/FM CB

## Note

These operating instructions were originally written in German and have been translated into English. Store in a safe place for future reference.

Subject to technical changes without notice. No responsibility is taken for printing or other types of errors.

## Published by

© J. Schmalz GmbH, 02.2021

This document is protected by copyright. J. Schmalz GmbH retains the rights established thereby. Reproduction of the contents, in full or in part, is only permitted within the limits of the legal provisions of copyright law. Any modifications to or abridgments of the document are prohibited without explicit written agreement from J. Schmalz GmbH.

## Contact

J. Schmalz GmbH  
Johannes-Schmalz-Str. 1  
72293 Glatten, Germany  
Tel. +49 (0) 7443 2403-0  
Fax +49 (0) 7443 2403-259  
schmalz@schmalz.de  
www.schmalz.com

Contact information for Schmalz companies and trade partners worldwide can be found at  
 [www.schmalz.com/salesnetwork](http://www.schmalz.com/salesnetwork)

1	Safety Instructions.....	5
1.1	Classification of Safety Instructions .....	5
1.2	Prohibition Signs.....	6
1.3	Warnings .....	6
1.4	Mandatory Symbols.....	6
1.5	General Safety Instructions .....	7
1.6	Intended Use .....	8
1.7	Note on the Type Plate.....	9
2	Product Description.....	9
2.1	Functional Principle .....	9
2.2	Design of the FXCB with Integrated Vacuum Generation.....	10
2.3	Design of the FMCB for External Vacuum Generation .....	11
2.4	FXCB design with integrated vacuum generation and bellows suction cups.....	12
3	Technical Data .....	13
4	Transport and Assembly .....	17
4.1	Delivery.....	18
4.1.1	Items Included in Delivery .....	18
4.1.2	Checking for Completeness .....	18
4.1.3	Reporting Damage .....	18
4.2	Packaging.....	18
4.3	Storage .....	18
5	Start of Operations and Setup.....	19
5.1	Mechanical Connection .....	22
5.2	Pneumatic Connection .....	23
5.3	Vacuum Connection (only FMCB).....	24
5.4	Electrical Connection.....	25
6	Operation .....	27
6.1	General Notes .....	27
6.2	Handling Solution .....	30
7	Troubleshooting .....	31
8	Maintenance.....	34
8.1	General Maintenance Instructions.....	34
8.2	Maintenance Schedule.....	35
8.3	External Vacuum Generator (only FMCB) .....	36
8.4	Ejectors (only FXCB).....	36
8.5	Cleaning Agents .....	36
8.6	Sealing Plate .....	36
8.7	Opening the Gripper to Clean the Ejectors (only FXCB) .....	37
8.8	Overview of the Tightening Torque of the Screws .....	38
8.9	Mounting the Vacuum Switch in the Housing.....	39
8.10	Checking the System for Leaks.....	39

9 Spare and Wearing Parts .....40

10 Accessories.....43

11 Pneumatic Circuit Diagram.....44

    11.1 Pneumatic Circuit Diagram FXCB .....44

    11.2 Pneumatic Circuit Diagram FMCB – Parallel Circuit .....45

12 Other Applicable Documents.....45

# 1 Safety Instructions

## 1.1 Classification of Safety Instructions

### Danger

This warning informs the user of a risk that will result in death or serious injury if it is not avoided.

 <b>DANGER</b>	
	<b>Type and source of danger</b> Consequence ► Remedial action

### Warning

This warning informs the user of a risk that could result in death or serious injury if it is not avoided.

 <b>WARNING</b>	
	<b>Type and source of danger</b> Consequence ► Remedial action

### Caution

This warning informs the user of a risk that could result in injury if it is not avoided.

 <b>CAUTION</b>	
	<b>Type and source of danger</b> Consequence ► Remedial action

### Attention

This warning informs the user of a risk that could result in damage to property if it is not avoided.

<b>ATTENTION</b>	
	<b>Type and source of danger</b> Consequence ► Remedial action

### General notes

This symbol is used when important notes and information regarding the use of the machine/the system/the device are provided.

	Note/information
---	------------------









## 1.2 Prohibition Signs

Explanation of the prohibition signs used in the operating instructions.

Icon	Description	Icon	Description
	Do not stand under suspended loads		

## 1.3 Warnings

Explanation of the warning symbols used in the operating instructions.

Icon	Description	Icon	Description
	Pollution warning		Crushing injury
	Suspended load		Hand injury warning
	Electrical voltage		General warning symbol
	Hearing damage		Warning of overpressure
	Electric shock		



## 1.4 Mandatory Symbols



Explanation of the mandatory symbols used in the operating instructions.

Icon	Description	Icon	Description
	Observe the instructions		Wear eye protection
	Use protective footwear		Activate prior to maintenance or repair
	Wear protective gloves		Wear a mask
	Use ear protectors		

## 1.5 General Safety Instructions

The system is state-of-the-art and operationally reliable. However, dangers may arise.

 <b>WARNING</b>	
	<p><b>Failure to comply with the general safety instructions</b></p> <p>Personal injuries and damage to the system</p> <ul style="list-style-type: none"> <li>▶ The operating instructions contain important information on using the system. Read the operating instructions thoroughly and keep them for later reference.</li> <li>▶ The system must only be used by trained personnel who have read and understood the operating instructions.</li> <li>▶ These operating instructions are specific to the items included in delivery from Schmalz. These operating instructions do not take into account any modifications to the system made by the customer.</li> <li>▶ The system may only be connected and operations started once the operating instructions have been read and understood.</li> <li>▶ Use only the connections, mounting holes and attachment materials that have been provided.</li> <li>▶ Carry out mounting or removal only when the device is in a voltage-free and depressurized state.</li> <li>▶ Only qualified specialist personnel, mechanics and electricians may perform the installation. Qualified specialist personnel are persons who have received technical training and have the knowledge and experience – including knowledge of applicable regulations – necessary to enable them to recognize possible dangers and implement the appropriate safety measures while per-</li> <li>▶ General safety regulations, European standards and VDE guidelines must be observed and complied with.</li> <li>▶ The gripper is to be used in combination with an automated handling system (gantry/robot). For this reason, you must also follow the safety regulations of the corresponding system.</li> <li>▶ Animals are not permitted to sit or stand in the transport area.</li> <li>▶ Transporting persons or animals is prohibited!</li> <li>▶ Collaborative operation of the gripper is solely permitted with systems designed for this purpose. The system integrator must ensure that the integrated safety functions are working properly.</li> <li>▶ It is not permitted to make changes to system components.</li> <li>▶ The system may only be operated with the operating voltages specified for the corresponding components.</li> <li>▶ Make sure that the workplace and surroundings are kept clean.</li> <li>▶ Protect the components from damage of any kind.</li> </ul>

 <b>WARNING</b>	
	<p><b>Failure to comply with the general safety instructions</b></p> <p>Personal injuries and damage to the system</p> <ul style="list-style-type: none"> <li>▶ Compressed air or a vacuum could cause closed containers to explode or implode. Check the products before use.</li> <li>▶ Do not apply suction to any dangerous dusts, oil mists, vapors, aerosols, etc.</li> <li>▶ Only use suitable and approved vacuum filters.</li> <li>▶ Do not look into the exhaust air flow of the vacuum generator.</li> </ul>

## 1.6 Intended Use



The gripper is used to lift and transport cardboard boxes or similar materials that allow suction. Neutral gases in accordance with EN 983 are approved as evacuation media. Neutral gases include air, nitrogen and inert gases.

The device may only be used with robot systems that comply with the provisions of DIN IST/TS 15066, DIN EN ISO 10218-1 and DIN EN ISO 10218-2.

Operation as part of a collaborative system is only permitted when the entire system meets the corresponding legal requirements for collaborative robot systems. The system integrator is responsible for ensuring that these requirements are complied with.

The possibilities to do this include:

- The use of redundant vacuum/compressed air generation
- The use of battery-operated audio-visual warning devices to monitor the input pressure and vacuum value
- Safety-oriented vacuum generation and monitoring with a corresponding performance level

 <b>WARNING</b>	
	<p><b>Suspended loads</b></p> <p>Personal injuries and damage to the system</p> <ul style="list-style-type: none"> <li>▶ Never stand under suspended loads.</li> </ul>

The system is mounted on the load suspension provided by the customer using the flanges designated for this purpose. The customer also provides a control device.



## 1.7 Note on the Type Plate

The type plate contains important information about the device. The type plate is firmly attached to the exterior of the device.

The type plate contains the following information:

- Name
- Part number
- Production date
- Serial number

The designation and part number are important for identifying the device. They must always be specified when ordering replacement parts, making warranty claims or making other inquiries about the device.

# 2 Product Description

## 2.1 Functional Principle

The system uses vacuum to lift the defined products. The system can be used to lift one or more cardboard boxes or similar workpieces of various sizes without adapting the suction area to the specific workpiece.

The system achieves its maximum load-bearing capacity when the complete suction area is engaged with an airtight workpiece with a smooth surface.

The robot system, to which the customer's system was attached, is responsible for the motion in the various axes.



When being applied to the workpiece, the foam must be compressed by at least 50%.

## 2.2 Design of the FXCB with Integrated Vacuum Generation

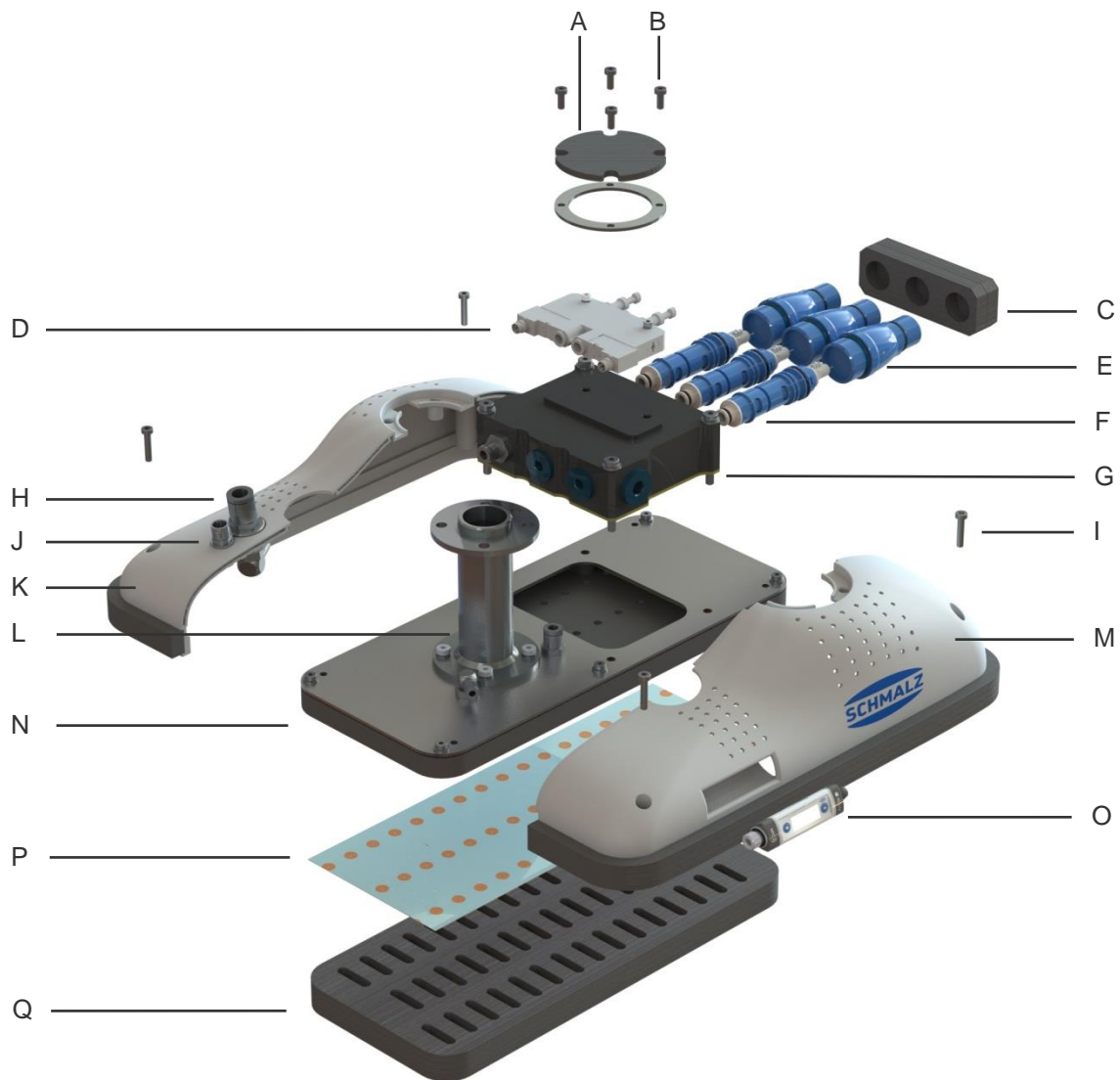

Item	Description
A	Housing cover
B	Machine screw M4x10
C	Silencer
D	Valve
E	Retaining cap SHC
F	Ejector module SEP
G	Ejector block
H	Pneumatic interface Ø 10 mm
I	Machine screw M4x20
J	Electrical interface M12 8-pole
K	Housing right
L	Flange module
M	Housing left
N	Suction trough
O	Vacuum switch VSi
P	Masking film
Q	Sealing plate

## 2.3 Design of the FMCB for External Vacuum Generation

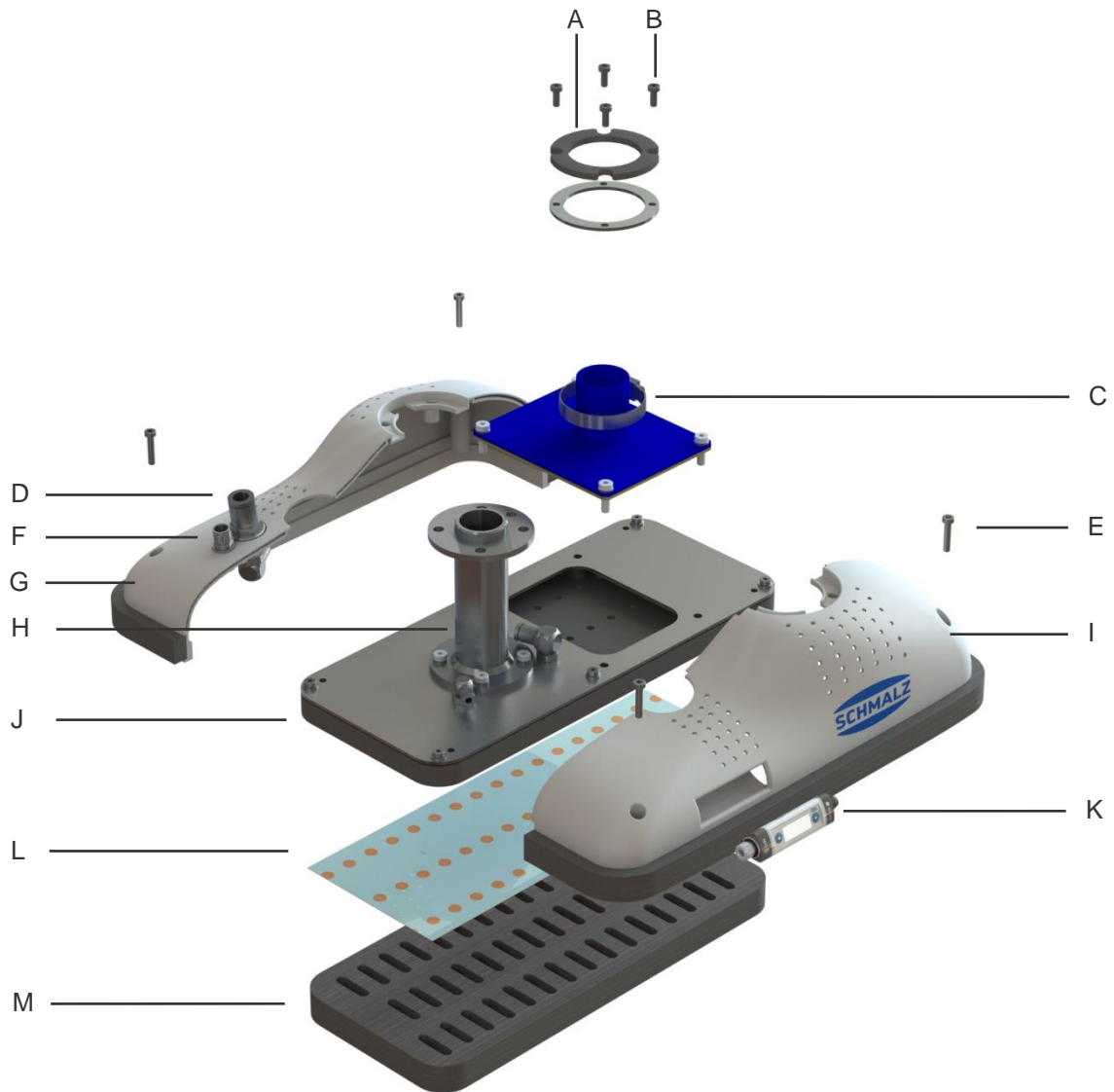

Item	Description
A	Housing cover
B	Machine screw M4x10
C	Hose connector
D	Pneumatic interface Ø 10 mm
E	Machine screw M4x20
F	Electrical interface M12 8-pole
G	Housing right
H	Flange module
I	Housing left
J	Suction trough
K	Vacuum switch VSi
L	Masking film
M	Sealing plate

## 2.4 FXCB design with integrated vacuum generation and bellows suction cups

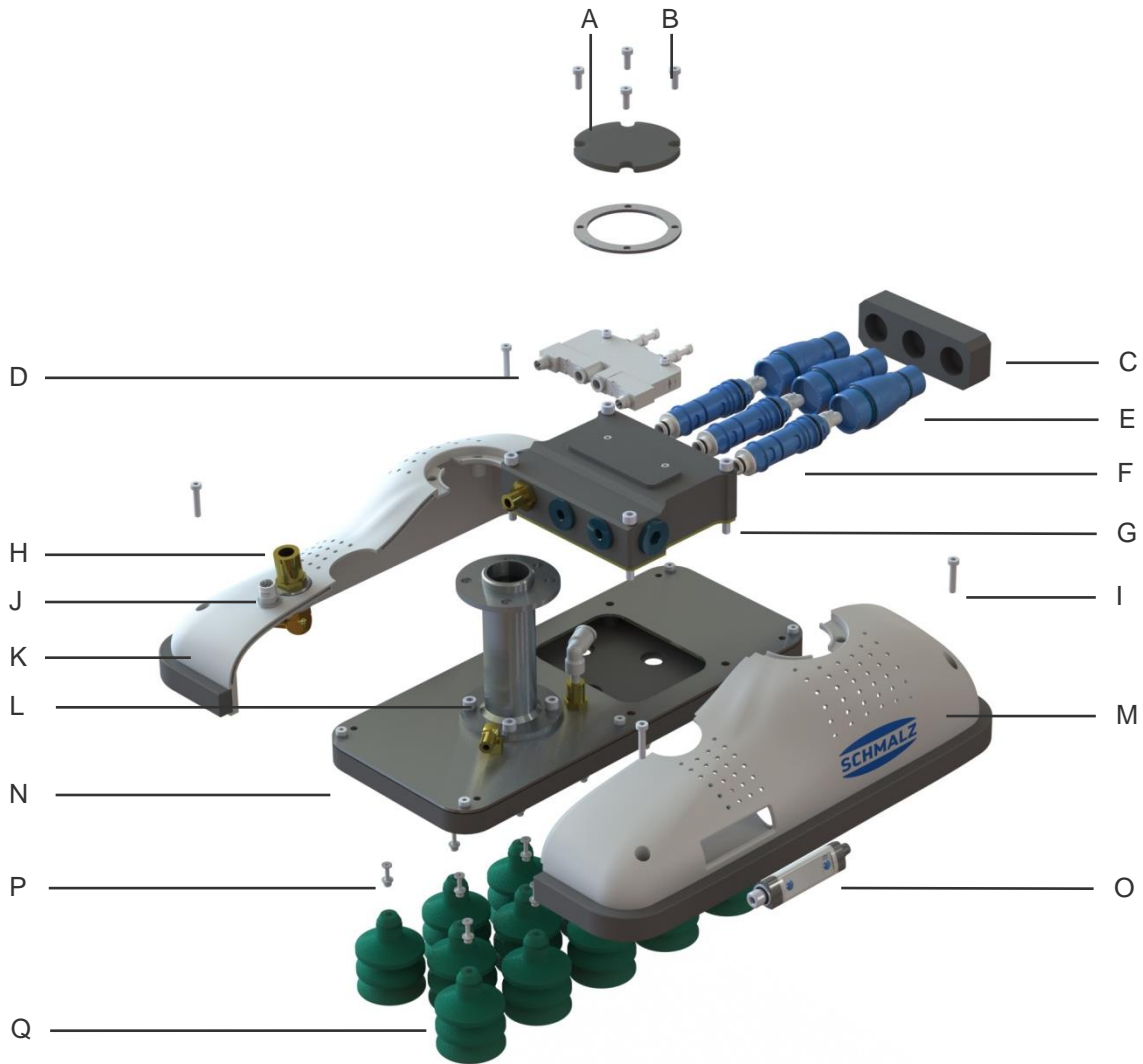

Item	Description
A	housing cover
B	Cheese head screw M4x10
C	silencer
D	valve
E	Retaining cap SHC
F	Ejector module SEP
G	ejector block
H	Pneumatic interface Ø10mm
I	Cheese head screw M4x20
J	Electrical interface M12-8pol
K	Housing right
L	flange module
M	Housing left
N	suction tub
O	Vacuum switch VSi
P	flow resistance
Q	bellows suction cups

### 3 Technical Data

<b>ATTENTION</b>	
	<p><b>Non adherence to the performance limits of the gripper</b></p> <p>Malfunction and damage to the gripper and the attached components.</p> <p>► Only operate the gripper within the specified performance limits</p>

	<b>FXCB</b> With integrated vacuum generation	<b>FMCB</b> For external vacuum generation
<b>Number of suction cells</b>	45 (15 <sup>5</sup> )	45 (15 <sup>5</sup> )
<b>Optimal input pressure</b>	5.5 bar <sup>1</sup>	-
<b>Permitted pressure range</b>	4.5 to 7.0 bar	Max. 7.0 bar <sup>2</sup>
<b>Maximum degree of evacuation</b>	53% <sup>4</sup>	90% <sup>4</sup>
<b>Compressed air consumption</b>	217 l/min <sup>4</sup>	-
<b>Suction flow</b>	354 l/min	-
<b>Required suction flow rate</b>	-	372.3 l/min <sup>3,4</sup>
<b>Permissible load</b>	80 N	80 N
<b>Maximum load with purely horizontal movement<sup>6</sup></b>	350N	350N
<b>Weight</b>	2,0 kg (2,2kg <sup>5</sup> )	1.6 kg (1,8kg <sup>5</sup> )
<b>Operating voltage</b>	24V DC	24V DC
<b>Permitted temperature range</b>	+5 to +40° C	+5 to +40° C
<b>Sound level at full coverage</b>	67.5 dB(A) <sup>4</sup>	-
<b>Protection class</b>	IP40	IP40

<sup>1</sup> At this pressure, the integrated ejectors have optimal energy efficiency.

<sup>2</sup> For this gripper version, the compressed air is only used to more quickly deposit loads.

<sup>3</sup> At a vacuum of -0.15 bar, the vacuum generator must provide the specified suction flow rate (at the vacuum connection pieces of the FMCB).

<sup>4</sup> Attention: this refers to real measured values without additional safety

<sup>5</sup> When using suction cups instead of sealing foam

<sup>6</sup> Only for load case 2 and maximum 2m/s<sup>2</sup> acceleration

#### **NFC tags in the gripper**



Two NFC tags are integrated into the gripper. The first is located under the type plate and links to the gripper page in the Schmalz app. The second is located in the vacuum switch and links to the vacuum switch page.

To use the tags, hold an NFC-enabled device over the place where the NFC logo is attached.

The linked pages contain data, part numbers and the operating instructions for the respective parts.

#### **Vacuum in the gripper**



For workpieces typical for the application (e.g. cardboard boxes), a vacuum between 250 and 300 mbar is recommended.

A vacuum lower than 200 mbar is not recommended.

The overpressure in the gripper must be limited to a maximum of 0.2 bar.



Consult the manufacturer before operating it at higher or lower ambient temperatures.

Dimensions:

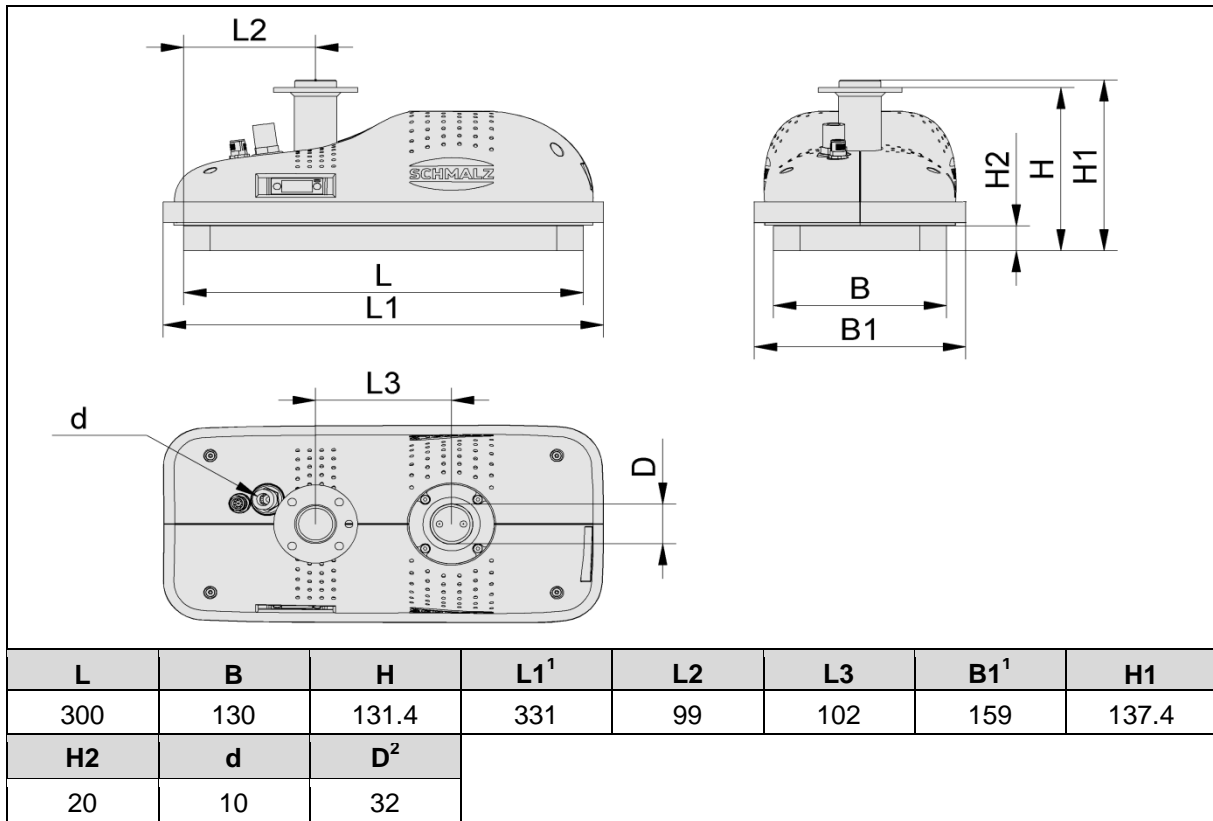

<sup>1</sup> Exact dimensions vary based on the circumferential foam

<sup>2</sup> Only for the FMCB

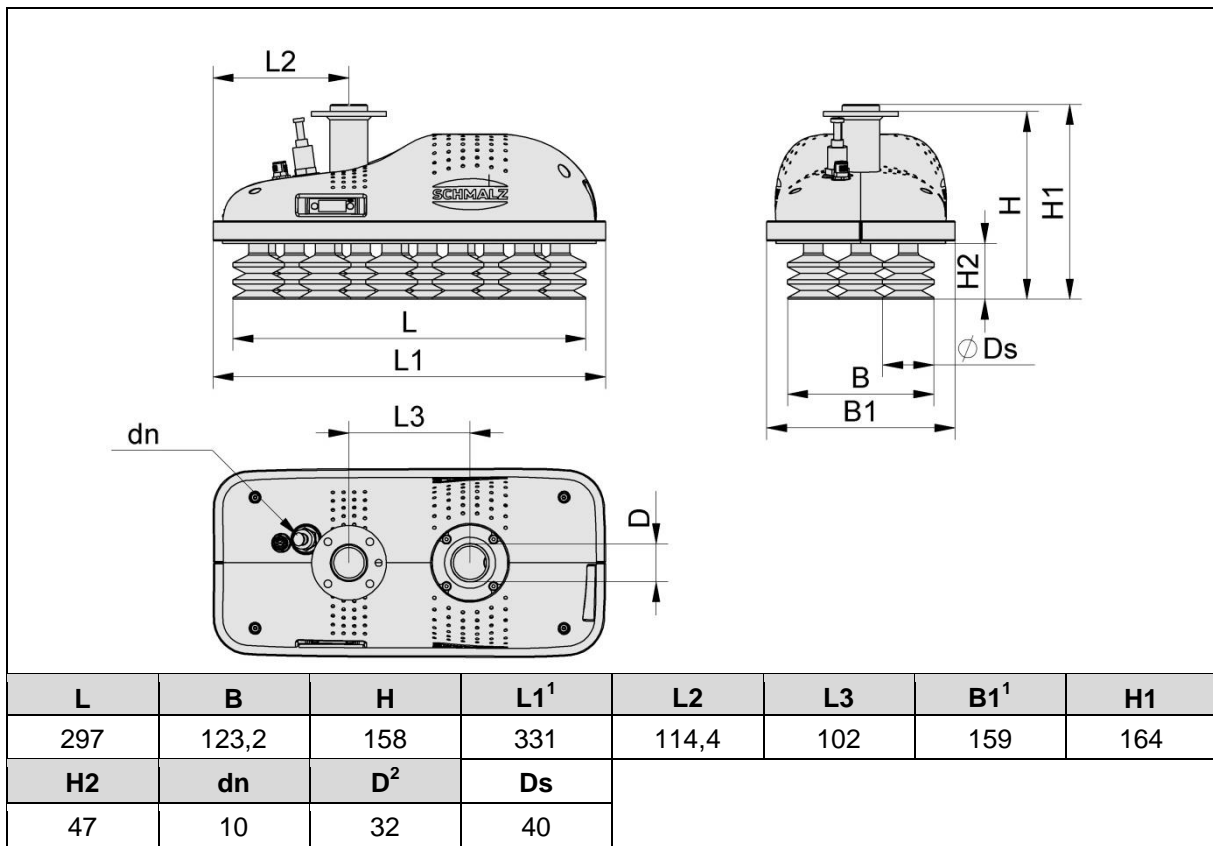

<sup>1</sup> Exact dimensions vary due to the surrounding foam

<sup>2</sup> FMCB only

Centre of mass and moments of inertia::

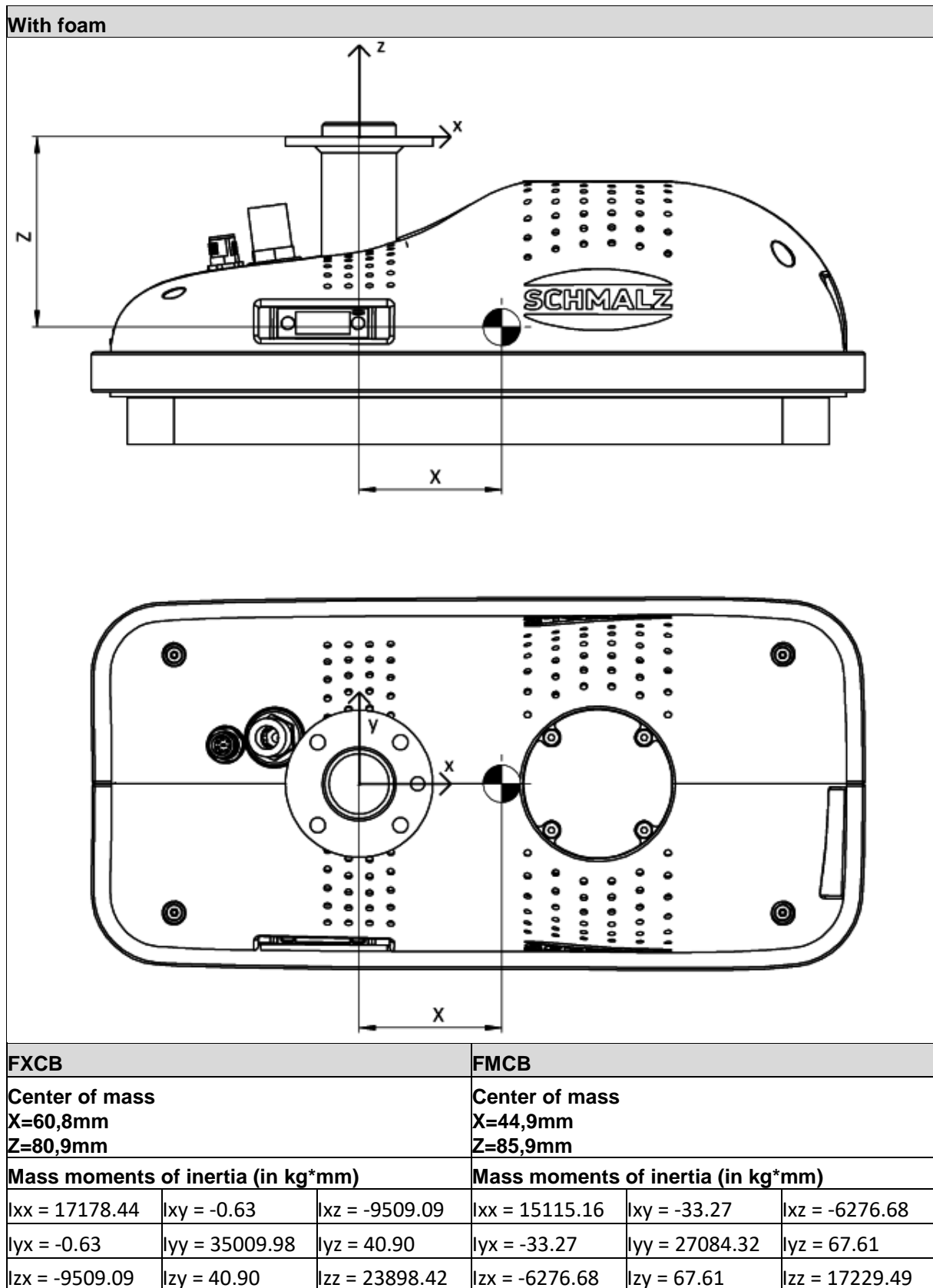

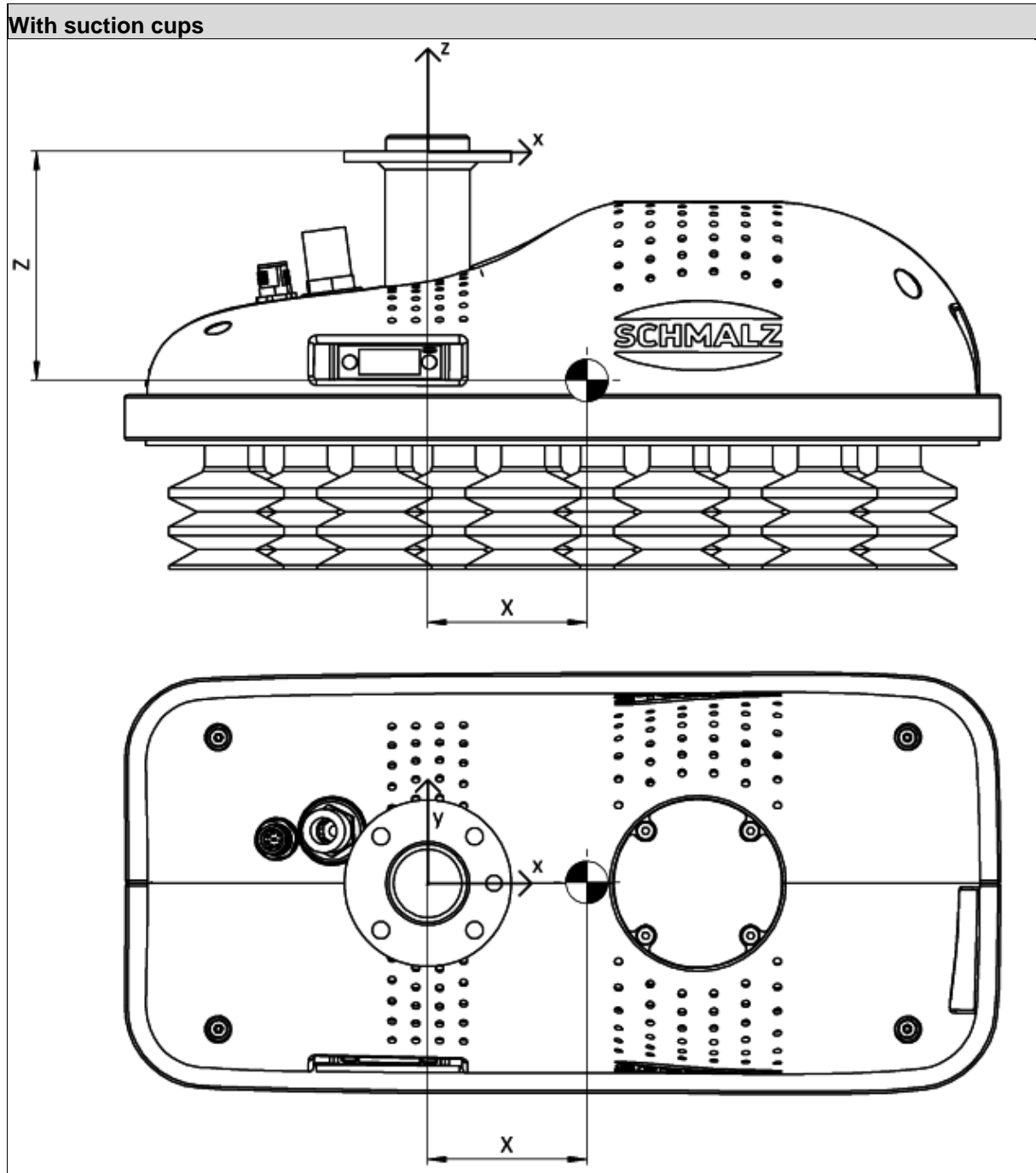







FXCB			FMCB		
<b>Center of mass</b> X=59,3mm Z=86,5mm			<b>Center of mass</b> X=46,0mm Z=92,4mm		
<b>Mass moments of inertia (in kg*mm)</b>			<b>Mass moments of inertia (in kg*mm)</b>		
$I_{xx} = 21695.77$	$I_{xy} = 14.97$	$I_{xz} = -10983.51$	$I_{xx} = 19578.87$	$I_{xy} = -12.31$	$I_{xz} = -7812.20$
$I_{yx} = 14.97$	$I_{yy} = 41275.75$	$I_{yz} = 37.39$	$I_{yx} = -12.31$	$I_{yy} = 33254.99$	$I_{yz} = 115.72$
$I_{zx} = -10983.51$	$I_{zy} = 37.39$	$I_{zz} = 26216.61$	$I_{zx} = -7812.20$	$I_{zy} = 115.72$	$I_{zz} = 19493.77$



<b>ATTENTION</b>	
	<p><b>Using vacuum hoses that are too rigid with cobots (FMCB only)</b></p> <p>Stopping the robot by interpreting the resistance of the hose as a collision with the person</p> <ul style="list-style-type: none"> <li>▶ Before operation, check whether the resistance force of the vacuum hose causes the robot to stop</li> </ul>

## 4 Transport and Assembly

<b>ATTENTION</b>	
	<p><b>Incorrect disposal of the system or individual components</b></p> <p>Environmental damage</p> <ul style="list-style-type: none"> <li>▶ Disposal according to national guidelines.</li> </ul>

<b>WARNING</b>	
    	<p><b>Improper securing of the load</b></p> <p>Improper unloading and transport can result in personal injuries and damage to property. Moving loads can tip over, fall or crush people. When lifting transport units, parts can fall over, move or fall out. Danger to life and limb.</p> <ul style="list-style-type: none"> <li>▶ Only transport loads that are sufficiently secured against slipping.</li> <li>▶ Ensure that all persons leave the hoist danger zone before the transport units are lifted.</li> <li>▶ Wear protective footwear and additional safety equipment if necessary.</li> <li>▶ Only trained personnel who have received safety instructions may unload and transport the product.</li> </ul>

## 4.1 Delivery

### 4.1.1 Items Included in Delivery

For the exact items included in delivery, please refer to the order confirmation.  
In addition to the gripper, the following is included in delivery:

- 4 pcs. M6x12 machine screw according to DIN 7984 for mounting the gripper on the robot
- 4 pcs. Safety washers to secure against accidental release of the gripper during operation
- 1 pc Dowel pin Ø 6 mm for exact position locking
- 1 pc Allen key, size 4, for tightening the screws
- 1 pc Quick Reference Guide
- 1 pc Electrical connection cable for connecting the gripping system to the robot (optional)
- 1 pc Hose clamp (only for FMCB)

#### Note

The operating instructions are part of the system and must be kept with the system every time it is relocated.

### 4.1.2 Checking for Completeness

Using the enclosed delivery documents, check the entire shipment to ensure that it is complete. Also refer to our Terms and Conditions of Sale and Delivery.

### 4.1.3 Reporting Damage

After delivery of the shipment, damage due to faulty packaging or transport must be reported immediately to the carrier and J.Schmalz GmbH.

## 4.2 Packaging







The system is shipped in a transport box made specifically for the system.





## 4.3 Storage



The system must be stored in its original packaging as long as it is not being used and is to be stored for any period of time.





<b>ATTENTION</b>	
	<p><b>Incorrect storage of the system</b></p> <p>Material damage to the system</p> <p>▶ The system may only be stored as described in the operating instructions.</p>

## 5 Start of Operations and Setup

 <b>CAUTION</b>	
	<p><b>General notes on the start of operations</b></p> <p>Risk of injuries</p> <ul style="list-style-type: none"> <li>▶ The system integrator must secure the danger zone.</li> <li>▶ The production system must be stopped in the area where the system is being set up.</li> <li>▶ The system may only be set up at the workplace in accordance with the operating instructions.</li> <li>▶ The system must be disconnected and depressurized during setup.</li> <li>▶ The production system must be secured to prevent activation during setup.</li> </ul>
 	<p><b>Approach of a moving element to a fixed part/machinery mobility/moving elements</b></p> <p>Body parts could be crushed, sucked in or caught if the flat suction cup is abruptly attached to a workpiece or a surface.</p> <ul style="list-style-type: none"> <li>▶ Do not place any body parts between the bottom of the gripper and a surface.</li> </ul>
	<p><b>High pressure</b></p> <p>Placement/release of compressed air lines</p> <ul style="list-style-type: none"> <li>▶ The system integrator must secure the danger zone.</li> <li>▶ Regularly inspect the gripper and perform regular maintenance in order to detect and replace porous compressed air lines in good time. Replace defective connectors.</li> </ul>
	<p><b>Stored energy/vacuum</b></p> <p>Body parts could be crushed, cut, sucked in, caught or sliced if the flat suction cup is abruptly attached to a workpiece or a surface.</p> <ul style="list-style-type: none"> <li>▶ Do not place any body parts between the bottom of the gripper and a surface.</li> <li>▶ Eyes can be sucked in; do not look into open vacuum openings.</li> </ul>
	<p><b>Conductive parts/parts that have become live in an error state/short circuits</b></p> <p>Electric shock</p> <ul style="list-style-type: none"> <li>▶ Regularly inspect and perform maintenance on the gripper to detect and repair wear or faulty connections in good time.</li> </ul>

 <b>CAUTION</b>	
 	<p><b>Noise hazards due to the exhaust system or gas flowing at high speeds or worn parts</b></p> <p>Discomfort, tinnitus, stress, exhaustion due to constant/ high noise levels</p> <ul style="list-style-type: none"> <li>▶ If possible, switch off vacuum generators (only FMCB) and the blow-off function when not in use in order to reduce noise pollution.</li> <li>▶ Wear personal protective equipment e.g. ear protectors</li> <li>▶ If possible, position vacuum generators (only FMCB) far enough away from machine operators; use additional silencers</li> <li>▶ Regularly inspect and perform maintenance on the system in order to ensure that it works properly.</li> </ul>
	<p><b>Careless use of personal protective equipment</b></p> <p>Danger to the operator</p> <ul style="list-style-type: none"> <li>▶ Adapt and wear appropriate personal protective equipment based on the task being performed.</li> </ul>

 <b>WARNING</b>	
	<p><b>System setup by untrained personnel</b></p> <p>Serious personal injury</p> <ul style="list-style-type: none"> <li>▶ The system must only be set up by trained personnel who have read and understood the operating instructions.</li> </ul>
	<p><b>Non-compliance with work safety instructions</b></p> <p>Personal injuries and damage to the system</p> <ul style="list-style-type: none"> <li>▶ Never lift loads at an angle and never drag them.</li> <li>▶ Do not tear off stuck loads.</li> <li>▶ Only pick up and lift suitable loads (check inherent stability and surface density).</li> <li>▶ Only set workpieces down on clear, even surfaces due to the danger of slipping.</li> <li>▶ Do not release the load until it rests completely and safely on a secure surface.</li> <li>▶ Do not come close to the load when releasing/depositing it and do not touch it.</li> </ul>

 <b>DANGER</b>	
 	<p><b>General safety notes on the start of operations</b></p> <p>Danger to life and limb</p> <ul style="list-style-type: none"> <li>▶ The system must only be set up by trained personnel who have read and understood the operating instructions.</li> <li>▶ The system integrator must secure the danger zone.</li> <li>▶ The production system must be stopped in the area where the system is being set up</li> <li>▶ The system may only be set up at the workplace in accordance with the operating instructions.</li> <li>▶ The system must be disconnected during setup.</li> <li>▶ The production system must be secured to prevent activation during setup.</li> </ul>
	<p><b>Acceleration/deceleration/kinetic energy</b></p> <p>Danger to life and limb</p> <ul style="list-style-type: none"> <li>▶ See general safety notes on the start of operations</li> </ul>
 	<p><b>Danger of falling objects/gravity:</b></p> <p>Danger to life and limb</p> <ul style="list-style-type: none"> <li>▶ See general safety notes on the start of operations</li> <li>▶ Never stand under suspended loads.</li> </ul>
	<p><b>Human error</b></p> <p>Danger to life and limb</p> <ul style="list-style-type: none"> <li>▶ Adhere to the operating instructions</li> </ul>

## 5.1 Mechanical Connection

The system is equipped with a flange connection in accordance with ISO 9409-1-50-4-M6:

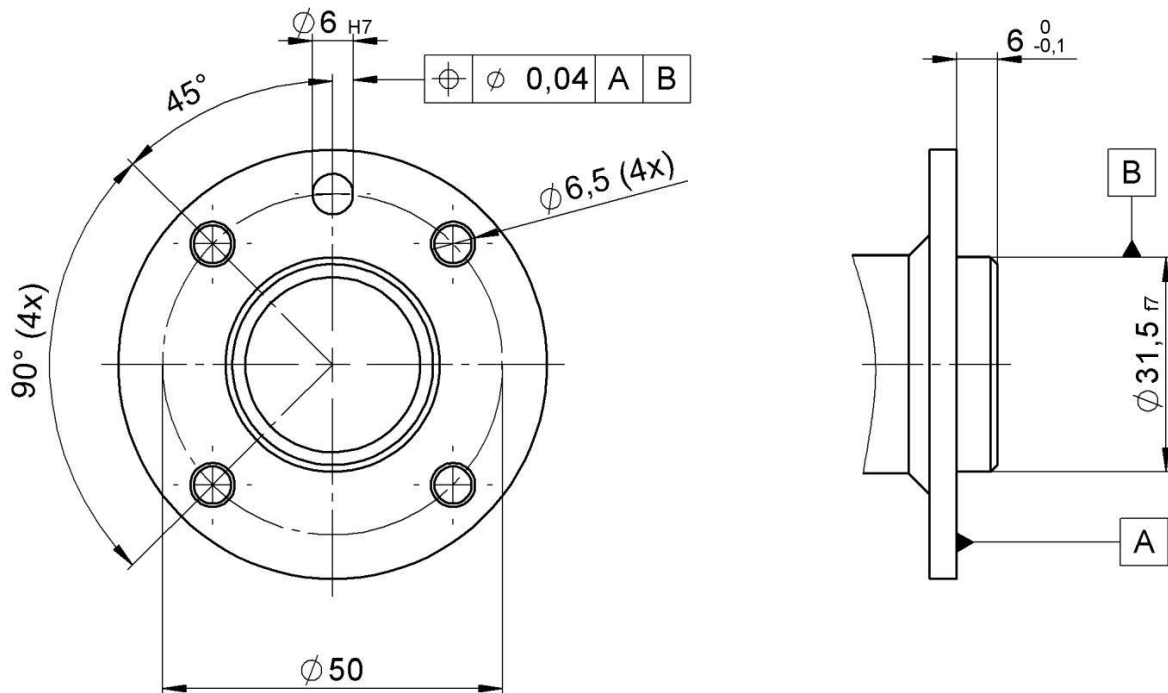

The gripper initially comes equipped with a  $\text{Ø}31.5 \text{ f7}$  base in the corresponding robot flange adapter in order to mount the gripper onto the robot/system.

Afterwards, the position of the gripper can be precisely determined using the included dowel pin if desired. To do so, position the  $\text{Ø}6\text{H7}$  bore hole of the gripper flange so that it is congruent with the  $\text{Ø}6\text{H7}$  bore hole of the robot flange. Then fix the position by inserting the dowel pin.

Use the included screws and safety washers to mount the gripper on the robot. The required tightening torque can be found in the operating instructions of the robot system.

The system must be attached securely, taking the weight of the system and its maximum load-bearing capacity into account.



### Alternative flange images

Attention: The flange shown here is the standard flange according to ISO 9409-1-50-4-M6. When ordering a gripper for a special robot type, the flange installed may differ from the one shown here.

## 5.2 Pneumatic Connection

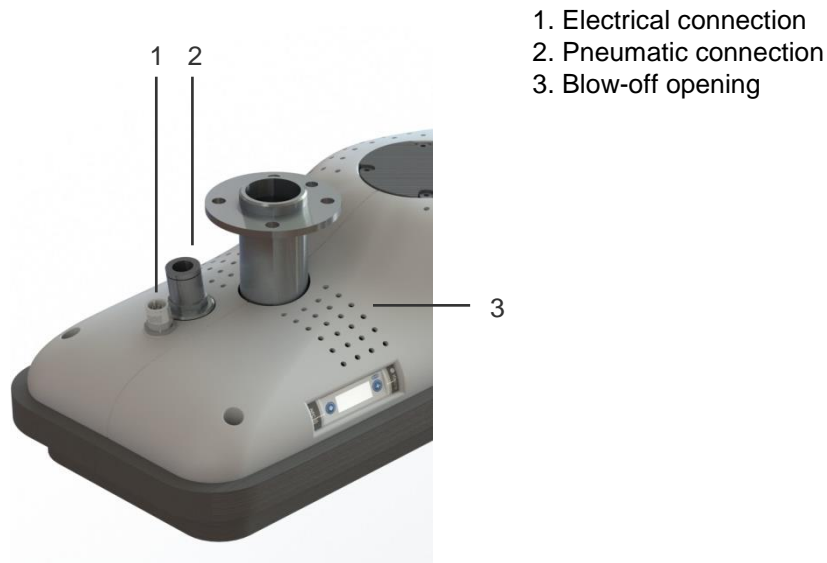

1. Electrical connection
2. Pneumatic connection
3. Blow-off opening

The compressed air is connected using the plug-in screw union for compressed air hoses, which is located on the sealing plate and is included in delivery. Requirements for the compressed air provided by the customer:

- Dry, filtered air according to ISO 8573-1:2010 [7:4:4]
- Constant operating pressure: 5.5 bar.

If you select a supply hose that is too small, the compressed air supplied to the pneumatic elements will not be enough for optimal operation.



### Maximum overpressure

The maximum overpressure in the gripper must be limited to a maximum of 0.2 bar.



### Ventilation

The openings along the housing of the gripper serve as outlets for the exhaust air from the ejectors (only FXCB). In order to maintain the gripper's functionality, these openings may not be closed or covered.



### Alternative hose connections

Plug-in screw unions for alternative hose sizes as well as corresponding compressed air hoses are available on request.

### 5.3 Vacuum Connection (only FMCB)

1. Hose connection
2. Hose clamp

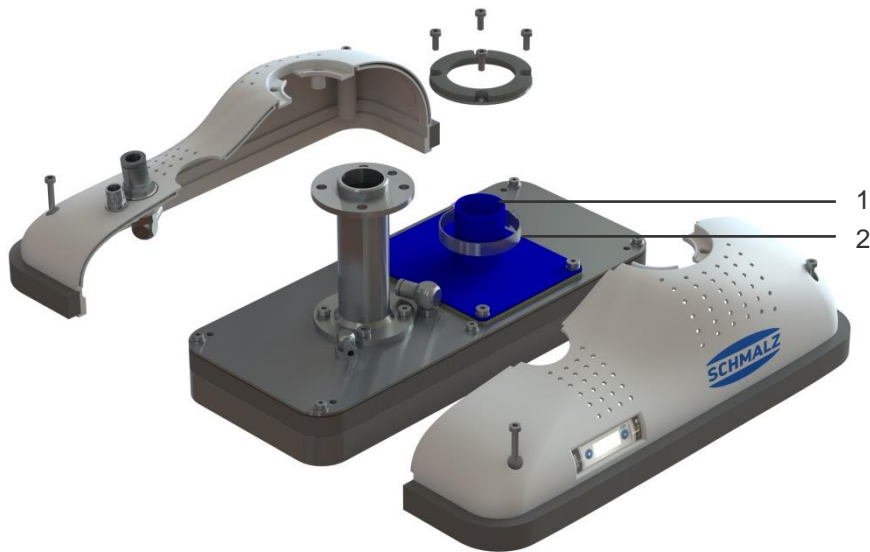

A hose that is suitable for vacuum applications must be connected at the installed hose connection and secured with the included hose clamps. The supply hose must have the same nominal diameter as the installed connection. The maximum recommended hose length is around 10 meters. For instructions on opening the housing, see chapter 8.7.



#### **Vacuum**

Once vacuum is applied in a gripper, it immediately begins suction.





## 5.4 Electrical Connection

The connection for control of the solenoid valve (only FXCB) and the vacuum switch is made using an 8-pole M12 connector that is integrated into the housing.

The installed valve and the valve switch are switched via PNP.

The plug connectors must not be connected or disconnected when the system is live.

The power supply and signal inputs have a maximum line length of 30 meters.

 <b>DANGER</b>	
 	<p><b>Inappropriate voltage supply</b> Electric shock, destruction of the electrical components</p> <ul style="list-style-type: none"> <li>▶ Connection work may only be carried out by a qualified electrical specialist.</li> <li>▶ The system must incorporate safe electrical cut-off of the power supply in compliance with EN60204</li> <li>▶ Do not connect or disconnect the plug connectors when voltage is applied.</li> <li>▶ Only operate the system with protected extra-low voltage.</li> </ul>

	<p>Observe the corresponding operating instructions when connecting the external vacuum generator (only FMCB).</p>
---	--

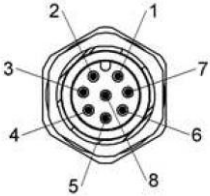
Plug	Pin	Lead color	Function (PNP)	Function with IO-Link
	1	White	Not used	
	2	Brown	24V DC power supply	
	3 <sup>1</sup>	Green	Valve ground	
	4 <sup>1</sup>	Yellow	“Suction OFF” signal input <sup>2,3</sup>	
	5	Gray	Signal output 2	IO-Link communication
	6 <sup>1</sup>	Pink	“Vent ON” signal input	
	7	Blue	Vacuum switch ground	
	8	Red	Signal output 1	

<sup>1</sup> These pins are only assigned for the FXCB version. These pins are not assigned for gripper FMCB.

<sup>2</sup> The installed valve for suction is normally open. In the de-energized or disconnected state, the gripper is in “Suction” mode.

<sup>3</sup> Optionally, the gripper is also available with a “normally closed”, in which case the function of pin 4 changes to “Suction ON”.

<b>ATTENTION</b>	
	<p><b>Incorrectly connected screw union</b> Malfunction</p> <ul style="list-style-type: none"> <li>▶ The multi-pole plug’s screw union must be sealed securely and correctly during installation of the customer’s cable.</li> </ul>



The grippers FXCB 10.01.43.00001 and FMCB 10.01.43.00002 are PNP-switched. NPN-switched versions of these grippers are available upon request (FXCB 10.01.43.00016 and FMCB 10.01.43.00017).

The NPN pin assignments are as follows:

Plug	Pin	Lead color	Function (NPN)	Function with IO-Link
	1	White	24V DC Power supply of the valve	
	2	Brown	24V DC power supply	
	3	Green	Not used	
	4 <sup>1</sup>	Yellow	"Suction OFF" signal input <sup>2,3</sup>	
	5	Gray	Signal output 2	IO-Link communication
	6 <sup>1</sup>	Pink	"Vent ON" signal input	
	7	Blue	Vacuum switch ground	
	8	Red	Signal output 1	





<sup>1</sup> These pins are only assigned for the FXCB version. These pins are not assigned for gripper FMCB.





<sup>2</sup> The installed valve for suction is normally open. In the de-energized or disconnected state, the gripper is in "Suction" mode.



<sup>3</sup> Optionally, the gripper is also available with a "normally closed" valve, in which case the function of pin 4 changes to "suction ON".





## 6 Operation

### 6.1 General Notes

 <b>CAUTION</b>	
	<p><b>General Notes on Operation</b></p> <p>Risk of injuries</p> <p>The system integrator must ensure that the entire system complies with the provisions of DIN IST/TS 15066, DIN EN ISO 10218-1 and DIN EN ISO 10218-2.</p> <ul style="list-style-type: none"> <li>▶ The system may only be operated at the workplace in accordance with the operating instructions.</li> </ul>
	<p><b>Approach of a moving element to a fixed part/machinery mobility/moving elements</b></p> <p>Body parts could be crushed, sucked in or caught if the flat suction cup is abruptly attached to a workpiece or a surface or by moving parts.</p> <ul style="list-style-type: none"> <li>▶ Do not place any body parts between the bottom of the gripper and a surface.</li> </ul>
	<p><b>High pressure</b></p> <p>Placement/release of compressed air lines</p> <ul style="list-style-type: none"> <li>▶ The system integrator must secure the danger zone.</li> <li>▶ Regularly inspect the gripper and perform regular maintenance in order to detect and replace porous compressed air lines in good time. Replace defective connectors.</li> </ul>
	<p><b>Stored energy/vacuum</b></p> <p>Body parts could be crushed, cut, sucked in, caught or sliced if the flat suction cup is abruptly attached to a workpiece or a surface.</p> <ul style="list-style-type: none"> <li>▶ Do not place any body parts between the bottom of the gripper and a surface.</li> <li>▶ Eyes can be sucked in; do not look into open vacuum openings.</li> </ul>
	<p><b>Conductive parts/parts that have become live in an error state/short circuits</b></p> <p>Electric shock</p> <ul style="list-style-type: none"> <li>▶ Regularly inspect and perform maintenance on the gripper to detect and repair wear or faulty connections in good time.</li> </ul>

 <b>CAUTION</b>	
 	<p><b>Noise hazards due to the exhaust system or gas flowing at high speeds or worn parts</b></p> <p>Discomfort, tinnitus, stress, exhaustion due to constant/ high noise levels</p> <ul style="list-style-type: none"> <li>▶ If possible, switch off vacuum generators (only FMCB) and the blow-off function when not in use in order to reduce noise pollution.</li> <li>▶ Wear personal protective equipment e.g. ear protectors</li> <li>▶ If possible, position vacuum generators (only FMCB) far enough away from machine operators; use additional silencers</li> <li>▶ Regularly inspect and perform maintenance on the system in order to ensure that it works properly.</li> </ul>
	<p><b>Careless use of personal protective equipment</b></p> <p>Danger to the operator</p> <ul style="list-style-type: none"> <li>▶ Adapt and wear appropriate personal protective equipment based on the task being performed.</li> </ul>

 <b>WARNING</b>	
	<p><b>System operation by untrained personnel</b></p> <p>Serious personal injury</p> <ul style="list-style-type: none"> <li>▶ The system may only be operated by trained personnel who have read and understood the operating instructions.</li> </ul>
	<p><b>Non-compliance with work safety instructions</b></p> <p>Personal injuries and damage to the system</p> <ul style="list-style-type: none"> <li>▶ Never lift loads at an angle and never drag them.</li> <li>▶ Do not tear off stuck loads.</li> <li>▶ Only pick up and lift suitable loads (check inherent stability and surface density).</li> <li>▶ Only set workpieces down on clear, even surfaces due to the danger of slipping.</li> <li>▶ Do not release the load until it rests completely and safely on a secure surface.</li> <li>▶ Do not come close to the load when releasing/depositing it and do not touch it.</li> </ul>

 <b>DANGER</b>	
 	<p><b>General Safety Notes on Operation</b></p> <p>Danger to life and limb</p> <ul style="list-style-type: none"> <li>▶ The system may only be operated by trained personnel who have read and understood the operating instructions.</li> </ul> <p>Operation in a collaborative system is only permitted when the entire system complies with the corresponding requirements for collaborative robot systems in accordance with DIN IST/TS 15066, DIN EN ISO 10218-1 and DIN EN ISO 10218-2.</p> <ul style="list-style-type: none"> <li>▶ The system may only be operated at the workplace in accordance with the operating instructions.</li> </ul>
	<p><b>Acceleration/deceleration/kinetic energy</b></p> <p>Danger to life and limb due to workpieces slinging away</p> <ul style="list-style-type: none"> <li>▶ See general safety notes on the start of operations</li> <li>▶ Maintain sufficient distance to the moving system/workpiece in order to avoid danger, even in the case of unforeseeable events (e.g. emergency stop)</li> </ul>
 	<p><b>Danger of falling objects/gravity due to falling objects</b></p> <p>Danger to life and limb</p> <ul style="list-style-type: none"> <li>▶ See general safety notes on the start of operations</li> <li>▶ Never stand under suspended loads.</li> <li>▶ Do not place any body parts under the suspended load or the system.</li> <li>▶ The system's maximum permitted load must not be exceeded.</li> </ul>
	<p><b>Human error</b></p> <p>Danger to life and limb</p> <ul style="list-style-type: none"> <li>▶ Adhere to the operating instructions</li> </ul>
	<p><b>Switching components that are not explosion-proof</b></p> <p>Risk of fire and explosion</p> <ul style="list-style-type: none"> <li>▶ The product must not be used in explosion risk areas.</li> </ul>



Consult the manufacturer before operating it at ambient temperatures higher or lower than the permitted temperatures.



For the maximum permitted load, see the technical data.

## 6.2 Handling Solution











### Optimized control



Only turn on the suction when workpieces are being lifted. Otherwise, additional dust from the environment is drawn in, which could shorten the necessary maintenance intervals.

Simplified diagram of a gripper	
<h3>Applying suction</h3> <ul style="list-style-type: none"> <li>The gripper is placed onto the workpiece being handled.</li> <li>The sealing plate must be compressed by at least 50% to ensure that the workpiece is securely gripped.</li> <li><b>Only FXCB:</b> The gripper is reset to the "Suction" state by switching the "Suction OFF" pin (see chapter 5.4). In order for this to occur, there must be compressed air at the compressed air connection.</li> <li><b>Only FMCB:</b> Vacuum is generated externally and must be present at the vacuum connection. An additional valve for switching between "Suction ON" and "Suction OFF" is required.</li> <li>Once the pre-set vacuum value is reached (green light on the vacuum switch is on and there is an output signal on the "Signal output 2" pin – see attached operating instructions), the gripper may be moved.</li> </ul>	
<h3>Setting down</h3> <ul style="list-style-type: none"> <li>Once the workpiece has been transported and safely set down on the target surface, it must be deposited.</li> <li><b>Only FXCB:</b> Switching on the "Suction OFF" pin ends suction operation. Optionally, compressed air can be blown into the suction chamber in order to more quickly deposit the workpiece by switching on the "Vent ON" pin. In order for this to occur, there must be compressed air at the compressed air connection.</li> <li><b>Only FMCB:</b> To deposit the workpiece, the vacuum must be switched off or disconnected at the vacuum connection. Optionally, compressed air can be blown into the suction chamber via the compressed air connection in order to more quickly deposit the workpiece.</li> <li>Once the workpiece has been deposited, the gripper must be returned to a neutral state (Suction OFF and Blow-off OFF).</li> </ul>	

# 7 Troubleshooting

 <b>CAUTION</b>	
	<p><b>General notes on troubleshooting</b></p> <p>Risk of injuries</p> <ul style="list-style-type: none"> <li>▶ The system integrator must secure the danger zone.</li> <li>▶ The system may only be operated at the workplace in accordance with the operating instructions.</li> </ul>
	<p><b>Approach of a moving element to a fixed part/machinery mobility/moving elements</b></p> <p>Body parts could be crushed, sucked in or caught if the flat suction cup is abruptly attached to a workpiece or a surface or by moving parts</p> <ul style="list-style-type: none"> <li>▶ Do not place any body parts between the bottom of the gripper and a surface.</li> </ul>
	<p><b>High pressure</b></p> <p>Placement/release of compressed air lines</p> <ul style="list-style-type: none"> <li>▶ The system integrator must secure the danger zone.</li> <li>▶ Regularly inspect the gripper and perform regular maintenance in order to detect and replace porous compressed air lines in good time. Replace defective connectors.</li> </ul>
	<p><b>Stored energy/vacuum</b></p> <p>Body parts could be crushed, cut, sucked in, caught or sliced if the flat suction cup is abruptly attached to a workpiece or a surface.</p> <ul style="list-style-type: none"> <li>▶ Do not place any body parts between the bottom of the gripper and a surface.</li> <li>▶ Eyes can be sucked in; do not look into open vacuum openings.</li> </ul>
	<p><b>Conductive parts/parts that have become live in an error state/short circuits</b></p> <p>Electric shock</p> <ul style="list-style-type: none"> <li>▶ Regularly inspect and perform maintenance on the gripper to detect and repair wear or faulty connections in good time.</li> </ul>

 <b>CAUTION</b>	
 	<p><b>Noise hazards due to the exhaust system or gas flowing at high speeds or worn parts</b></p> <p>Discomfort, tinnitus, stress, exhaustion due to constant/ high noise levels</p> <ul style="list-style-type: none"> <li>▶ If possible, switch off vacuum generators and the blow-off function when not in use in order to reduce noise pollution.</li> <li>▶ Wear personal protective equipment e.g. ear protectors</li> <li>▶ If possible, position vacuum generators far enough away from machine operators; use additional silencers</li> <li>▶ Regularly inspect and perform maintenance on the system in order to ensure that it works properly.</li> </ul>
	<p><b>Careless use of personal protective equipment</b></p> <p>Danger to the operator</p> <ul style="list-style-type: none"> <li>▶ Adapt and wear appropriate personal protective equipment based on the task being performed.</li> </ul>

 <b>WARNING</b>	
	<p><b>System operation by untrained personnel</b></p> <p>Serious personal injury</p> <ul style="list-style-type: none"> <li>▶ The system may only be operated by trained personnel who have read and understood the operating instructions.</li> </ul>
	<p><b>Non-compliance with work safety instructions</b></p> <p>Personal injuries and damage to the system</p> <ul style="list-style-type: none"> <li>▶ Never lift loads at an angle and never drag them.</li> <li>▶ Do not tear off stuck loads.</li> <li>▶ Only pick up and lift suitable loads (check inherent stability and surface density).</li> <li>▶ Only set workpieces down on clear, even surfaces due to the danger of slipping.</li> <li>▶ Do not release the load until it rests completely and safely on a secure surface.</li> <li>▶ Do not come close to the load when releasing/depositing it and do not touch it.</li> </ul>



Error	Possible cause	Solution
Vacuum level is not reached or vacuum is created too slowly	Leakage in hose line	Check hose connections
	Leakage or wear on the sealing plates/sealing	Check the sealing plates/sealing and replace if necessary
	Ejectors are dirty (only FXCB)	Remove and clean ejectors
Load cannot be held	Vacuum level too low	See above for possible causes
	Suction force not suitable for load	Increase vacuum or connect additional grippers if necessary
	Flow restrictors are dirty	Clean the masking film
	The area gripper is not pressed firmly enough onto the workpiece to be lifted	Press the area gripper more firmly onto the surface. On even surfaces, we recommend that the foam compress by at least 50%.
	Too short retention time for the area gripper on the workpiece	Extend the retention time
	Too fast or jerky lifting of workpieces	Optimize the motion. Avoid acceleration peaks (especially when lifting the workpieces)
	The workpieces to be lifted are not suitable for the area grippers (e.g. non-rigid).	Use a different gripping system.
Sealing plate wears out very quickly	The area gripper is angled or makes a grinding noise when applied to the workpiece to be lifted	Set it down vertically on the workpiece
<b>Only FMCB:</b> External vacuum generator works, but workpieces are not picked up	If present: The dust filter of the vacuum generator is dirty	Clean or replace dust filter
	The sealing mat is damaged/torn	Replace sealing mat
	Workpiece is too heavy	Workpiece is not suitable
	Vacuum is too high	Determine the maximum possible vacuum of the vacuum generator; check the system for leaks (hose connections, sealing, etc.); valves are dirty; the workpiece is too porous
	The sealing mat is not applied firmly enough	Press the area gripper more firmly onto the surface. On even surfaces, we recommend that the foam compress by at least around 50%.
<b>Only FXCB:</b> Internal vacuum generator works, but workpieces are not picked up	The sealing mat is damaged/torn	Replace sealing mat
	Workpiece is too heavy	Workpiece is not suitable
	Input pressure is too low	Increase the input pressure. Check the hoses for leakage. The workpiece is too porous
	The ejectors are dirty	Remove and clean ejectors
	The sealing mat is not applied firmly enough	Press the area gripper more firmly onto the surface. On even surfaces, we recommend that the foam compress by at least around 50%.
Solenoid valve is not working	Electrical control is not working	Check the connections and replace valve if necessary
	Solenoid valve is defective	Repair or replace the solenoid valve















### Recommendation

We recommend always performing tests with original sample workpieces. We would be happy to help you with testing.

# 8 Maintenance

## 8.1 General Maintenance Instructions

 <b>CAUTION</b>	
 	<p><b>General notes on maintenance</b></p> <p>Risk of injuries</p> <ul style="list-style-type: none"> <li>▶ The production system must be stopped in the area where the system is being maintained.</li> <li>▶ The system may only be maintained at the workplace in accordance with the operating instructions.</li> <li>▶ The system must be disconnected and depressurized during maintenance work.</li> <li>▶ The production system must be secured to prevent activation during maintenance work.</li> </ul>
 	<p><b>Short-circuit</b></p> <p>Electric shock</p> <ul style="list-style-type: none"> <li>▶ The system must be disconnected during maintenance work.</li> </ul>
	<p><b>Careless use of personal protective equipment</b></p> <p>Danger to the operator</p> <ul style="list-style-type: none"> <li>▶ Adapt and wear appropriate personal protective equipment based on the task being performed.</li> </ul>
	<p><b>Dust and fog</b></p> <p>Reduced visibility/difficulty breathing</p> <ul style="list-style-type: none"> <li>▶ Keep the environment clean wherever possible; avoid kicking up large amounts of dust</li> </ul>
	<p><b>Fumes</b></p> <p>Irritation of the skin and mucous membranes due to cleaning agents</p> <ul style="list-style-type: none"> <li>▶ Observe the safety instructions for using the cleaner in question Use protective equipment if necessary.</li> </ul>
 <b>WARNING</b>	
	<p><b>Risk of injury due to system maintenance by untrained personnel</b></p> <p>Serious personal injury</p> <ul style="list-style-type: none"> <li>▶ The system must only be set up by trained personnel who have read and understood the operating instructions.</li> </ul>

 <span style="font-weight: bold; font-size: 1.2em; margin-left: 10px;">DANGER</span>	
	<p><b>General safety notes on maintenance</b></p> <p>Danger to life and limb</p> <ul style="list-style-type: none"> <li>▶ The system integrator must secure the danger zone.</li> <li>▶ The production system must be stopped in the area where the system is being maintained</li> <li>▶ The system may only be maintained in accordance with the operating instructions.</li> <li>▶ The system must be disconnected and depressurized during maintenance.</li> <li>▶ The production system must be secured to prevent activation during maintenance work.</li> </ul>
	<p><b>Human error</b></p> <p>Danger to life and limb</p> <ul style="list-style-type: none"> <li>▶ Adhere to the operating instructions</li> </ul>

If the exterior of the gripper is dirty, clean with a damp cloth. Operation of the area gripper can draw in dust from the environment. This dust can collect inside the gripper. The gripper must be cleaned regularly, depending on the amount of dust sucked in.

The necessary maintenance intervals can be increased by taking the following measures.

## 8.2 Maintenance Schedule

	Interval				
	Daily	Weekly	Month-ly	Every six months	Annual inspec-tion
Does the vacuum generator make strange noises when a full load is picked up?		X			
Check the ejectors for dirt and clean if necessary			X		
Is the electrical installation still OK? Is the cable screw union secure?				X	
Are the vacuum hoses in good condition (not brittle, not kinked, no worn sections and no leaks)?			X		
Check that all the connections are secure, e.g. the screws, hose clamps, etc.				X	
Are the type plate and maximum load plate still attached to the device?					X
Are the operating instructions available and are the system operators familiar with them?					X
Check all load-bearing parts (e.g. suspension eyes) for deformation, wear, or other damage.			X		
Check the sealing mats for wear, tears and leaks. Replace if necessary.		X			
General condition of the device					X
Leak Test			X		

### 8.3 External Vacuum Generator (only FMCB)

See the relevant operating instructions.

### 8.4 Ejectors (only FXCB)

See the relevant operating instructions.

### 8.5 Cleaning Agents

Use cleaning solvents to clean the device (not petroleum ether or corrosive liquids. Petroleum ether or corrosive liquids destroy the vacuum hoses).

### 8.6 Sealing Plate

Check the sealing plates for wear, tears and leakage on a regular basis and replace them as necessary. The sealing plates must also be replaced if you notice that the vacuum achieved is constantly declining when handling the same parts.

Minimum recommended vacuum: 200 mbar when a workpiece is picked up.

For systems that are designed to require higher vacuum, the minimum vacuum must be adjusted accordingly when the sealing plates are replaced.



The foam may not be cleaned with a compressed-air gun. This would make the foam permeable to air in the places where compressed air was applied. If the sealing plate shows mechanical damage, it can be repaired up to a certain point using standard vulcanizing adhesive (e.g. adhesive for repairing the inner tubes of bicycles).

#### Replacing the sealing plates

- Remove the sealing plate from the quick-change system.
- Check the uncovered masking film for clogged flow restrictors; clean them out with compressed air if necessary.
- Clean the surfaces. In order to maintain optimal hold of the new sealing plate, the surface must be free of dust, oil, oxides and adhesive residues.
- Remove the protective film from the adhesive strip of the new sealing plate.
- Press the sealing plate firmly onto the entire surface without any wrinkles (e.g. with a roller).
- The openings of the sealing plate and flow restrictors must be aligned.
- Processing temperature: a range of +10° C to +40° C is recommended for the object temperature and the ambient temperature.

Video



[www.schmalz.com/  
replacing-sealing-  
foam](http://www.schmalz.com/replacing-sealing-foam)



The sealing mat is asymmetrical. Observe the alignment.



If the gripper is used in a very dirty environment, a sealing plate with filter can be used as an alternative to the standard sealing plate.

## 8.7 Opening the Gripper to Clean the Ejectors (only FXCB)

The gripper must be inspected and maintained regularly in order to ensure that it works optimally. To do so, observe chapter 8.1 General Maintenance Instructions.

**Switch the compressed air, electricity and vacuum generator off in advance.**

1. Check the cable and hose connections. Check for damaged areas, leakage, ensure that the screw unions are tight and that no screws are missing, etc.
2. Use a size 2.5 Allen key to unscrew the four M4x20 and four M4x10 housing screws and then pull the housing cover off upwards.

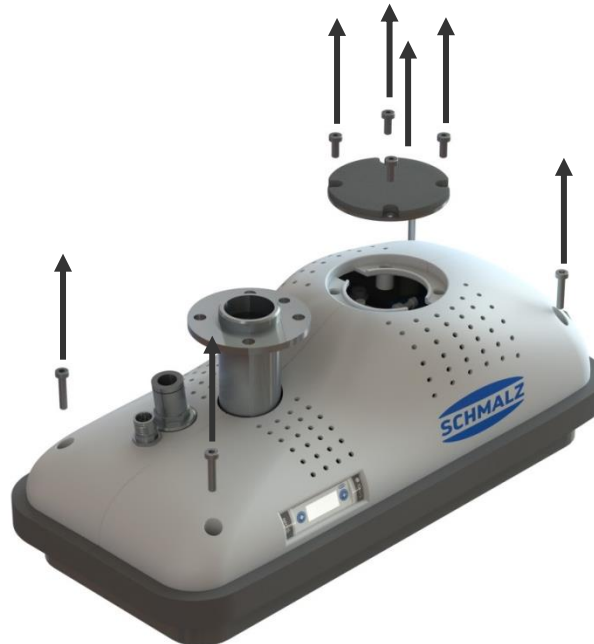

3. Take the two halves of the housing and carefully put them down to the side. Ensure that no hoses or cables on the housing become loose.

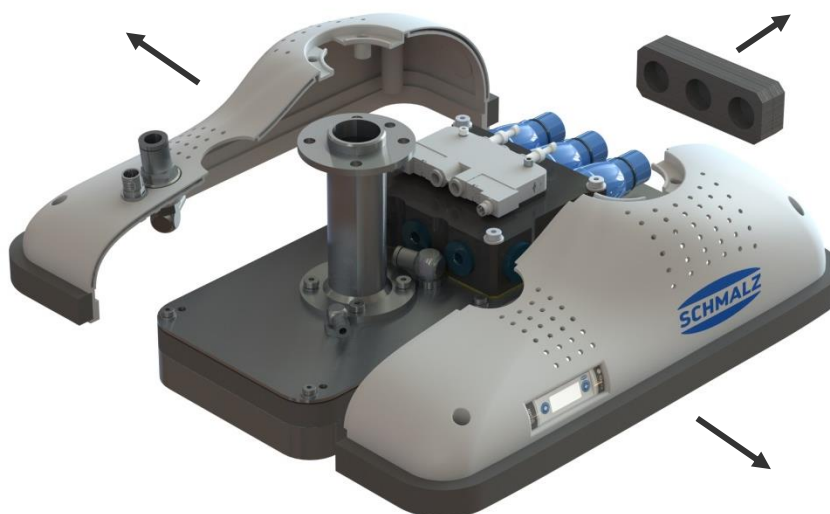

## MAINTENANCE

4. Release and remove the holder cap with a size 12 Allen key.

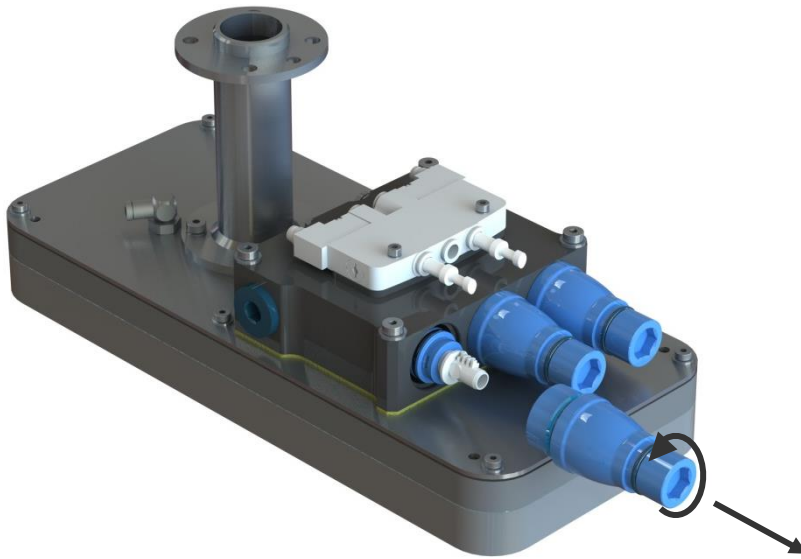

5. Now, remove the ejectors from their mounting bore holes and clean them in accordance with the corresponding operating instructions.

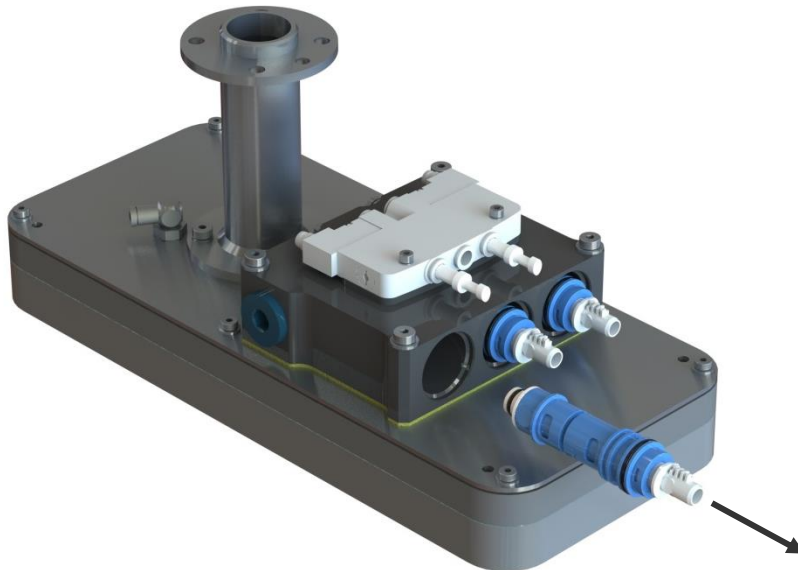

6. Installation is carried out in the reverse order.

## 8.8 Overview of the Tightening Torque of the Screws

See the design from chapter 2.2.

Housing screws (I)	M4x20, steel	1 Nm
Cover screws (B)	M4x10, steel	1 Nm
Ejector holder caps (E)	Allen key, size 12	2 Nm

## 8.9 Mounting the Vacuum Switch in the Housing

To mount the vacuum switch, first connect the electrical cable and vacuum hose. Position the vacuum switch in the opening on the inside of the housing. Now press the vacuum switch into the mount from above until the vacuum switch clicks into place. While doing this, ensure that the vacuum switch display faces forward and does not twist, but rather is pushed straight down from top to bottom. Ensure that the vacuum and electrical connection of the vacuum switch are each on the correct sides.

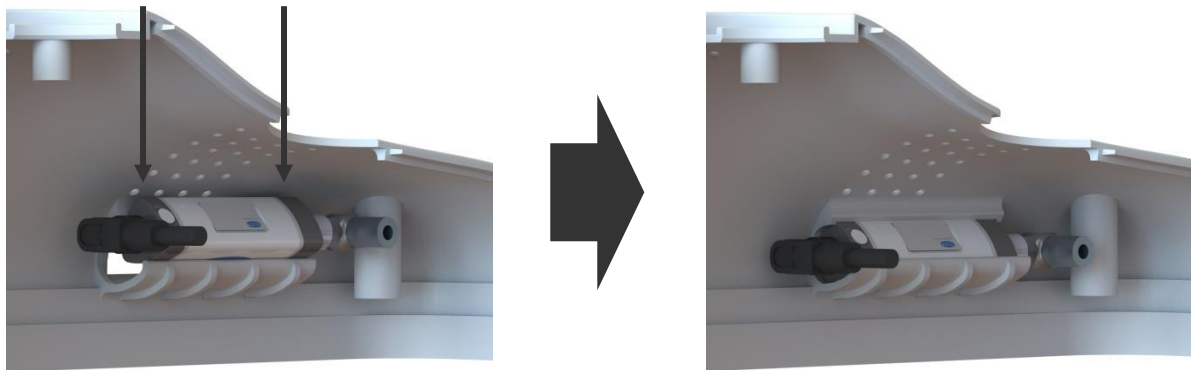

## 8.10 Checking the System for Leaks

The flat suction cup must be ready for operation in order to check the system for leaks. Place the flat suction cups on an even, smooth and airtight surface.

**Only FXCB:** Switch the valve so that the gripper is in the "Suction ON" state. The vacuum level can now be read at the vacuum switch. The measured value may not be lower than  $-475$  mbar.

**Only FMCB:** Switch on the vacuum generator. The vacuum level can now be read at the vacuum switch. The measured value should be up to 10% lower than the maximum reachable vacuum of the vacuum generator used.

Example: The vacuum generator reaches a maximum of  $-0.5$  bar  $\rightarrow$  A vacuum of at least  $-0.45$  bar must be displayed on the gauge.

If the vacuum is not achieved, the system must be checked for leakage as follows.

1. Check the compressed air hoses, hose connections and vacuum hoses (only FMCB) for damage and leakage and replace if necessary.
2. Check the ejectors (only FXCB) for dirt and clean if necessary.
3. Check that the vacuum generator (only FMCB) is fully functional.

## 9 Spare and Wearing Parts

We guarantee this device pursuant to our General Terms and Conditions of Sale and Delivery. The same applies to spare parts, provided that these are original parts supplied by us. We are not liable for any damage resulting from the use of non-original spare parts or accessories. Wearing parts are not covered by the warranty.

<b>ATTENTION</b>	
	<p><b>Incorrect disposal of the system or individual components</b></p> <p>Environmental damage</p> <p>► Disposal according to national guidelines.</p>

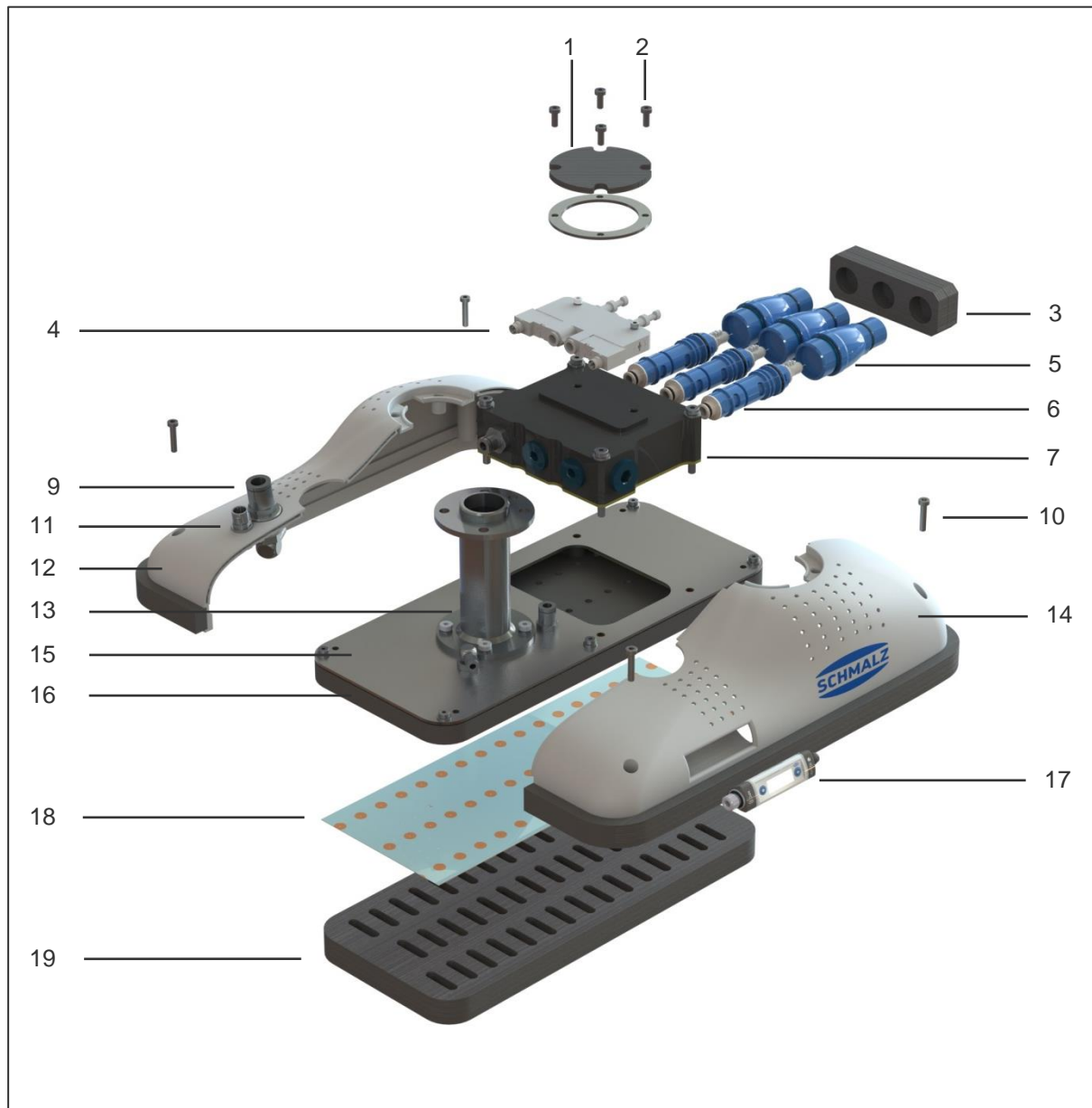



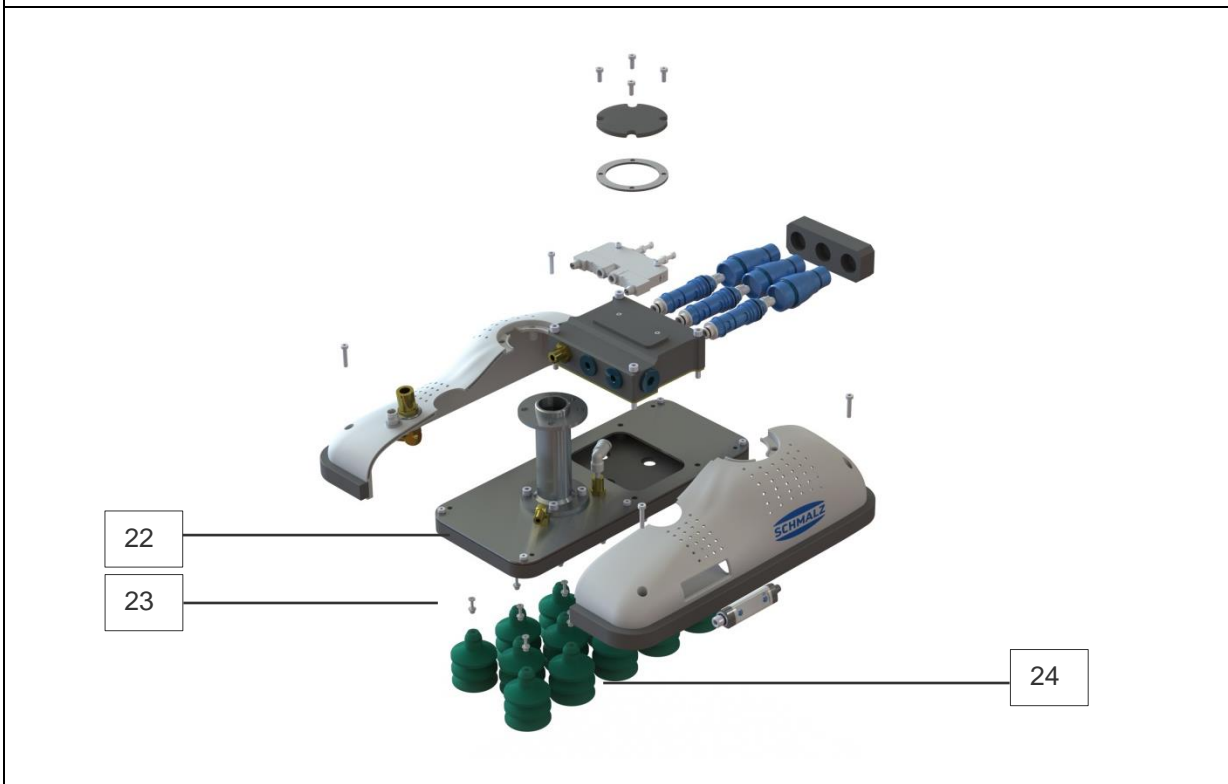
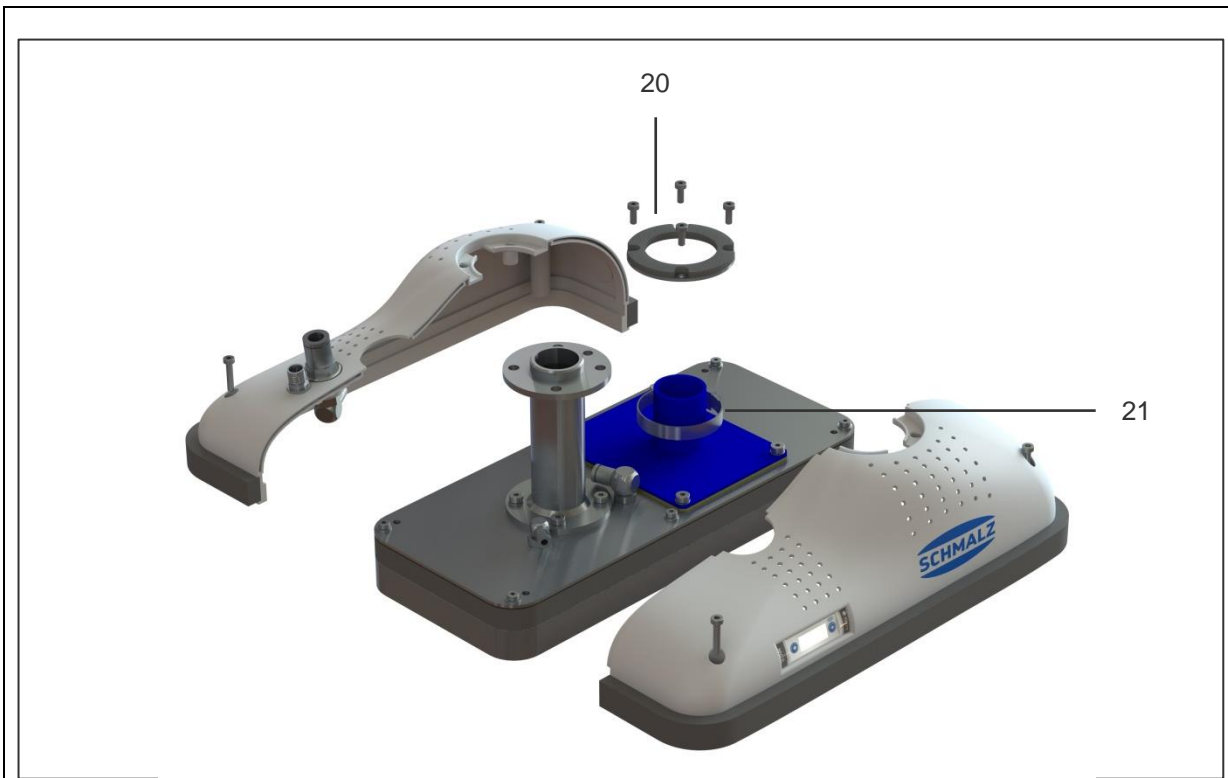

## SPARE AND WEARING PARTS

Item	Quantity	Description	Part no.	Legend
1 <sup>1</sup>	1	Housing cover	10.01.43.00012	S
2	4	Machine screw M4x10	20.01.02.04028	S
3 <sup>1</sup>	1	Silencer	10.01.43.00005	S
4 <sup>1</sup>	1	Solenoid valve	10.01.11.03420	S
5 <sup>1</sup>	3	Holder cap SHC-2-22	10.02.01.01512	S
6 <sup>1</sup>	3	Ejector module SEP HF 2 13 22	10.02.01.01347	S
7 <sup>1</sup>	1	Ejector Block	10.01.11.03497	S
8 <sup>*1</sup>	1	Ejector block (contains items 5, 6 and 7)	10.01.11.03499	S
9	1	Plug-in screw union Ø 10 mm	10.08.02.00251	S
10	4	Machine screw M4x20	20.01.02.04090	S
11	1	Electrical connection plug	21.04.05.00486	S
12	1	Housing (set)	10.01.43.00021	S
13	1	Flange module	Alternative flange patterns, see chapter 5.1	S
14	1	Housing (set)	10.01.43.00021	S
15	1	Cover plate	10.01.11.03626	S
16	1	Suction plate (pre-assembled)	10.01.43.00008	S
17	1	Vacuum Switch VSi	10.06.02.00577	S
18	1	Masking film	10.01.11.03375	S
19	1	Sealing plate	10.01.11.03658	W
20 <sup>2</sup>	1	Housing cover	10.01.43.00009	S
21 <sup>2</sup>	1	Hose clamp assembled	10.01.11.03647	S
22 <sup>3</sup>	1	Suction plate (pre-assembled)	10.01.43.00068	S
23 <sup>3</sup>	15	Flow resistant	10.05.04.00093	S
24 <sup>3</sup>	15	Bellow suction cups	10.01.06.03126	W
25*	0.2 m	Hose Ø 6 mm	10.07.09.00141	S

\* Items not shown







<sup>1</sup> Only FXCB



<sup>2</sup> Only FMCB

<sup>3</sup> only with suction cup version

**S= Spare part, W= Wearing part**

# 10 Accessories

Description	Part number	
Connection cable for Universal Robots UR3,5,10	21.04.05.00350	
Connection cable for KUKA LBR iiwa7,14 MF electrical	21.04.05.00361	
Connection cable for KUKA LBR iiwa7,14 MF pneumatic	21.04.05.00362	
Connection cable with loose strands Length 5000mm	21.04.05.00079	
Vacuum hose Ø 32 mm for connecting the gripper to an external blower (only FMCB)	10.07.09.00036	
Compressed air hose Ø 10 mm for connecting the gripper to the compressed air source	10.07.09.00084	
Solenoid valve for controlling the vacuum (only FMCB)	10.05.02.00068	

<p>Vacuum distributor for operating multiple grippers with one shared blower (only FMCB)</p>	<p>10.01.43.00013</p>	
<p>Vacuum hose Ø 60 mm for connecting the vacuum distributor to an external blower (only FMCB)</p>	<p>10.07.09.00065</p>	

## 11 Pneumatic Circuit Diagram

### 11.1 Pneumatic Circuit Diagram FXCB

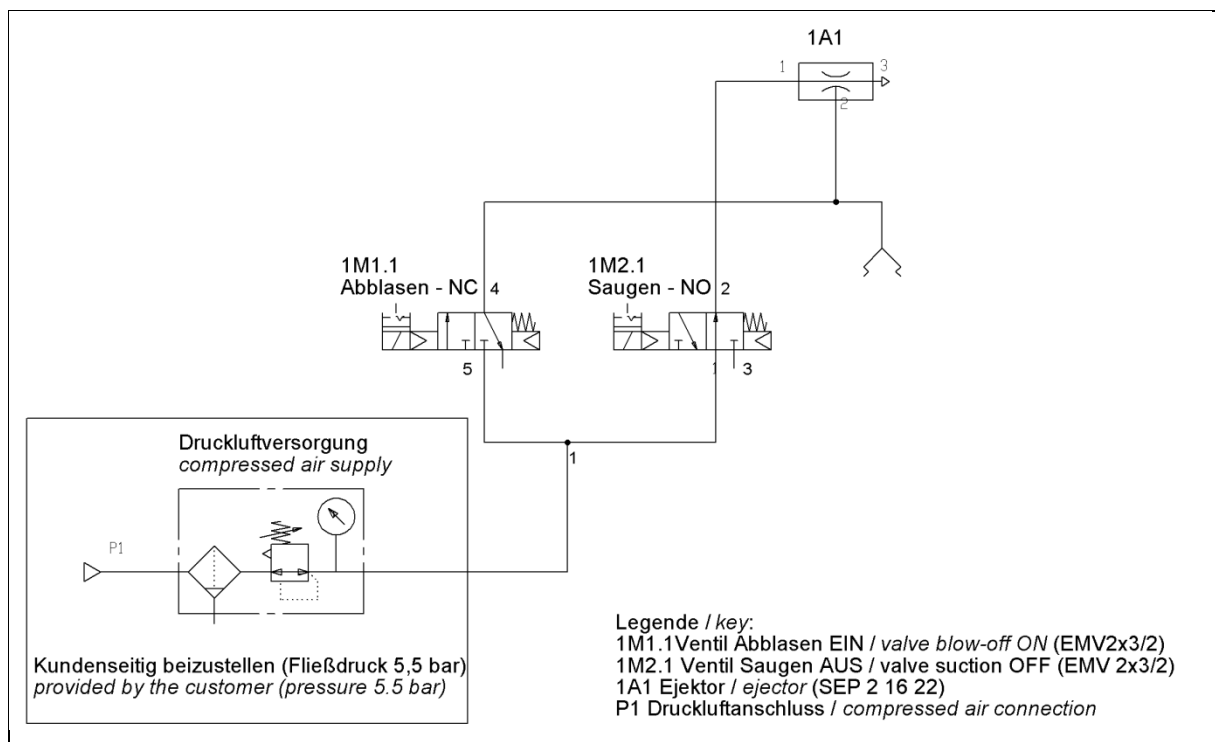

Before initiating the blow-off pulse, ensure that the gripper (with attached workpiece) is not pressed against a solid surface. The workpiece must be able to freely detach from the gripper.



#### Maximum overpressure

The overpressure in the gripper must be limited to a maximum of 0.2 bar. For example, no continuous blow-off pulse as long as the gripper is placed on a workpiece in the waiting position, or similar.

## 11.2 Pneumatic Circuit Diagram FMCB – Parallel Circuit

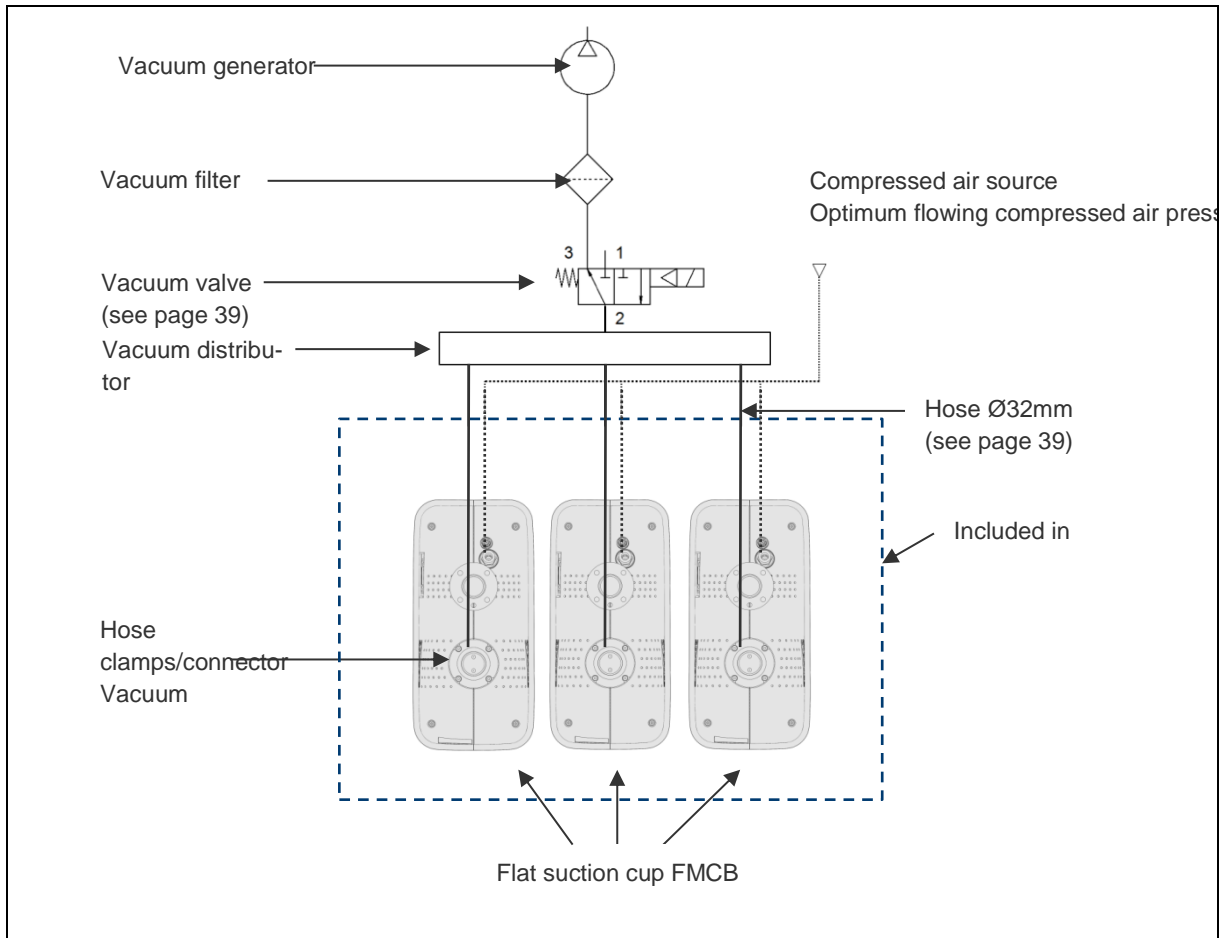

## 12 Other Applicable Documents

EC Declaration of Incorporation FXCB FMCB	30.30.01.01787
Operating instructions for the ejector module ecoPump (only for FXCB)	30.30.01.00600
Operating instructions for the vacuum switch VS <i>i</i>	30.30.01.00956

## At your service worldwide



● **Headquarters**  
Hauptsitz

Schmalz Germany – Glatten

● **Sales and production companies**  
Vertriebs- und Produktionsgesellschaften

Schmalz China – Shanghai  
 Schmalz India – Pune  
 Schmalz Japan – Yokohama  
 Schmalz USA – Raleigh (NC)

● **Sales companies**  
Vertriebsgesellschaften

Schmalz Australia – Melbourne  
 Schmalz Benelux – Hengelo (NL)  
 Schmalz Canada – Mississauga  
 Schmalz Finland – Vantaa  
 Schmalz France – Champs-sur-Marne  
 Schmalz Italia – Novara  
 Schmalz Mexiko – Querétaro

Schmalz Poland – Suchy Las (Poznan)  
 Schmalz Russia – Moskow  
 Schmalz South Korea – Anyang  
 Schmalz Spain – Erandio (Vizcaya)  
 Schmalz Switzerland – Nürens Dorf  
 Schmalz Turkey – Istanbul

● **Sales partners**  
Vertriebspartner

You can find the Schmalz sales partner in your country at:  
[WWW.SCHMALZ.COM/SALESNETWORK](http://WWW.SCHMALZ.COM/SALESNETWORK)

Den Schmalz Vertriebspartner in Ihrem Land finden Sie auf:  
[WWW.SCHMALZ.COM/VERTRIEBSNETZ](http://WWW.SCHMALZ.COM/VERTRIEBSNETZ)

**J. Schmalz GmbH**  
 Johannes-Schmalz-Str. 1  
 72293 Glatten, Germany  
 T: +49 7443 2403-0  
 schmalz@schmalz.de  
 WWW.SCHMALZ.COM