

Manual Version 2.4
Software Version 2.7.1

Doosan Robot

M0609 | M0617 | M1013 | M1509
A0509 | A0509s | A0912 | A0912s
H2017 | H2515

User Manual



Preface	10
Copyright	10
Open Source Software License Information (OSS)	10
Vision License Policy Information	10
1. Product Introduction	11
1.1 Robot Overview	11
1.1.1 Names of Each Part	11
1.1.2 Key Features	12
1.2 Controller Overview	14
1.3 Teach Pendant Overview	16
1.4 Smart Pendant (A-Series)	17
1.5 Emergency Stop Button (A-Series).....	18
1.6 System Configuration.....	19
2. Safety	21
2.1 Safety Indications of User Manual.....	21
2.2 Precautions for Use	22
2.3 Types of Stop Modes for Safety	24
2.4 Emergency Stop	25
2.5 Other Safety Functions	27
2.6 System Power Cut-Off	28
3. Starting Up the Robot	29
3.1 System Power-Up.....	29
3.2 Emergency Stop Button Setting Switch (A-Series)	32
3.3 Booting and Disengaging Packing Position	33
3.3.1 System Booting.....	33
3.3.2 Disengaging Packaging Pose.....	34
3.4 Robot Mode and State	36

3.4.1	Manual Mode.....	36
3.4.2	Automatic Mode.....	37
3.4.3	Other Mode.....	38
3.4.4	Status and Flange LED Color for Each Mode.....	39
3.5	Functional Limits of each Robot Series	41
3.6	Robot Safety Setting.....	42
3.6.1	Safety Limit Setting.....	43
3.6.2	Space Limit and Section Setting.....	44
3.7	Application Recovery Mode Screen	45
3.7.1	Using Application Recovery Mode Functions.....	45
3.8	Series Compatibility Error Screen.....	47
3.8.1	Series Compatibility Error Screen Functions.....	47
4.	Manual Robot Operation.....	48
4.1	Jog Operation.....	48
4.2	Hand-Guiding Operation	49
4.2.1	Teach Pendant Hand-Guiding Button.....	49
4.2.2	Cockpit Button (five buttons).....	50
4.2.3	Cockpit Button (six buttons).....	52
4.2.4	Exit Cockpit.....	54
4.3	Robot Teaching and Execution	55
5.	System Operation Program Outline.....	56
5.1	Status Display Area.....	57
5.2	Work Screen Area	58
5.3	Main Menu.....	59
6.	Home Screen Overview	60
6.1	Task Execution and Stopping.....	62

6.2	Load Saved Tasks.....	63
6.3	Tool Setting.....	64
7.	Workcell Manager.....	66
7.1	What is a Workcell Item?.....	66
7.2	Add Workcell Item.....	68
7.3	Deprecated Workcell Item.....	69
7.4	Unavailable Workcell Items.....	71
7.5	Robot Setting.....	72
7.5.1	World Coordinates Setting.....	74
7.5.2	Robot Limits Setting.....	77
7.5.3	Safety I/O Setting.....	80
7.5.4	Normal I/O Setting.....	84
7.5.5	Safety Stop Modes Setting.....	86
7.5.6	Robot Installation Pose Setting.....	87
7.5.7	Tool Shape Setting.....	89
7.5.8	Tool Weight Setting.....	90
7.5.9	User Coordinates Setting.....	92
7.5.10	Nudge Setting.....	93
7.5.11	Space Limit and Section Settings Overview.....	94
7.5.12	Space Limit Settings.....	97
7.5.13	Collaborative Workspace Settings.....	98
7.5.14	Protection Section Settings.....	99
7.5.15	Collision Sensitivity Reduction Section Settings.....	100
7.5.16	Tool Direction Change Limit Section Settings.....	101
7.5.17	Custom Section.....	102
7.6	End Effector Setting.....	104
7.6.1	Grippers and Tools.....	104
7.6.2	End Effector I/O Signal Setting.....	106
7.6.3	End Effector I/O Testing.....	107
7.6.4	Tool Center Point(TCP) Setting.....	108

7.6.5	Tool Center Point Setting based on Other End Effectors.....	110
7.7	Machine Tool Setting.....	112
7.8	Peripheral Setting.....	113
7.8.1	Others.....	116
7.8.2	Vision.....	117
8.	Task Builder.....	118
8.1	Task Management.....	118
8.1.1	Create New Task.....	118
8.1.2	Template.....	119
8.1.3	Save Task.....	120
8.1.4	Save Task As.....	121
8.1.5	Editing Workcell Items.....	122
8.1.6	Save Task on External Storage Device.....	123
8.1.7	Load Saved Tasks.....	124
8.1.8	Delete Saved Tasks.....	125
8.1.9	Import Tasks on External Storage Devices.....	126
8.2	Task Builder Commands.....	127
8.3	Deprecated Skill Command.....	130
8.4	Edit Task.....	131
8.4.1	Edit Task Screen Configuration.....	132
8.4.2	Add Command.....	134
8.4.3	Delete Command.....	135
8.4.4	Paste command.....	136
8.5	Setting and Applying Command Properties.....	137
8.6	Motion Command Property Setting.....	138
8.6.1	Waypoint Setting.....	138
8.6.2	Speed Setting.....	139
8.6.3	Program Link Mode Setting.....	140
8.6.4	Blending Mode Setting.....	141

8.6.5	Multi-Segment (Waypoint) Setting.....	142
8.7	Skill Command Property Setting	143
8.7.1	Understanding Basic Principles of Skill Commands.....	143
8.7.2	Compliance Control and Contact Check.....	146
8.7.3	Skill Command Work Point Setting with Cockpit Buttons.....	148
8.8	Execute Task Program	149
8.8.1	Virtual mode screen.....	149
8.8.2	Real Mode Screen: End Effector Information tab.....	151
8.8.3	Real Mode Screen: I/O Information Tab.....	153
8.8.4	Execute Task.....	155
9.	Task Writer.....	156
9.1	Task Management.....	156
9.1.1	Create New Task.....	156
9.1.2	Save Task.....	157
9.1.3	Save Task As.....	158
9.1.4	Save Task on External Storage Device.....	159
9.1.5	Load Saved Tasks.....	160
9.1.6	Delete Saved Tasks.....	161
9.1.7	Import Tasks on External Storage Devices.....	162
9.1.8	Export Task to External Storage Device.....	163
9.2	Edit Task Program.....	164
9.3	Task Writer Command.....	165
9.4	Setting and Applying Command Properties	168
9.5	Execute Task Program	169
9.6	Debug Screen.....	170
10.	Monitoring and Testing.....	171
10.1	Screen Layout.....	171
10.2	I/O Status Check	173
10.2.1	Controller/Flange Digital Input Check.....	173

10.2.2	Controller Analog Input Check.....	174
10.2.3	Controller/Flange Digital Output Setting.....	175
10.2.4	Controller Analog Output Setting.....	176
10.3	I/O Test.....	177
10.4	Modbus Test.....	178
10.5	Servo On	179
10.6	Backdrive Mode	180
10.7	Safety Recovery Mode.....	181
10.7.1	Using Software Recovery Mode.....	182
10.7.2	Packaging Mode Setting.....	183
11.	Jog Function.....	184
11.1	Jog Screen.....	185
11.1.1	Execute based on Joint.....	187
11.1.2	Execute based on Robot Base.....	188
11.1.3	Execute based on World Coordinates.....	189
11.1.4	Execute based on Robot Tool.....	190
11.2	Movement Screen	191
11.2.1	Moving with Angle Setting.....	192
11.2.2	Move with Base Reference Coordinates.....	193
11.2.3	Move with World Coordinates Reference Coordinates.....	194
11.2.4	Move with Tool Reference Coordinates.....	195
11.3	Setting Screen.....	196
11.3.1	Alignment based on Base Axis/World Axis.....	197
11.3.2	Go to Home.....	198
11.3.3	Alignment based on Target.....	199
11.3.4	Alignment based on Workcell Items.....	201
12.	Environment Setting	202
12.1	Language Setting	202

12.2 Date and Time Setting	203
12.3 Robot Setting	204
12.3.1 Robot Home Position Setting.....	204
12.3.2 Cockpit Setting.....	205
12.3.3 Remote Control Setting.....	206
12.3.4 Smart Pendant Setting.....	208
12.4 Change and Disable Password.....	210
12.5 User Role Setting.....	211
12.6 Network Setting	212
12.6.1 User-defined Modbus Support Function Code.....	212
12.6.2 Register User-defined Modbus.....	213
12.6.3 Register Preset Modbus.....	214
12.7 System Update.....	215
12.7.1 Unified Update.....	215
12.7.2 System Restore.....	217
12.8 Check and Enter Robot License Code	218
12.9 Check Log.....	219
12.9.1 System Log.....	219
12.9.2 Extract Log.....	220
12.10 Factory Reset	221
12.10.1 Delete Log.....	221
12.10.2 License Type and Factory Reset Range according to Vision Connection.....	222
12.11 Screen Saver Mode Setting	223
12.12 Idle Servo Off	224
12.13 Friction Calibration.....	225
12.14 KT Smart Factory Setting Screen	226
12.15 Backup & Restore.....	227
12.16 Workcell & Skill Installation and Removal	230
13. Smart Pendant (A Series)	231
13.1 Functions of Smart Pendant	231

13.2 Smart Pendant Robot LED Color	233
--	-----

Annex A. Upper/Lower Threshold Range and Default Value of Safety Parameters 234

A.1 M1509	234
A.2 M1013	235
A.3 M0617	236
A.4 M0609	237
A.5 A0509, A0509S	238
A.6 A0912, A0912S	239
A.7 H2515	240
A.8 H2017	241

Preface

This User Manual introduces robot work management and operation methods.

The contents of this manual are current as of the date this manual was written, and product-related information may be modified without prior notification to the user.

Copyright

The copyright and intellectual property rights of the contents of this manual are held by Doosan Robotics. It is therefore prohibited to use, copy, or distribute the contents without written approval from Doosan Robotics. In the event of abuse or modification of the patent right, the user will be fully responsible for the consequences.

While the information in this manual is reliable, Doosan Robotics is not responsible for any damage that occurs due to errors or typos. The contents of this manual may be modified according to product improvement without prior notification.

This is a detailed manual for a specific software version of the robot. For details on updated manuals, refer to the Robot LAB website (<https://robotlab.doosanrobotics.com/>).

© 2021 Doosan Robotics Inc., All rights reserved

Open Source Software License Information (OSS)

The software installed in this product was developed based on free/open source software.

Details about the free/open source software license can be found on the OSS use page on the Doosan Robotics website (www.doosanrobotics.com/kr/oss/license).

For related inquiries, contact the Marketing Department of Doosan Robotics (marketing.robotics@doosan.com).

Vision License Policy Information

If a registered Vision license is removed, the Vision category and all Vision-related items on the New Peripheral list in the WCM become hidden.

Various Vision-related items in different locations of the teach pendant, such as Vision Preview, become hidden.

If an unregistered Vision license is registered, the hidden Vision category and all Vision-related items on the New Peripheral list in the WCM are displayed. Various Vision-related items in different locations of the teach pendant, such as Vision Preview, are displayed.

If a registered Vision license is removed and re-registered, and if the initial Vision license registration created Vision-related items, setting a non-Vision license and re-registering the Vision license will display the Vision-related items created during the initial registration.

1. Product Introduction

1.1 Robot Overview

1.1.1 Names of Each Part

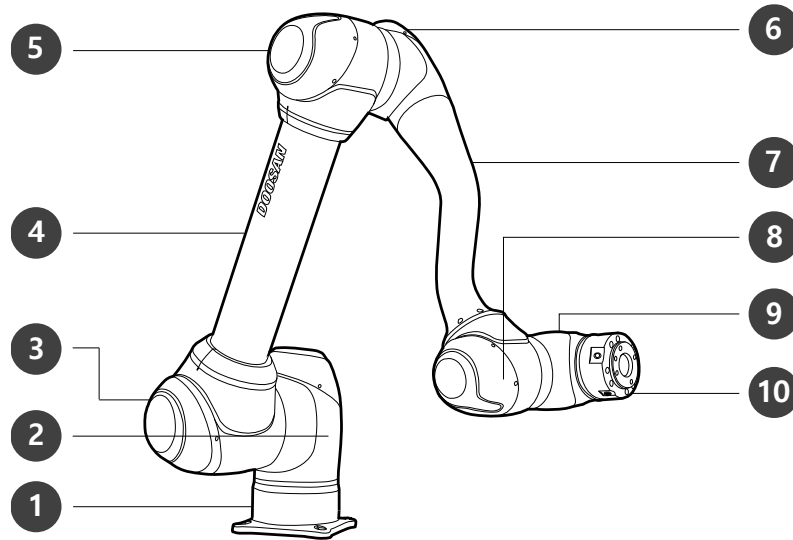

No.	Name	No.	Name
1	Base	6	J4
2	J1	7	Link2
3	J2	8	J5
4	Link1	9	J6
5	J3	10	Tool Flange

1.1.2 Key Features

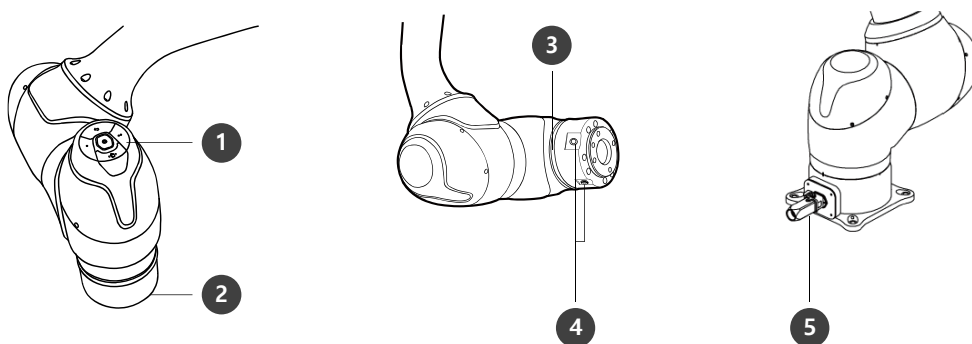

No.	Item	Description
1	Cockpit	[Option] Controller used for direct teaching.
2	Tool Flange	Area to install tools.
3	Flange LED	Displays the robot status with different colors. For more information about robot status, refer to the “ 3.4.4 Status and Flange LED Color for Each Mode. ”
4	Flange I/O	I/O port for tool control. (Digital input 3ch, output 3ch)
5	Connector	Used for supplying power to and communication of the robot.

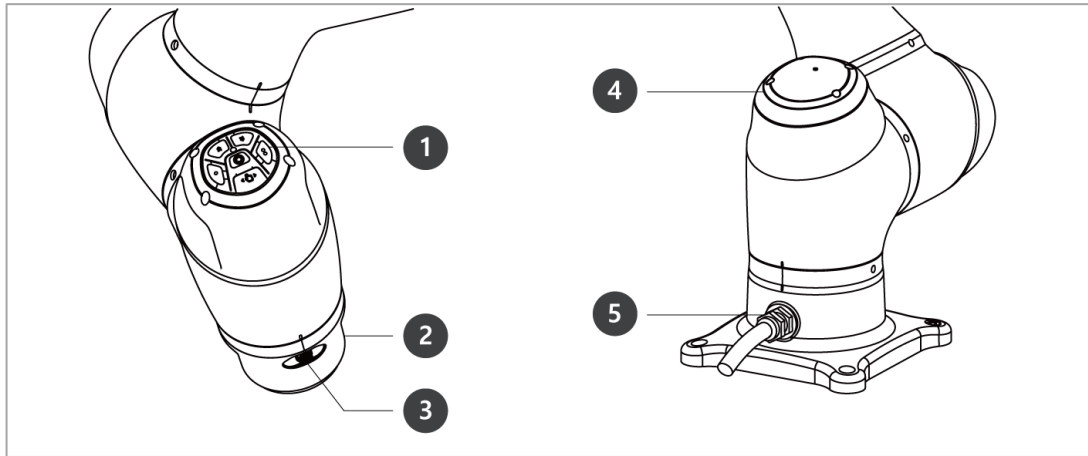

No.	Item	Description
1	Cockpit	[Option] Controller used for direct teaching.
2	Tool Flange	Area to install tools.
3	Flange I/O	I/O port for tool control. (Digital input 2ch, output 2ch)
4	LED (1-axis)	Displays the robot status with different colors. For more information about robot status, refer to the “ 3.4.4 Status and Flange LED Color for Each Mode ”
5	Connector	Used for supplying power to and communication of the robot.

1.2 Controller Overview

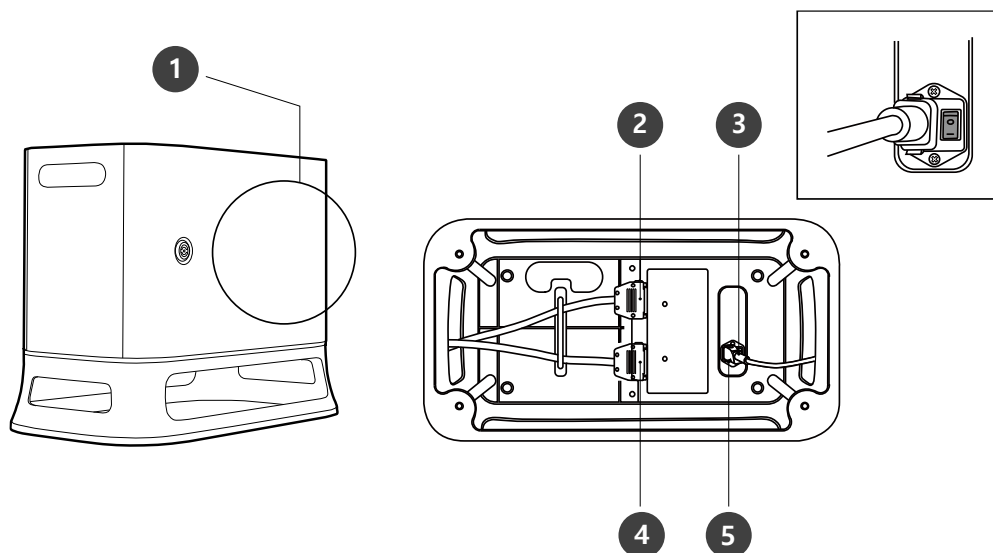

No.	Item	Description
1	I/O connection terminal (internal)	Used to connect the controller or peripherals.
2	Teach pendant cable connection terminal	Used to connect the teach pendant cable to the controller.
3	Power switch	Used to turn ON/OFF the main power of the controller.
4	Robot cable connection terminal	Used to connect the robot cable to the controller.
5	Power connection terminal	Used to connect the controller power supply.

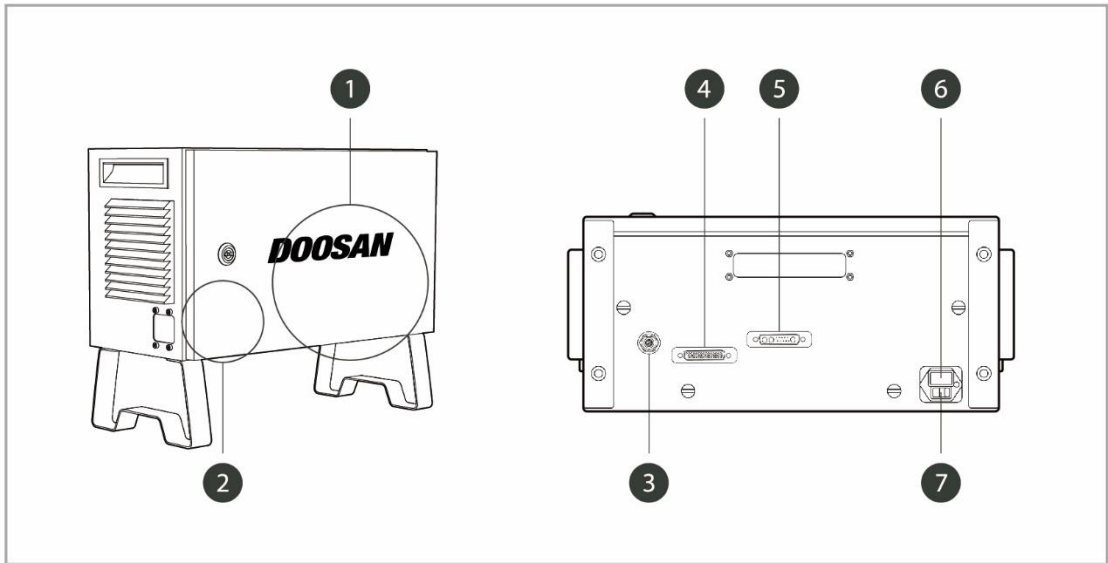

No.	Item	Description
1	I/O connection terminal (internal)	Used to connect the controller or peripherals.
2	Emergency Stop Button Setting switch	To use the Teach Pendant, Smart Pendant, or Emergency Stop buttons, the switch must be set to match the actual configuration.
3	Emergency stop button and smart pendant connection terminal	Connects the emergency stop button or smart pendant cable to the controller.
4	Teach pendant cable connection terminal	Used to connect the teach pendant cable to the controller.
5	Robot cable connection terminal	Used to connect the robot cable to the controller.
6	Power connection terminal	Used to connect the controller power supply.
7	Main power switch	Used to turn ON/OFF the main power of the controller. For more information, refer to 3.1 System Power-Up .

1.3 Teach Pendant Overview

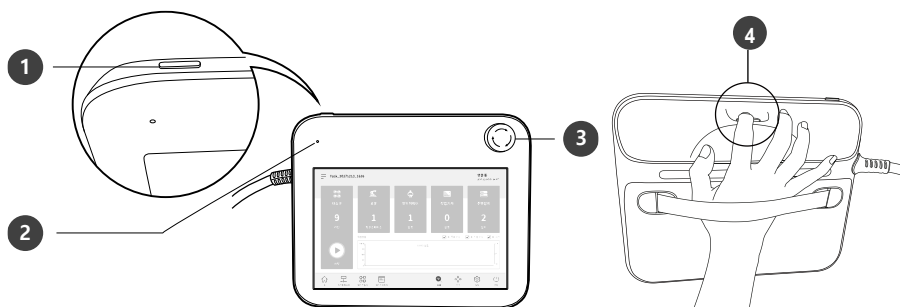

No.	Item	Description
1	Power Button	Used to turn ON/OFF the main power of the teach pendant. For more information, refer to 3.1 System Power-Up
2	Power LED	Turns ON when power is supplied.
3	Emergency stop button	In case of an emergency, press the button to stop robot operation.
4	Hand-Guiding button	Press and hold the button to move the robot freely into a desired pose.

Version A Series

※ The teach pendant is not a standard item but an optional item, so it must be purchased separately

1.4 Smart Pendant (A-Series)

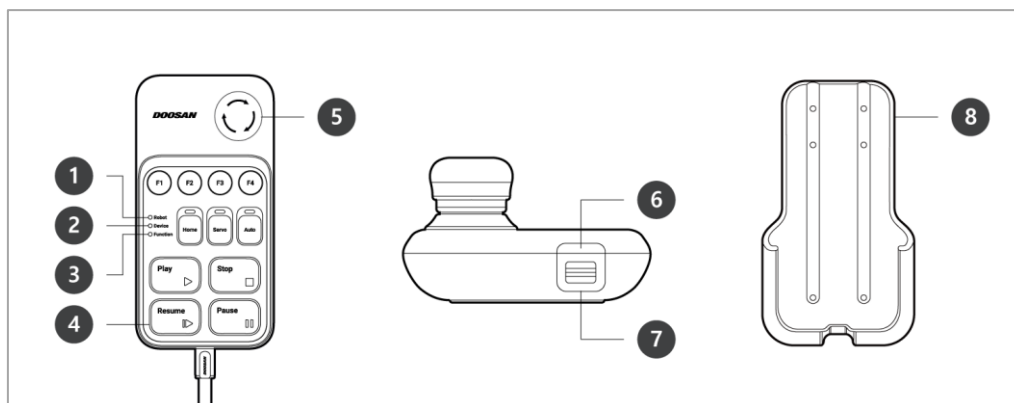

No.	Item	Description
1	Robot LED	Used to indicate the robot status by displaying the same color as the robot status LED to the user.
2	Device LED	Used to indicate whether the system entered smart pendant mode.
3	Function LED	When four input signal buttons (F1 to F4) are pressed, the LED lights up and indicates the press status
4	Buttons	There are a total of 11 buttons including four input signal buttons (F1-F4) for each function, home, servo, auto, play, stop, resume and pause.
5	Emergency Stop Button	In case of an emergency, press the button to stop robot operation.
6	Power Button	Used to turn ON/OFF the main power of the smart pendant.
7	Strap Anchor	Used to add a strap to the device.
8	Holder bracket	Install the holder bracket on a wall to store the smart pendant.

※ The smart pendant is not a standard item but an optional item, so it must be purchased separately

1.5 Emergency Stop Button (A-Series)

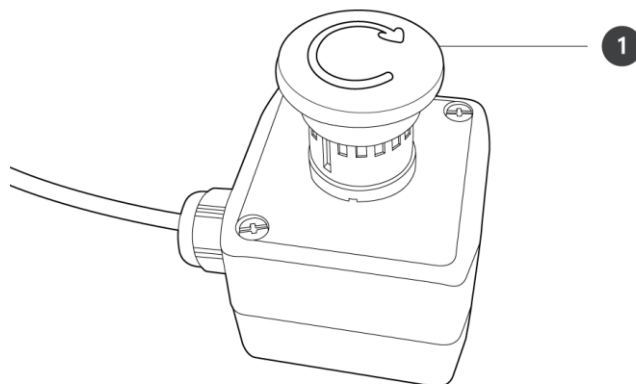

No.	Item	Description
1	Emergency Stop Button:	In case of an emergency, press the button to stop robot operation.

1.6 System Configuration

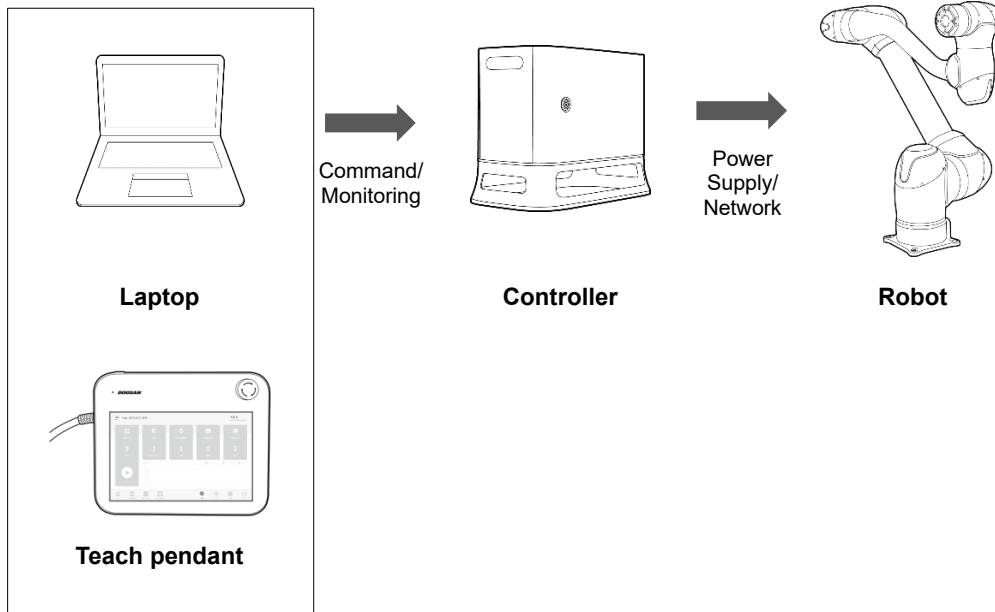

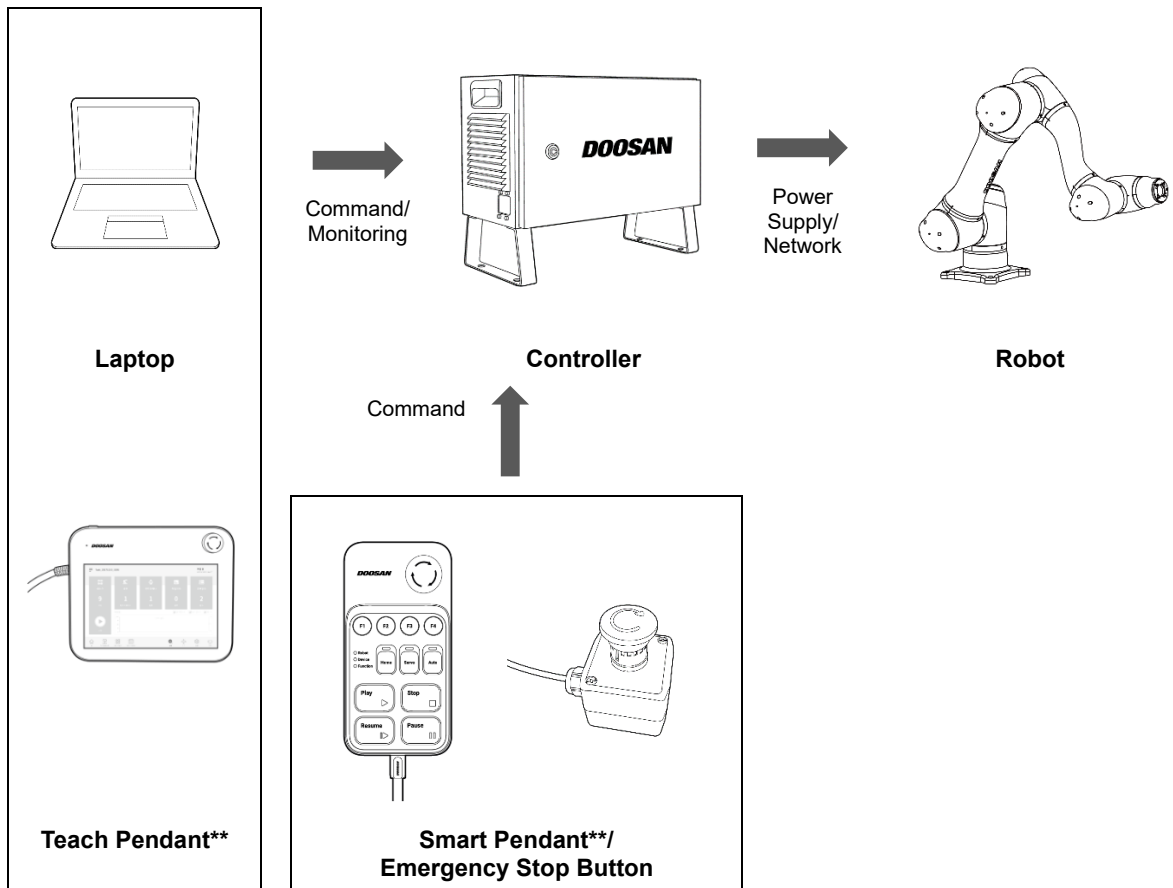

- **Laptop:** After installing the DART Platform, a work environment identical to the teach pendant can be set up.
- **Teach Pendant:** It is a device that manages the overall system, and it is capable of teaching the robot specific poses and setting robot and controller related settings.
- **Controller:** It controls the robot's movement according to the pose or movement set by the teach pendant. It features various I/O ports that allow the connection and use of various equipment and devices.
- **Robot:** It is an industrial collaborative robot that can perform transport or assembly tasks with various tools.



- **Laptop:** After installing the DART Platform, a work environment identical to the teach pendant can be set up.
- **Teach Pendant**:** This is a device that manages the overall system, and it is capable of teaching the robot specific poses and setting the robot and items related to the installation of the controller and robot. (purchased separately as an option)
- **Controller:** It controls the robot's movement according to the pose or movement set by the teach pendant. It features various I/O ports that allow the connection and use of various equipment and devices.
- **Smart Pendant**:** The robot can be easily controlled using a pendant capable of performing simple functions such as turning on the servo ON/OFF or executing/closing preset programs. (purchased separately as an option)
- **Emergency Stop Button:** If a laptop is used as part of the system, it acts as the emergency stop button of the teach pendant.
- **Robot:** It is an industrial collaborative robot that can perform transport or assembly tasks with various tools.

2. Safety

2.1 Safety Indications of User Manual

 Danger	Failure to observe instructions with this symbol may result in serious accidents that could result in death or serious injury to the operator.
 Warning	Failure to observe instructions with this symbol may result in accidents that cause severe injury to the operator.
 Caution	Failure to observe instructions with this symbol may result in product damage or cause injury to the operator.

2.2 Precautions for Use

Danger

- Do not operate the robot if the robot is abnormal. The user may be injured.
- Do not put fingers inside the controller with power supplied. Live cables are connected, which may lead to electrocution or injury.
- Do not modify the robot. Doosan Robots is not responsible for for any issues that occur due to unauthorized modification.
- Do not enter the robot's operation area or touch the robot when it is operating. This may lead to colliding with the robot, resulting in damage to the robot or injury to the individual.

Warning

- Make sure to read and understand the manuals for all equipment installed.
- To prevent accidents by getting caught by the robot, do not wear loose clothing or accessories when operating the robot. Tie long hair to prevent accidents with hair getting caught by the robot.
- The surfaces of the robot and controller are hot during operation due to the heat generated, so do not handle or touch these surfaces during or immediately after operation. Failure to do so may result in burns.
- If excessive heat is generated by the robot, turn off the robot and wait for an hour.
- Before operating the robot, comprehensive risk assessment must be performed.
- Safety-related parameters must be determined through the comprehensive risk assessment, and safety parameter settings and the operation of safety functions must be verified before operating the robot.
- Hand-guiding must only be used if risk assessment approves its use.
- If an error occurs on the controller or the teach pendant, activate the emergency stop function, identify the cause of the error, find the error code on the log screen and contact the supplier.

Caution

- Take caution of the robot's movement when using the teach pendant. Failure to do so may lead to colliding with the robot, resulting in damage to the robot or injury to the individual.
- Collision with an object generates considerable kinetic energy, leading to dangerous situations. This energy is proportionate to the speed and payload. (Kinetic Energy = $1/2 \text{ Mass} \times \text{Speed}^2$)
- Combining different machines may increase existing risks or create new risks. When a robot is integrated into a system, perform risk assessment of the entire system.
- If different safety levels and emergency stop performance levels are required, always select the higher level.
- If a machine that can cause damage to the robot is integrated, it is recommended to individually test all functions and robot programs.
- It is recommended to test the robot program by designating temporary waypoints outside another machine's work space. Doosan Robotics is not responsible for damages that occur due to

programming error or robot malfunctioning, as well as damage to the equipment.

- Do not expose the robot to strong magnetic fields. This may damage the robot or cause malfunctions.
- For information about additional modules, refer to corresponding manuals.

2.3 Types of Stop Modes for Safety

The stop modes provided to ensure user safety are as follows:

- **Safe Torque Off (STO):** All Stop Modes corresponding to Stop Category 0 immediately cut off power and force operation with brake operation only. The brake is used for maintaining the current pose when driving force is lost (i.e., power off, etc.) not for deceleration. Using STO can result in brake wear or decelerator durability loss, so it is recommended to use SS1 unless necessary.
- **Safe Stop 1 (SS1):** All joints are stopped with maximum deceleration by a Stop Mode corresponding to Stop Category 1, the power supply to the motor is cut off, and the brake is engaged to stop. Power is cut off after deceleration, and like STO, the robot can be operated after releasing the stop function and setting the Servo On. For more information about servo on methods, refer to "10.5 Servo On".
- **Safe Operating Stop (SOS):** The current position is maintained with power supplied to the motor and the brake disengaged (Servo ON). STO is set if abnormal position change is detected.
- **SS2 (Safe Stop 2):** All joints are stopped with maximum deceleration by a Stop Mode corresponding to Stop Category 2, and Safe Operating Stop (SOS) is engaged.
- **RS1:** If a collision is detected, Floating Reaction : a function to comply with external force for 0.25 second at the moment collision is detected, is engaged to respond to external force, and Safe Operating Stop (SOS) is engaged.
- If SS2 and RS1 mode are set during program execution, select "STOP" or "RESTART" on the teach pendant screen to stop or restart the program. If the robot end (TCP) is within the Collaborative Workspace and if the Nudge function is enabled, the user can apply force to the robot directly (Nudge) to restart work. For more information, refer to "7.5.13 Collaborative Workspace Setting"

2.4 Emergency Stop

In emergency situations, press the Emergency Stop button on the top right of the teach pendant to immediately stop the system.

- Twist the Emergency Stop button clockwise to disengage the emergency stop condition.

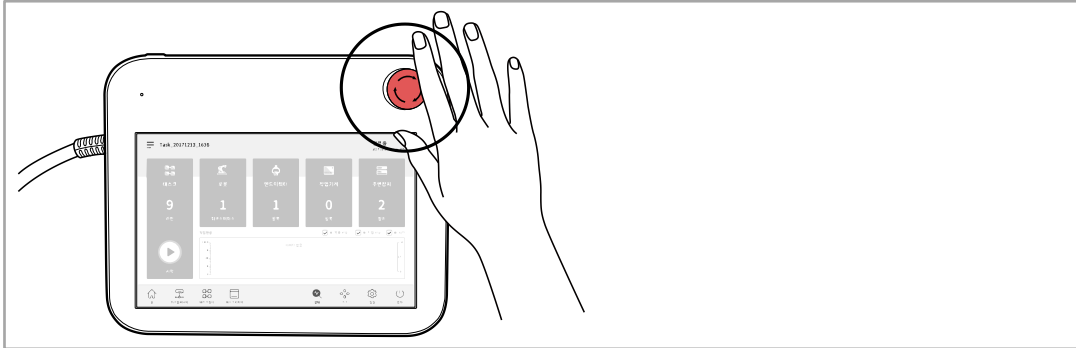

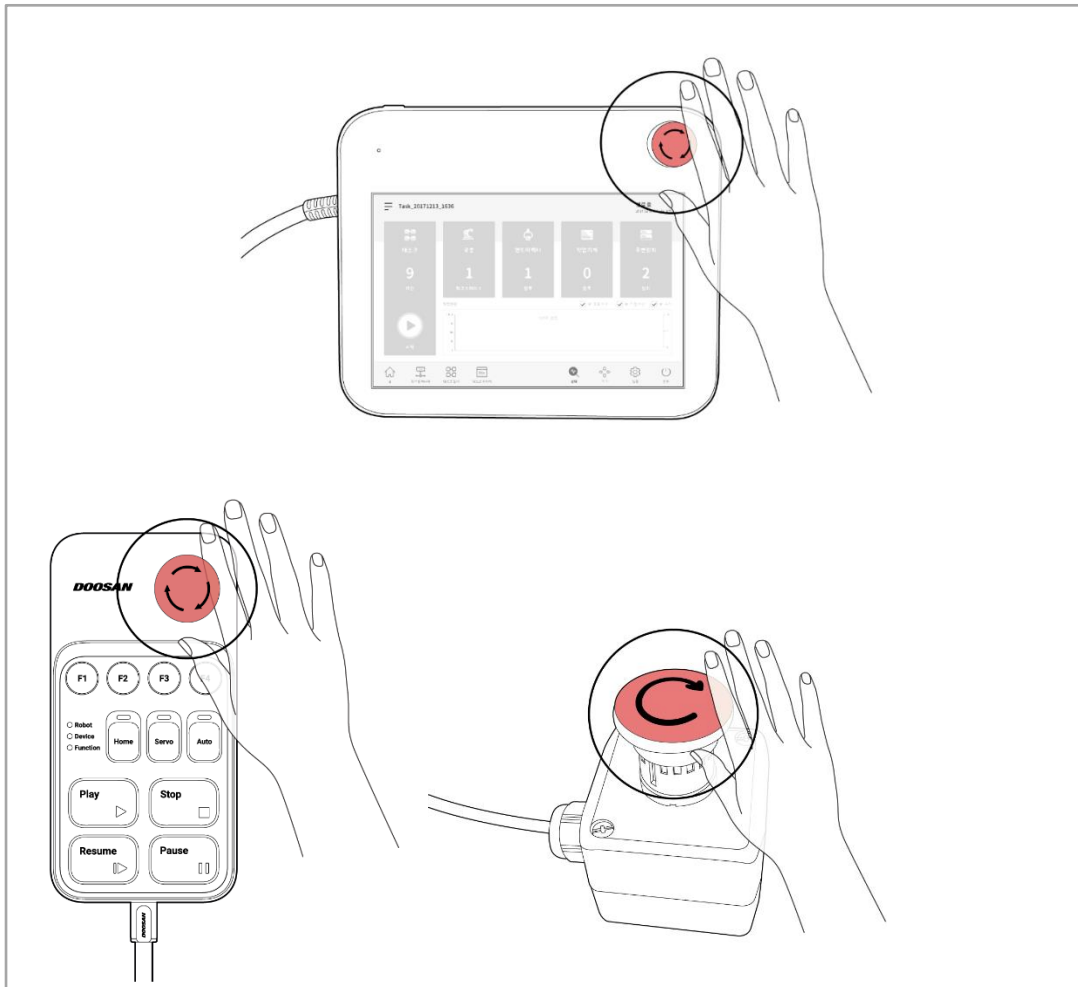

Note

- Safe Stop 1 (SS1) is set as the default mode for the Emergency Stop button.
- If additional Emergency Stop buttons are needed, a button can be added to the Controller after a risk assessment.
- Emergency stop must not be used as a risk reduction method, but as a secondary protection device.
- If additional Emergency Stop buttons are needed, an application risk assessment must be performed. The Emergency Stop button must comply with IEC 60947-5-5.
- If an emergency stop occurred through the port set at Safety I/O, the button capable of accessing the screen for Safety Input setting at the bottom of the emergency stop popup window is enabled.

2.5 Other Safety Functions

The system offers Safety Recovery Mode and Backdrive Mode for user safety and robot recovery.

- **Safety Recovery Mode:** If there is an error with a continuing safety violation or if a robot is to be packed, the user can use Safety Recovery Mode to configure the position and angle of the robot. For more information about Safety Recovery Mode, refer to “**10.7 Safety Recovery Mode.**”
- **Backdrive Mode:** The system controls the robot joint with only the brake and without power driving the motor. This function is used when the robot cannot return to normal with Safety Recovery mode or Hand-guiding. With Backdrive mode, the user can engage or disengage the brake of each joint. For more information about Backdrive Mode, refer to “**10.6 Backdrive Mode**”

2.6 System Power Cut-Off

A power switch is installed on the bottom of the controller to cut off system power. Before cleaning or servicing the robot or controller, or before disassembling the system, cut off system power using the power switch.

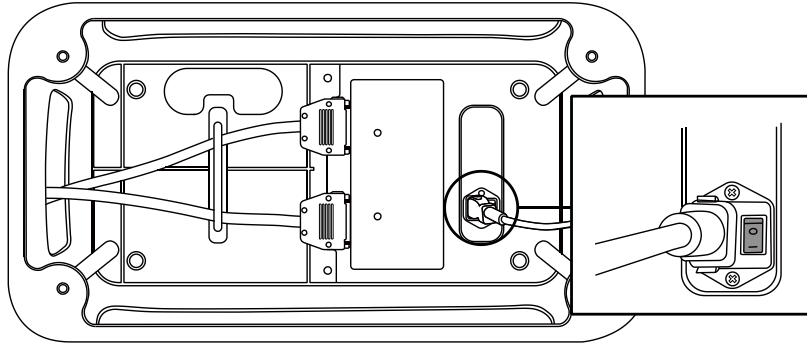

Version A Series

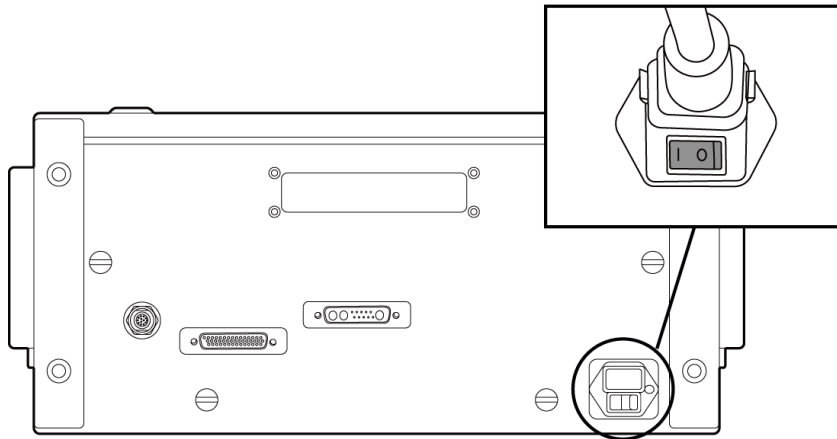

3. Starting Up the Robot

3.1 System Power-Up

Press and hold the power button on the upper left of the teach pendant.

- The power for systems such as the robot, controller and teach pendant is turned on.
- Once the system is powered on, the LED indicator for the robot lights up.
- To turn off the power, press and hold the button again.

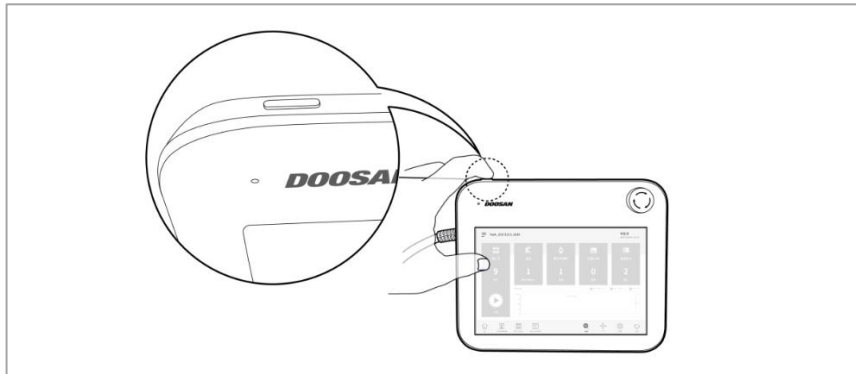

Note

If the system does not power up, check the power switch at the bottom of the controller.

Version A Series

Press the power button at the bottom of the controller.

- The power for systems such as the robot, controller, teach pendant and smart pendant is turned on.

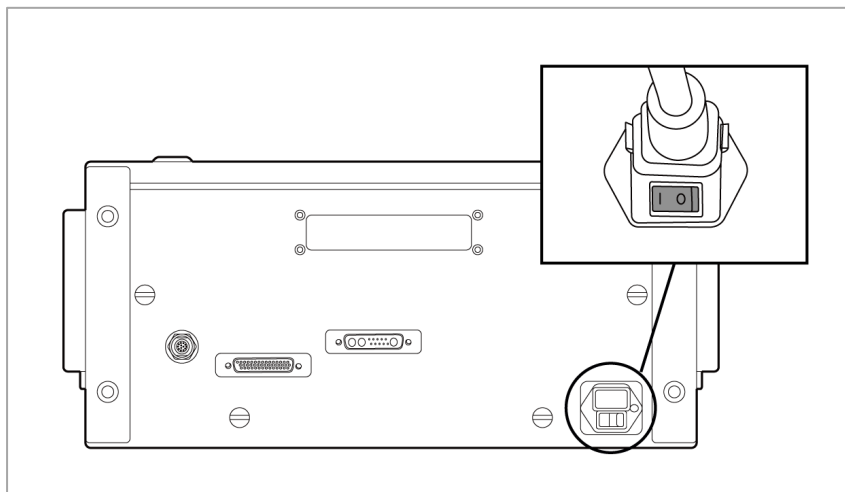

[PC Power ON/OFF only when E-STOP Box is used - Standard Item]

Open the controller door, and press and hold the power button located below the bottom right of the Safety board.

- To turn off the power, press and hold the button.

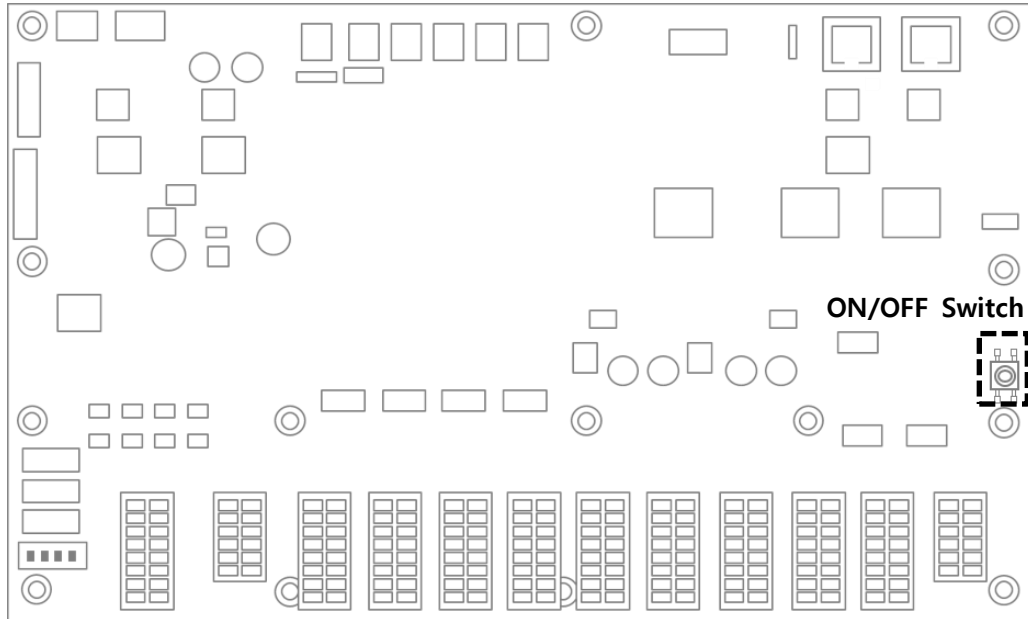

[PC Power ON/OFF when Teach Pendant is used - Optional Item]

Press the Power button located on bottom right of the Teach Pendant screen.

Press and hold the power button located on the top left of the teach pendant.

- To turn off the power, press and hold the button again.

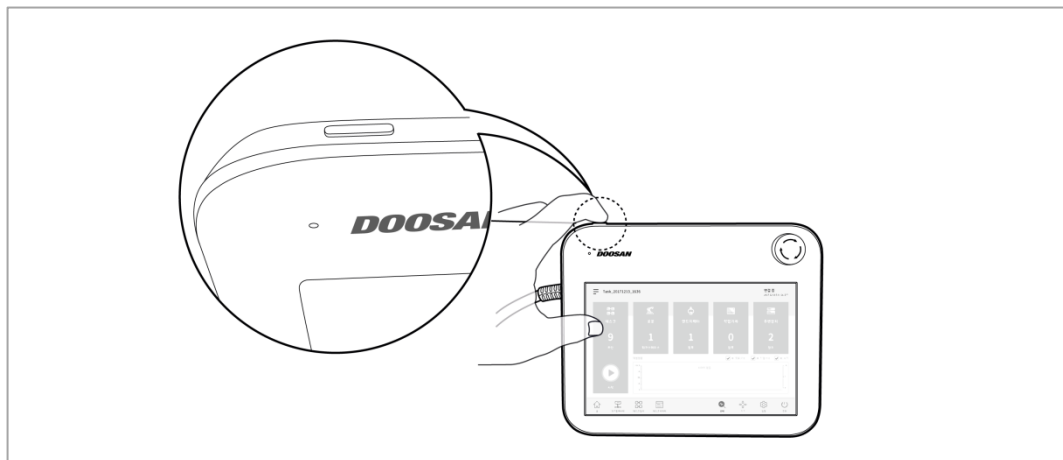

[PC Power ON/OFF when Smart Pendant is used - Optional Item]

Press and hold the power button on the upper left of the smart pendant.

- To turn off the power, press and hold the button again.

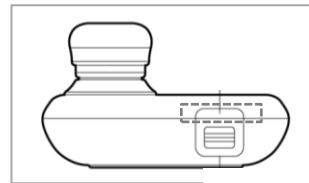
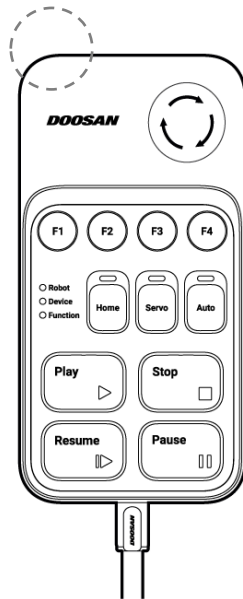

Note

If the system does not power up, check the power switch at the bottom of the controller.

3.2 Emergency Stop Button Setting Switch (A-Series)

Configure the EMERGENCY STOP BUTTON SETTING switch on the Case according to components and additional components before connecting and starting up the product. If the setting is not configured according to the guide, the robot will not operate properly.

The EMERGENCY STOP BUTTON SETTING switch is located on the bottom left of the board inside the controller door (refer to below).

Configure the setting according to the components as follows. Upon first receiving, the setting is configured as Case 1.

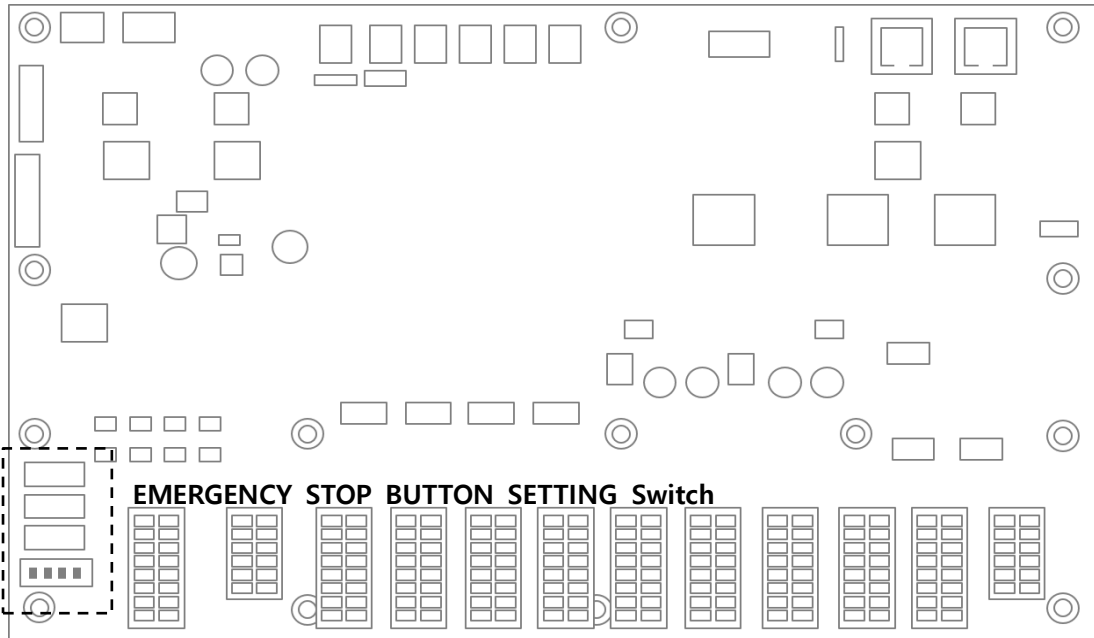

Case 1	1. Teach Pendant(O), Smart Pendant(O)	On	<input type="checkbox"/>	<input type="checkbox"/>	<input type="checkbox"/>	<input type="checkbox"/>
	2. Teach Pendant(O), Emergency Stop Button(O)	Off	<input checked="" type="checkbox"/>	<input checked="" type="checkbox"/>	<input checked="" type="checkbox"/>	<input checked="" type="checkbox"/>
	3. Use of all					
Case 2	1. Smart Pendant(O), Teach Pendant(X)	On	<input checked="" type="checkbox"/>	<input checked="" type="checkbox"/>	<input type="checkbox"/>	<input type="checkbox"/>
	2. Emergency Stop Button(O), Teach Pendant(X)	Off	<input type="checkbox"/>	<input type="checkbox"/>	<input checked="" type="checkbox"/>	<input checked="" type="checkbox"/>
Case 3	Teach Pendant(O), Smart Pendant(X),	On	<input type="checkbox"/>	<input type="checkbox"/>	<input checked="" type="checkbox"/>	<input checked="" type="checkbox"/>
	Emergency Stop Button(X)	Off	<input checked="" type="checkbox"/>	<input checked="" type="checkbox"/>	<input type="checkbox"/>	<input type="checkbox"/>

 **Warning**

- If the setting of the emergency stop button setting is different from the actual configuration, the emergency stop button does not work and the user may be injured in an emergency situation.

3.3 Booting and Disengaging Packing Position

3.3.1 System Booting

After the system is powered on, the system boots up. When booting is complete, the system application is displayed on the teach pendant. For more information about the system application, refer to “5 System Operation Program Outline”.

Note

- **Servo On:** In order to move the robot's pose, the robot must be in servo on status where power is supplied to joints of the robot and the robot is on standby. For more information about servo on, refer to “10.5 Servo On.”
- **Date and Time Setting:** The date and time displayed on the teach pendant and the log message saved on the robot follow the date and time setting of the system, so the date and time must be configured at initial boot up. For information regarding how to configure the date and time, refer to “12.2 Date and Time Setting”.
- Using the DART Platform allows robot control without the teach pendant.
- The DART Platform displays a screen that shows the robot connected to the network after booting, and the process of checking the robot's serial number and connecting to the robot take place on this screen.

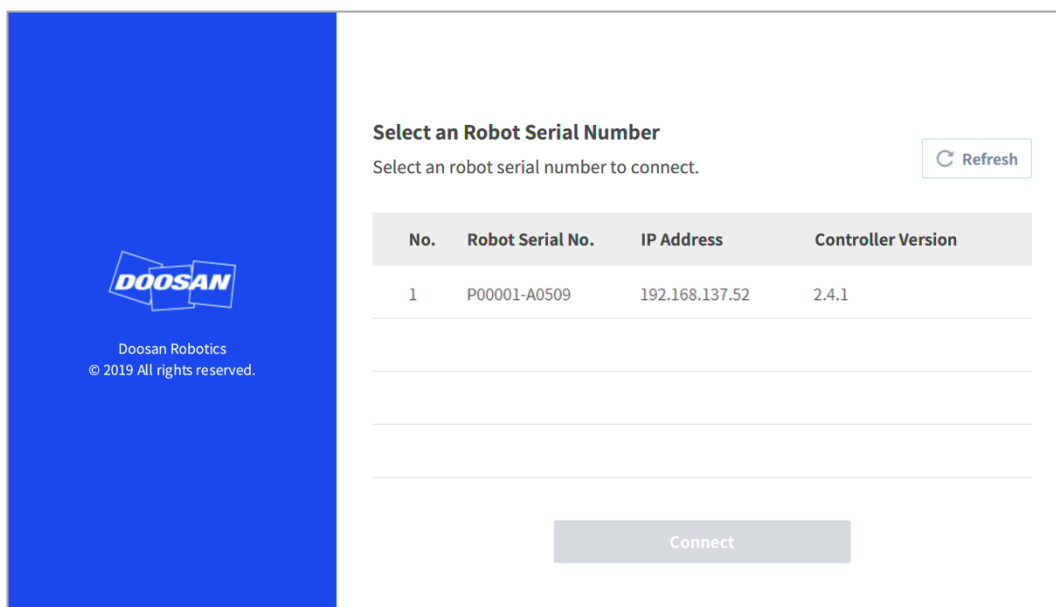

3.3.2 Disengaging Packaging Pose

The robot is in its packaging pose to allow easy transportation or packaging. To use the robot, it is necessary to disengage the packaging pose.

Disengaging Packaging Pose:

- 1 Tap **Status** on the initial screen of the teach pendant.



- 2 Tap the **Safety Recovery** button. The **Safety Recovery** button is enabled when **Safety Off** is set.

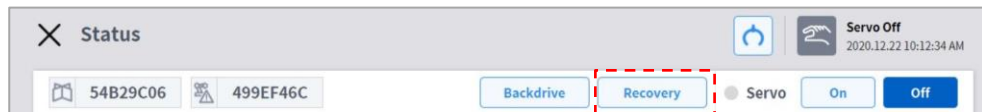

- 3 Select the **Packaging Mode** tab.

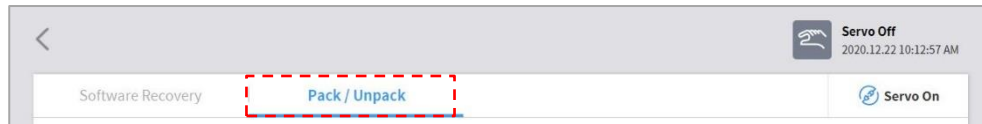

- 4 Tap the **Servo On** button.

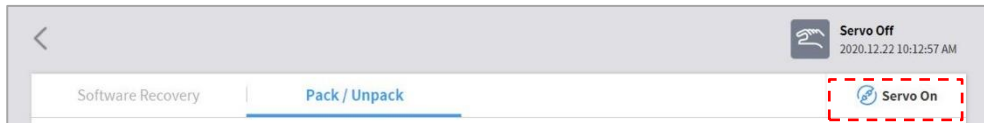

- 5 The robot status display on the top right of the Teach Pendant screen shifts from "Safety Off" to "Recovery Standby." Tap the **Packaging Mode** toggle button on the **Packaging Mode** tab.



- 6 Tap the **Disengage Packaging Pose** button.
 - The robot's packaging mode is disengaged, and the robot moves to the home position. When the robot is in the home position, it does not move any further.

- 7 After the robot is in the home position, tap the  button on the top left of the screen.



- 8 The robot status display on the bottom right of the screen changes from **Recovery** to **Standby**.

The robot is now in a state where the user can operate it. Press the **Close** button on the  **Status** screen to close the status window.

3.4 Robot Mode and State

The operation modes of the robot consist of Manual Mode, where the user controls the robot directly, and Auto mode, where the robot operates without direct user control.

3.4.1 Manual Mode

This is the mode in which the robot operates according to direct user control. The robot only operates when a button related to an action is pressed, and releasing the button results in stopping the corresponding action.

- In Manual Mode, the TCP movement speed is limited to less than 250 mm/s according to the Robot Safety Regulations. However, during Handguiding, the TCP speed and joint speed are limited to less than the thresholds of Reduced status set in **WCM > Robot > Robot Limits**
- If risk assessment results indicate that a 3-position Enable Switch is necessary, the 3-position Enable Switch can be connected through the I/O by the setting in the **WCM > Robot > Safety I/O**. In this case, the Enable Switch must be placed in the center-enable position to allow robot operation in Manual Mode and Servo On.
- In Manual Mode, it is possible to configure robot peripherals in the Workcell Manager or to program robot tasks in Task Builder and Task Writer, and if the robot cannot be operated normally for reasons such as the robot exceeding the safety threshold, the Recovery function can be performed to restore normal operation.

3.4.2 Automatic Mode

This is the mode in which the robot operates without direct user control. The robot will execute the programmed task or predefined sequence with a simple operation command and without additional user input.

Task Builder or **Task Writer** can verify the programmed task in virtual mode, execute it in actual operation, and perform robot tool weight and auto weight center measurement functions.

- If risk assessment results indicate that a 3-position Enable Switch is necessary, the 3-position Enable Switch can be connected through the I/O by the setting in the **WCM > Robot > Safety I/O**. In this case, the Enable Switch must be placed in the center-enable position to allow Play or Start, Resume and Servo On in Automatic Mode.

3.4.3 Other Mode

Unlike normal modes such as manual mode and automatic mode, this is exceptional mode.

This mode includes special states such as controller booting, initializing and states related to Backdrive at which you can push robot by hand without drive power..

3.4.4 Status and Flange LED Color for Each Mode

Mode	State	Description	Flange and/or Base LED
Manual	Manual Standby	<ul style="list-style-type: none"> This is the default status of teaching. Workcell Manager, Task Builder and Task Writer can be used to configure the work condition or perform task programming. It monitors the stop status with Safe Operating Stop (SOS). 	Blue
	Manual Jogging	<ul style="list-style-type: none"> The jog function is used to operate the robot. 	Blue Blinking
	Manual Handguiding	<ul style="list-style-type: none"> The robot can be operated manually during teaching. 	Cyan Blinking
	Recovery Standby	<ul style="list-style-type: none"> Recovery in progress. All safety functions except for axis and TCP speed monitoring are disabled during recovery. It monitors the stop status with Safe Operating Stop (SOS). 	Yellow Blinking
	Recovery Jogging	<ul style="list-style-type: none"> The jogs of each axis can be used to correct the exceeded safety threshold. 	Yellow Blinking
	Recovery Handguiding	<ul style="list-style-type: none"> The robot can be moved directly by hand to correct the exceeded safety threshold. 	Yellow Blinking
	Safety Stop	<ul style="list-style-type: none"> The system stopped due to protective stop or exceeding the safety threshold. It monitors the stop status with Safe Operating Stop (SOS). 	Yellow

Mode	State	Description	Flange and/or Base LED
Auto	Auto Standby	<ul style="list-style-type: none"> The Teach Pendant UI is in the actual mode execution screen in a single work space. Pressing the "Execute" button will execute the task program. White is displayed for a Standalone Zone, green is displayed for a Collaborative Zone. 	White/Green
	Auto Running	<ul style="list-style-type: none"> The task program is being executed. White is displayed for a Standalone Zone, green is displayed for a Collaborative Zone, and white and yellow are displayed by turns for a High Priority Zone 	White Blinking / Green Blinking / ss White and yellow Flashing alternately
	HGC (HandGuide Control) Standby	<ul style="list-style-type: none"> The Handguiding command is executed during task program execution. The system waits until the user presses the "Handguiding" button. It monitors the stop status with Safe Operating Stop (SOS). 	Cyan
	HGC Running	<ul style="list-style-type: none"> The robot pose can be changed by pressing the 	Cyan Blinking

Mode	State	Description	Flange and/or Base LED
		<p>"Handguiding" button.</p> <ul style="list-style-type: none"> After the robot stops, enter HGC End & Resume signal through the Safety IO to set Auto Running and then continue executing the task program. 	
	Auto-measure	<ul style="list-style-type: none"> The weight and center of gravity point of the end effector are measured automatically. Please note that the safety monitoring functions of the robot are disabled during auto-measuring. 	Yellow Blinking
	Safety Stop	<ul style="list-style-type: none"> The system stopped due to protective stop or exceeding the safety threshold. It monitors the stop status with Safe Operating Stop (SOS). 	Yellow
	Servo Off	<ul style="list-style-type: none"> The servo is off due to protective stop, emergency stop or exceeded safety threshold. It is identical to Safe Torque Off (STO). 	Red (M/H-Series) LED Off (A-Series)

Mode	State	Description	Flange and/or Base LED
	Backdrive Hold	<ul style="list-style-type: none"> All brakes of 6 joints are engaged, and Backdrive motion is locked. 	Yellow Blinking
	Backdrive Release	<ul style="list-style-type: none"> Break of one or more joint(s) is released due to the selection of brake release. The brake(s) will not lock by itself. Use caution as the robot and/or end-effector may fall unless all brakes are engaged again. 	Yellow Blinking
	Backdrive Servo Off	<ul style="list-style-type: none"> The servo is off due to emergency stop or exceeded joint speed threshold during Backdrive Motion. It is identical to Safe Torque Off (STO). 	Red (M/H-Series) LED Off (A-Series)
	Initializing	<ul style="list-style-type: none"> The controller is booting and the robot is initialized. 	Red Blinking

3.5 Functional Limits of each Robot Series

The different robot series (A, As, M/H Series) limit the use of functions as follows:

- **Current-based:** Current of motor located on each joint is used.
- **FTS-based:** An FTS (force torque sensor) located on the end of the robot is used.
- **JTS-based:** JTS (joint torque sensors) located on each joint is used.

Features	A Series (Current-based)	A Series S (FTS-based)	M Series (JTS-based)	H Series (JTS-based)
Direct Teaching - Free Motion	O	O (Current-based)	O	O
Direct Teaching - Restrained Motion	X	O	O	O
Collision Detection	O	O (Current-based)	O	O
Installation Pose Measurement	X	O	O	X(the robot can only be installed on the floor)
Tool Weight Measurement	X	O	O	O
Workpiece Weight Measurement	X	O	O	O
Nudge Function	X	X	O	O
Force Control	O (setting available only in three translation directions, excluding rotation)	O	O	O
Compliance Control	O (setting available only in three translation directions, excluding rotation)	O	O	O

3.6 Robot Safety Setting

The following safety settings must be configured before operating the robot for the first time after installation.



Warning

Safety-related parameters must be determined through the comprehensive risk assessment, and safety parameter settings and the operation of safety functions must be verified before operating the robot.

3.6.1 Safety Limit Setting

For more information about the universally applied safety limit, refer to “**7.5.2 Robot Limits Setting**”.

3.6.2 Space Limit and Section Setting

For more information about the spatial limit which limits the work space of the robot and the zone settings for configuring safety limits for each zone, refer to “**7.5.11 Space Limit and Section Settings Overview**”.

3.7 Application Recovery Mode Screen

If a software error is detected during robot booting, the system enters Application Recovery Mode. This screen offers functions to preserve and restore application data. This screen is only available in English.

3.7.1 Using Application Recovery Mode Functions

Application Recovery Mode

An error occurred while running Application. If the symptoms are repeated after restarting, restore the system using the provided recovery function.

2
View Error Log

1

Robot Serial No. XXXXXX-MXXXX

i [Preserve] The functions below are for data retention. Make sure to Download backup data and system logs with USB.

3
System Log Export

4
Backup Database

i [Troubleshoot] The functions below will return to the initialized robot. To use the function, you must enter the safety password.

5
Clean Database

7
Delete 3rd-Party Workcell

9
Integration Update

6
Restore Database

8
System Restore

10
Controller Restart

No.	Item	Description
1	Robot Serial Number	This displays the serial number of the connected robot.
2	View Error Log	This displays the log of errors that triggered recovery mode.
3	Export System Log	This executes a function to extract the system log. The log from 2 days prior to the present day is extracted.
4	Database Backup	This executes a function to back up the database of the connected robot. Data backed up using this function can only be restored with the Restore Database function on this screen.

No.	Item	Description
5	Reset Database	This executes a function to reset the database of the connected robot to its default state.
6	Restore Database	This restores the database using the file created with the Database Backup function on this screen.
7	Delete 3rd Party Workcell Item	This deletes 3rd party Workcell Items installed via " 0 Workcell & Skill Installation and Removal "
8	Restore System	This restores the application to a specific version. It works the same as " 12.7.2 System Restore " function.
9	Unified Update	If the update fails, the system can be re-installed using the Unified Update function.
10	Restart	This restarts the controller.

3.8 Series Compatibility Error Screen

The controller stores the execution information of the connected robot. This information varies depending on the robot series, so if a robot of a different series is connected, the series compatibility error screen will be displayed. This screen provides the options of saving the current execution information or resetting the data. This screen is only available in English.

3.8.1 Series Compatibility Error Screen Functions

Controller & Robot Compatibility Error

The software installed on the controller and the software of the currently connected robot series do not match, so it cannot boot normally.

Compatibility Test Result

1 Controller S/W
A Series

2 Robot
M Series

i Reconnect with the same robot series as the software series installed on the controller.

i Alternatively, if you want to use the currently connected robot series, press the 'Clean Database' button below to delete the data installed on the controller and use it.

i 'Clean Database' will erase all Workcell Manager Data entered by the user. For safe operation, you should be backup database first using USB and then clean database.

3 Backup Database

4 Clean Database

Controller Power Off

No.	Item	Description
1	Controller S/W	This displays the robot series information for the execution data saved in the controller.
2	Robot	This displays information on the newly connected robot series.
3	Database Backup	This executes a function to back up the database of the connected controller. The backup file can be used to restore data through “ 12.15 Backup & Restore. ”
4	Reset Database	This executes a function to reset the database of the connected controller. To connect a robot of a series different from the current controller information, a reset must be executed.

4. Manual Robot Operation

4.1 Jog Operation

The robot can be operated manually using the Jog function on the teach pendant. For more information about the jog function, refer to “**11 Jog Function.**”

4.2 Hand-Guiding Operation

The user can change the robot's pose by directly moving the robot. Use the Hand-guiding button on the teach pendant or use the cockpit located on joint J6 to change the robot's pose.



Caution

- Before entering the robot's operation range, press the Hand-guiding button on the teaching pendant one or two times to make sure that the robot does not move when no external force is applied.
- If a tool is installed on the tool flange, configure the tool weight on the Workcell Manager and Jog screens on the teach pendant before changing the robot pose. If the Hand-guiding button is pressed without configuring the tool weight, the robot may move abruptly.
- When using tools whose center of gravity are far away from the flange too much (400 mm or more), the robot can generate unstable vibrations. In such cases, operate the robot manually using the jog function rather than with Hand-guiding.

4.2.1 Teach Pendant Hand-Guiding Button

The user can change the robot's pose while holding down the Hand-guiding button located on the back of the teaching pendant.

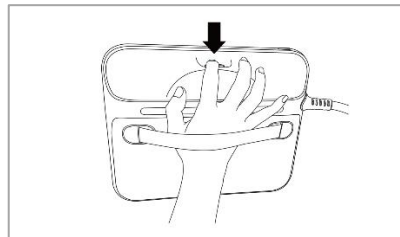

Note

By default, the Hand-guiding button can only be used in Manual mode, and it cannot be used in Auto mode when the task programs of **Task Builder** and **Task Writer** are operating. However, if the robot is set to the Hand-guiding Ready state with the Hand Guide command of the Task Writer, the button can be used even in Auto mode.

4.2.2 Cockpit Button (five buttons)

The user can change the robot's pose while holding down the Hand-guiding button or custom button on the cockpit.

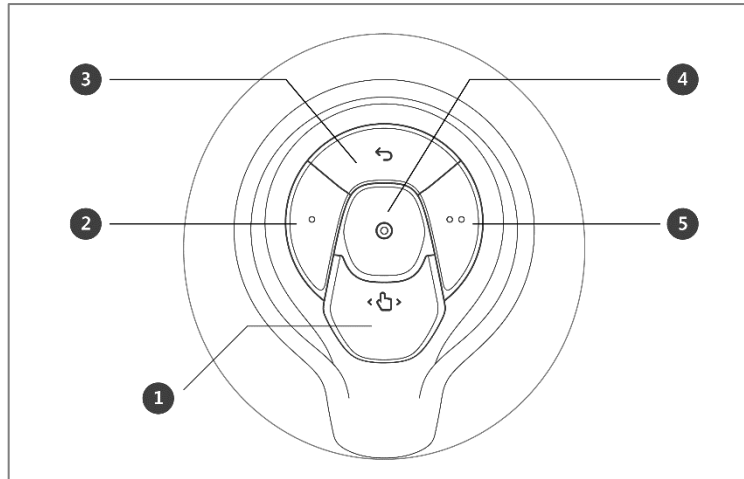

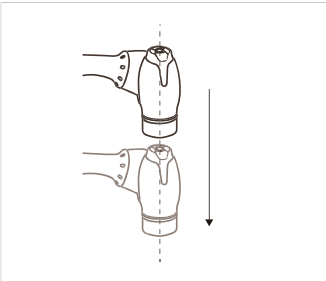
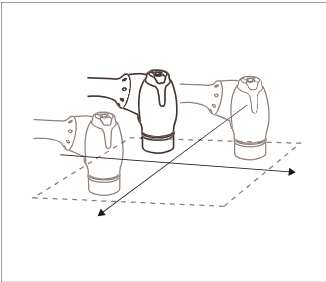
No.	Item	Description
1	Hand-Guiding Button	This button can be used to adjust or change the robot's pose.
2,5	User Setting Button	<p>This button can modify the robot's pose by entering a pose according to a lock condition corresponding to a mode.</p> <ul style="list-style-type: none"> • Axis Lock: Changes the pose according to the Z-axis of the tool coordinates  <ul style="list-style-type: none"> • Surface Lock: Changes the pose according to the X-Y surface of the tool coordinates 

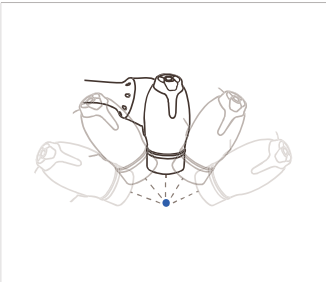
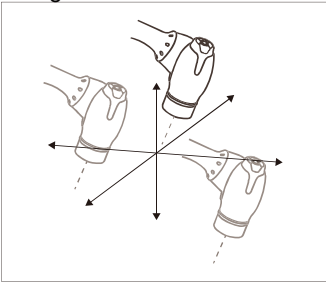
No.	Item	Description
		<ul style="list-style-type: none"> • Point Lock: Changes the angle only from the reference point of the tool coordinates  <ul style="list-style-type: none"> • Angle Lock: Changes the position only with the current TCP angle locked  <p>For more information about the settings, refer to “12.3.2 Cockpit Setting.”</p>
3	Cancel Button	Deletes the most recently saved pose.
4	Save Pose Button	Saves the current robot pose. For more information, refer to “ 8.7.3 Skill Command Work Point Setting with Cockpit Buttons. ”

4.2.3 Cockpit Button (six buttons)

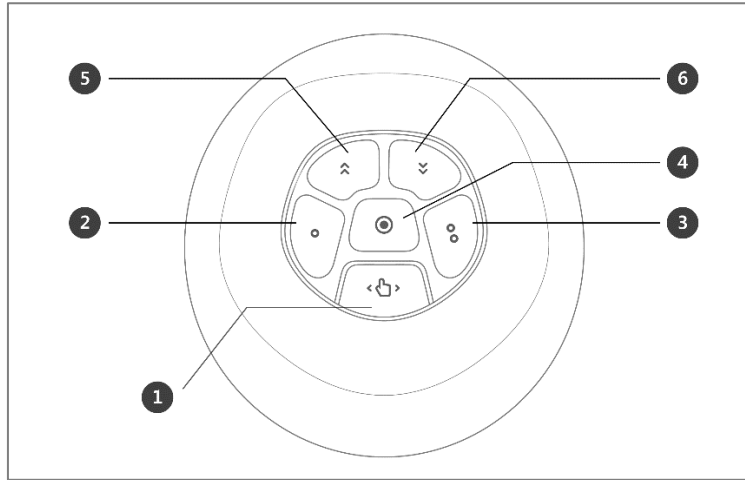

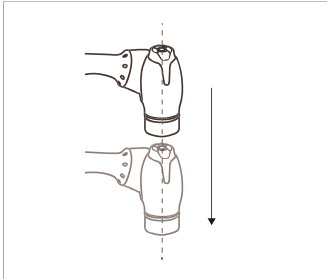
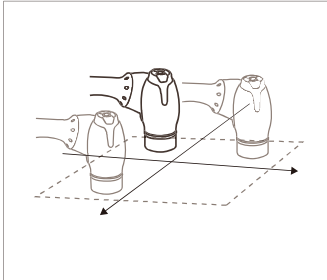
No.	Item	Description
1	Hand-Guiding Button	This button can be used to adjust or change the robot's pose.
2,3	User Setting Button	<p>This button can modify the robot's pose by entering a pose according to a lock condition corresponding to a mode.</p> <ul style="list-style-type: none"> • Axis Lock: Changes the pose according to the Z-axis of the tool coordinates  <ul style="list-style-type: none"> • Surface Lock: Changes the pose according to the X-Y surface of the tool coordinates  <ul style="list-style-type: none"> • Point Lock: Changes the angle only from the reference point of

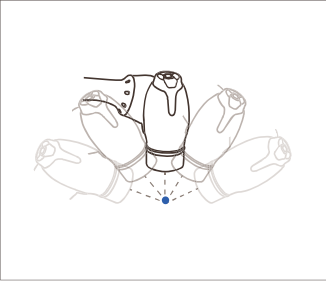
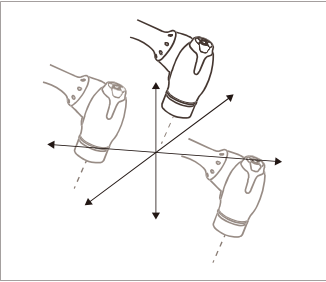
No.	Item	Description
		<p>the tool coordinates</p>  <ul style="list-style-type: none"> • Angle Lock: Changes the position only with the current TCP angle locked  <p>For more information about the settings, refer to “12.3.2 Cockpit Setting.”</p>
4	Save Pose Button	Saves the current robot pose. For more information, refer to “ 8.7.3 Skill Command Work Point Setting with Cockpit Buttons. ”
5	One Line Up	Moves the Focus displayed on the screen one line up
6	One Line Down	Moves the Focus displayed on the screen one line down

Note – Cockpit Setting Change

- **1** The hand-guiding button **2** and **3** constraints motion button settings require 0.2 seconds to be modified.
- Pressing the Save Pose button on the Skill Setting screen will automatically move the focus to the next pose.
- The cancel button can only be used in the Skill Setting window that manages multi-poses.

Version A Series

- As the constraints motion of the A-Series uses FTS on the end, it must be moved with the tool attached while holding the tool. (Moving it while holding the body may not trigger a reaction.)

4.2.4 Exit Cockpit

If the Exit Cockpit function is activated from “12.3.2 Cockpit Setting”

exit the cockpit by using the ② button and ⑤ button for 5-button systems, or the ② button and ③ button for 6-button systems to activate the function.

If the Exit Cockpit function is activated,

- Entering from Servo Off status -> Enters in Backdrive Handguiding Mode.

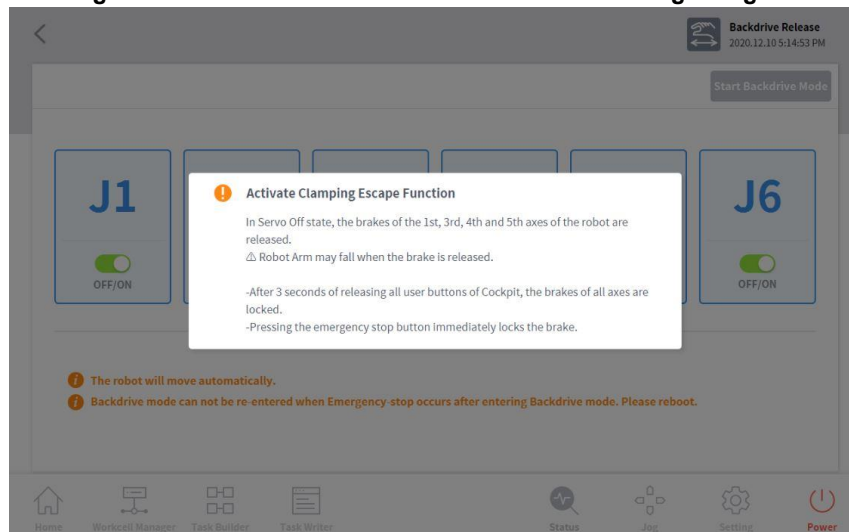

- Entering from Safety Stop status -> Enters in Recovery Handguiding Mode.

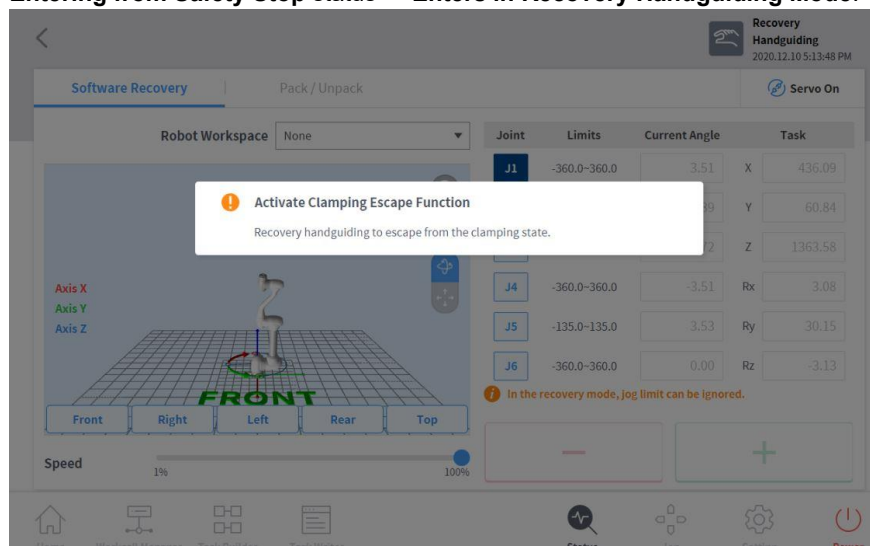

4.3 Robot Teaching and Execution

In order to use the robot in the user's process, the robot space, end effector, machine tools and peripherals must be configured in the **Workcell Manager** first. When **Workcell Manager** setting is complete, create a task program using **Task Builder** or **Task Writer**, and execute it.

Task Builder displays commands recommended for the peripherals registered using the Workcell Manager, which allows the user to easily create and execute task programs. It also offers a custom code function which can load and execute task programs which have been created based on the Programming Manual.

Task Writer uses DRL (Doosan Robot Language) to create and execute programs suited for the user's process, and it also features a Custom Code function where the user can load and execute task programs created by referring to the Programming Manual.

For more information about the **Workcell Manager**, refer to “**7 Workcell Manager**”; for more information about **Task Builder**, refer to “**8 Task Builder**”; and for details on **Task Writer**, refer to “**9 Task Writer**.” For more information about the Doosan Robot Language, see the separate **Programming Manual**.



Caution

Make sure to perform a risk assessment before teaching and operating the robot. Doosan Robotics is not responsible for any consequences due to operating the robot without proper risk assessment.

5. System Operation Program Outline

The UI of the system operation program consists of the following:

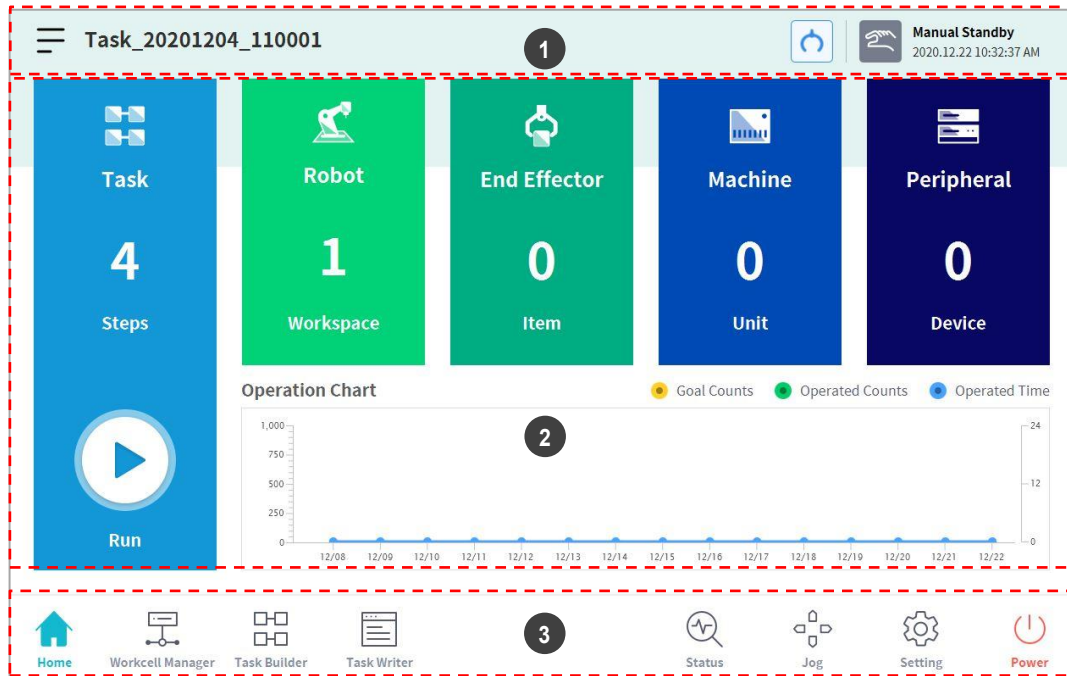

No.	Item	Description
1	Status Display Area	This area displays the name of the task currently being executed and the current work status.
2	Work Screen Area	This area is where the user enters and changes settings when performing work using the robot. This area is displayed differently according to the selected main menu.
3	Main Menu Area	This area is the main menu of the system, and pressing each menu will go to the corresponding screen.

5.1 Status Display Area

The status display area displays the current robot status and the opened task. The items displayed in the area may vary according to the screen displayed.



No.	Item	Description
1	Menu	Tap the Menu button to create a new task, or save or load a task currently being edited. The functions displayed when the menu button is tapped vary according to the screen displayed.
2	Task Name	The name of the task currently being executed is displayed.
3	Tool Setting Button	It runs the Tool Setting popup. refer to “6.3 Tool Setting”
4	Robot Status	The current work status and time of the robot are displayed.

Note – Robot Work Status List



Check the robot status shown in the status display area. The information can be used as a reference when performing work using the robot.

- **Standby:** In this status, the robot can be operated, robot settings can be changed or motions can be tested.
- **In Operation:** In this status, the robot is operating, and robot settings cannot be changed.
- **Safety Off:** The power to the motor and brake are cut off, and the robot has stopped.
- **Safety Stop:** The robot has stopped due to an error or safety issue, so stop the current work and check the robot.
- **Emergency Stop:** the robot has stopped due to the activation of the emergency stop button.

5.2 Work Screen Area

The screens displayed on the work screen vary according to the main menu selected by the user.

Note – Status, Jog, Setting Popup Window

The **Status**, **Jog** and **Settings** screens are displayed in popup windows for operation convenience, and tapping the  button in the popup window will return to the edit screen prior to the popup window. Pressing the **Workcell Manager**, **Task Builder** or **Task Writer** button on the main menu without closing the popup window using the  button on the **Status**, **Jog** or **Settings** screen will enter a new screen rather than returning to the previous screen.

5.3 Main Menu

Major functions of the system can be checked in the main menu. Tap each menu button to go to the corresponding menu screen.



- **Home:** It is the initial screen of the system, and information and a work progress graph of the current task are displayed. For more information about home, refer to “**6 Home Screen Overview.**”
- **Workcell Manager:** Robots and peripherals can be added to the task and managed. For more information about the Workcell Manager, refer to “**7 Workcell Manager.**”
- **Task Builder:** Commands provided by the system can be added or deleted to configure a single task. For more information about Task Builder, refer to “**8 Task Builder.**”
- **Task Writer:** Advanced users can configure a single task by adding, editing or deleting commands to be used in the task. For more information about the Task Writer, refer to “**9 Task Writer.**”
- **Status:** The I/O status of devices connected to the robot and controller can be checked. For more information about the status, refer to “**9.6 Debug Screen.**”
- **Jog:** The robot can be moved to or aligned with a specific point using the jog button. For more information about jog, refer to “**11 Jog Function.**”
- **Setting:** System-related settings, such as language, password and network, can be configured. For more information about setting, refer to “**12 Environment Setting.**”
- **Power:** Power to the system can be turned off.

Note – Disabling Main Menu Button

When the robot is in Servo Off or in Auto mode, some of the main menu becomes disabled, limiting user operation.

- **Servo Off:** In Servo Off, main menu buttons other than **Home**, **Status**, **Settings** and **Power** are disabled. To change from Servo Off to Servo On, tap the **Status** button on the main menu and tap the **Servo On** button on the **Status** screen. When the robot is in Servo On, **Workcell Manager**, **Task Builder**, **Task Writer** and **Jog** buttons are enabled.
- **Auto Mode:** This is the mode where the robot is operated automatically according to the user’s task. Main menu buttons other than the **Status** and **Power** buttons are disabled. Stopping the current task will enable all buttons.

Screen Information not updated when transferring control from certain screens

- When transferring control between Windows and Teach Pendant from the same screen, the information saved on one screen is not automatically reflected in the other device until reloading is performed.

6. Home Screen Overview

Information about the current task status and task, and work progress graphs are displayed.

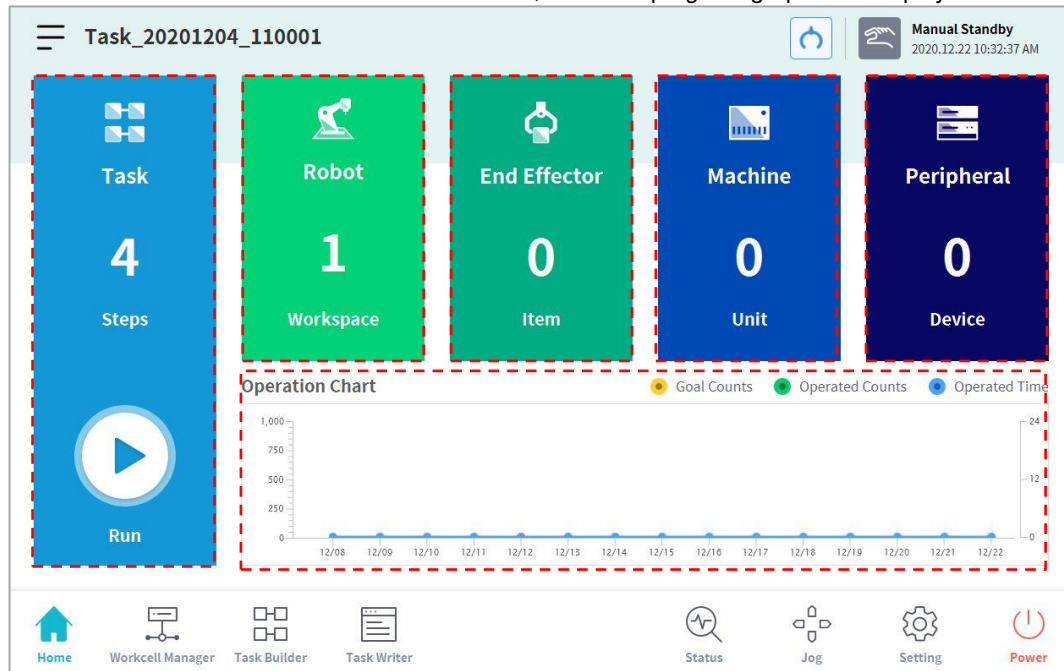



Item	Description
Task	<p>The total number of lines of the task program is displayed.</p> <p>Tapping the number indicating the program line will go to Task Builder or Task Writer.</p> <p> Tapping the Execute button will go to a screen showing the opened task. For more information about the task execution screen, refer to “6.1 Task Execution and Stopping”.</p>
Robot	<p>Displays the number of settings of the robot work space. Tap this item to go to the robot item setting screen of the Workcell Manager. For more information about the robot, refer to “7.5 Robot Setting”.</p>
End Effector	<p>Displays the number of end effectors connected to the robot. Tap this item to go to the end effector setting screen of Workcell Manager. For more information about end effectors, refer to “7.6 End Effector Setting”.</p>
Machine	<p>Displays the number of machines used in the task. Tap this item to go to the machine setting screen of Workcell Manager. For more information about the robot, refer to “0 Machine Tool Setting”.</p>

Item	Description
Peripherals	Displays the number of peripherals connected to the task. Tap this item to go to the peripheral setting screen of Workcell Manager. For more information about peripherals, refer to “ 7.8 Peripheral Setting ”.
Work Status	Displays the target number , work count , and time of the current task. The information displayed can be selected using checkboxes.

6.1 Task Execution and Stopping

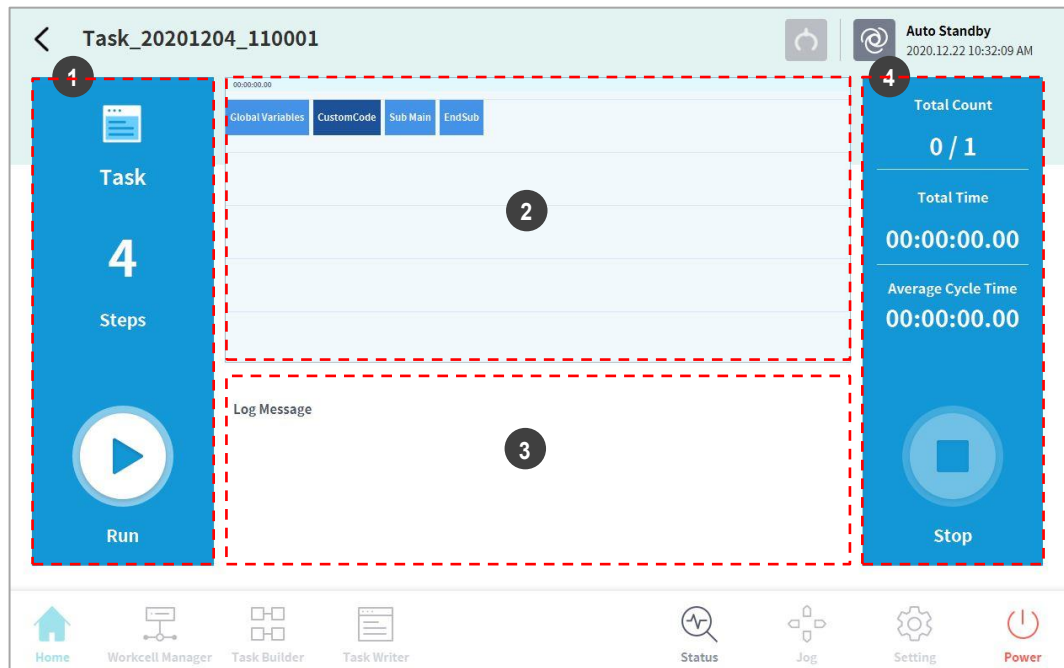
Tap the **Execute** button on the **Home** screen to view, execute or stop tasks.



No.	Item	Description
1	Start/Pause Task	The total number of lines of the task program is displayed. Tap the  Execute button to execute or pause the task.
2	Task Information Check	The command the robot is executing repeatedly can be checked.
3	Log Message	Displays log information of the task.
4	Task Execution Information and Stop	Displays task repetition count, play time and average one cycle execution time. Tap the Stop button to stop the current task.

6.2 Load Saved Tasks

Tasks saved on the system can be loaded from the **Home** screen.

- 1 Tap the  menu button on the top left of the Home screen.
- 2 Tap **Open**.
 - A list of tasks saved on the system is displayed on the screen right.
- 3 Tap the task to execute from the list.
 - Moves to the screen to check and execute tasks.

Note

- At first start-up of the system, the list is empty.

6.3 Tool Setting

It sets the tool center point, weight and shape, which act as the basis for robot movement. It is possible to set and enable multiple end effectors and the tool center point, weight and shape on the Workcell Manager screen, so the tool center point, weight and shape of the end effector to be used must be set in **Tool Settings** of the tool.

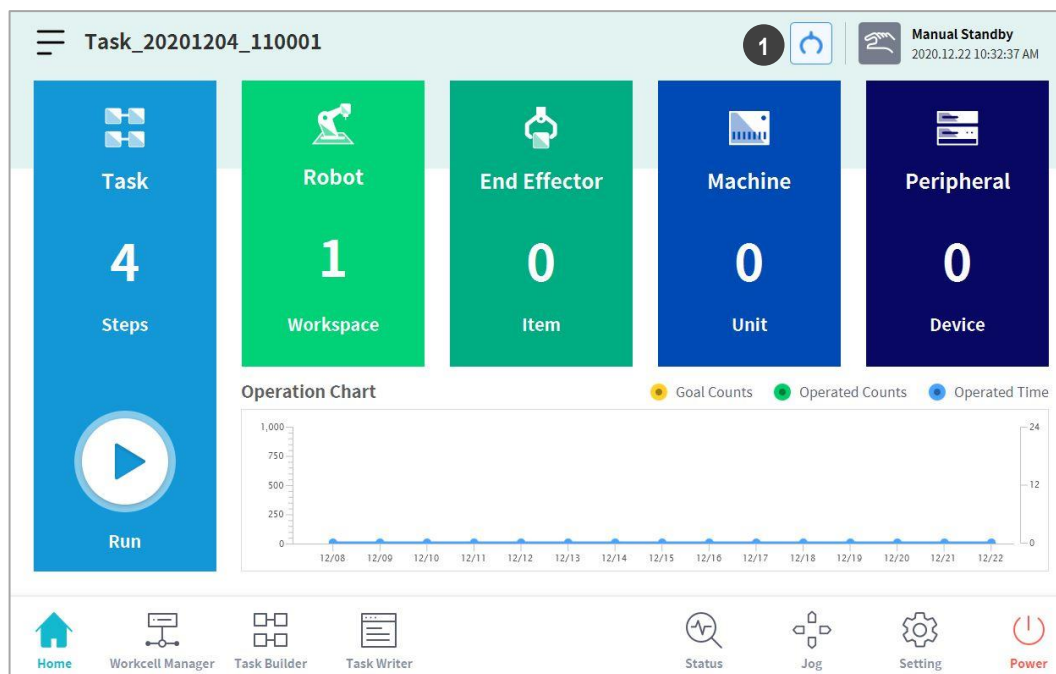

No.	Item	Description
1	Tool Setting Button	It runs the Tool Setting popup.

1 Select the **Tool Setting** button.

2 Select the desired Workcell item from the **Tool Center Point, Weight** or **Tool Shape**.

Tool Setting Manual Standby 2020.12.22 10:33:28 AM

Tool Center Position

Item: Select [Set] [Reset]

Position					
X	0.000 mm	Y	0.000 mm	Z	0.000 mm
A	0.00°	B	0.00°	C	0.00°

Tool Weight

Item: Select [Set] [Reset]

Weight: 0.000 kg Cx: 0.000 mm Cy: 0.000 mm Cz: 0.000 mm

Tool Shape

Item: Select [Set] [Reset]

Home Workcell Manager Task Builder Task Writer Status Jog Setting Power

3 Press the **Setting** button to save the tool center point, weight or shape of the corresponding Workcell item.

Note

- The robot's tool center point and tool weight can be set to default where no input is made by pressing the **Reset** button.

7. Workcell Manager

7.1 What is a Workcell Item?

Workcell Item refers to the robot and all peripherals used together with the robot.







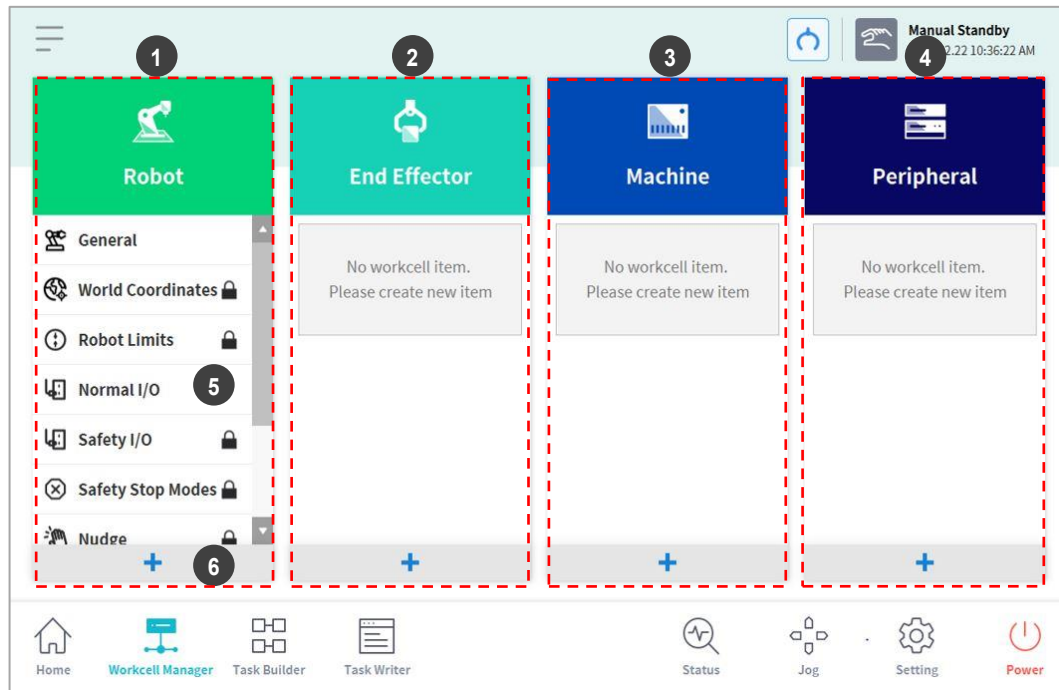











Workcell items can be configured in the Workcell Manager screen before use. Also, the *Workcell Manager* can set commands for peripherals and can configure commands for the robot to perform certain patterns and actions.

The combination of skills available change according to the configured Workcell Items, and in certain conditions, Task Builder can recommend a suitable task template.

The following screen appears when the **Workcell Manager** in the main menu is tapped.



No.	Item	Description
1	Robot	<p>Setting items related to the robot can be added, and added setting items are displayed.</p> <ul style="list-style-type: none"> • General • World Coordinates • Robot installation pose • Tool weight • Tool shape • Work Space • Collaborative work space

No.	Item	Description
		<ul style="list-style-type: none"> • Protection section • Disable collision detection section • Tool direction change limit section
2	End Effector	<p>End effectors can be added to the robot, and the added end effector is displayed.</p> <ul style="list-style-type: none"> •  Pneumatic gripper •  Vacuum gripper •  Screwdriver •  Gluing tool •  Deburring tool •  Air blow nozzle •  Polishing tool •  Custom Tool
3	Machine	<p>Machines compatible with the robot can be added, and the added machine is displayed.</p> <ul style="list-style-type: none"> •  Press machine •  Turning center •  Injection molding machine
4	Peripherals	<p>Peripherals connected to the robot can be added, and the added peripheral is displayed.</p> <ul style="list-style-type: none"> •  Pallet Pattern •  Air blower •  Conveyor •  Stocker •  Shooting bolt feeder •  Laser scanner •  Bolt feeder
5	Workcell Item Area	<p>List of Workcell items registered in each category is displayed. Selecting a Workcell item moves to the corresponding Workcell item setting screen.</p>
6	Add Workcell Item Button	<p>Adds a Workcell item to each category. Tap the add Workcell item button at the bottom of the category to go to the Workcell item select screen of the corresponding category.</p>

 **Note**

- Detailed explanations of various Workcell items provided by the Workcell Manager are provided in a reference manual.

7.2 Add Workcell Item

Tap the **+** add button at the bottom of each Workcell displayed on the initial screen of the Workcell Manager to display the Workcell category and type selection screen. Select the Workcell category and type to register, and tap the **Select** button to go to the corresponding Workcell setting screen.

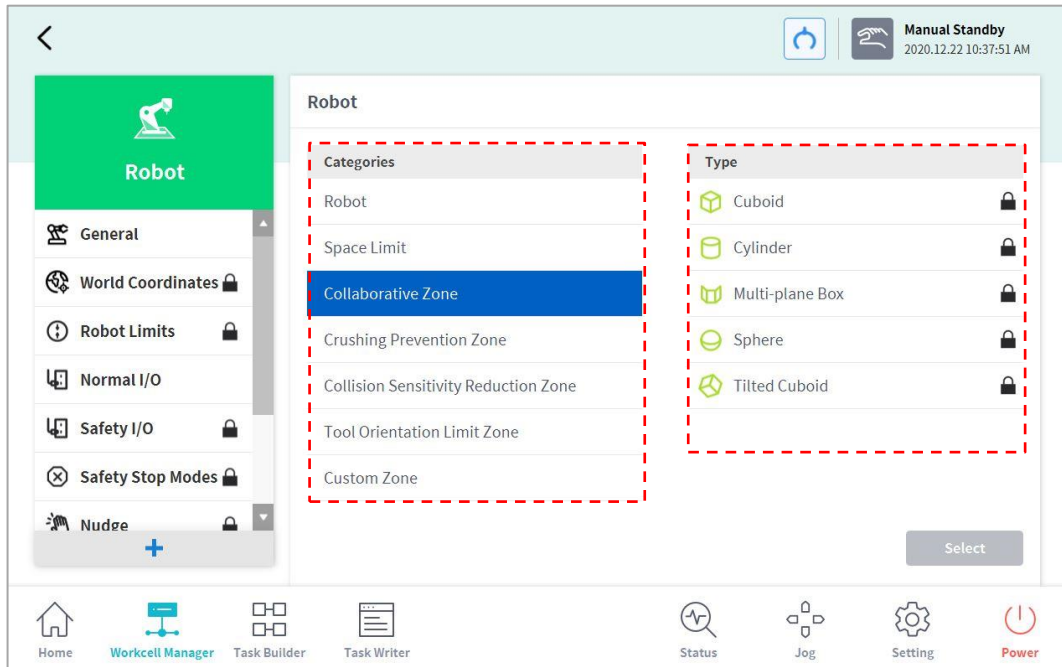

7.3 Deprecated Workcell Item

Workcell items are managed in two states: Normal, where new items can be registered, and Deprecated, where maintenance is no longer possible.

Workcell Items can be updated due to increased usability and additional motion improvements. If a Workcell Item is updated, the existing Workcell Item becomes deprecated, and it cannot be added or edited. Deprecated Workcell Items are displayed as gray icons.

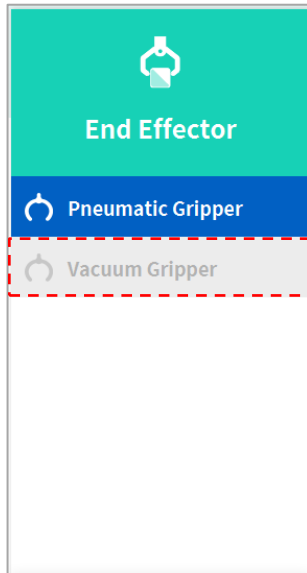

Deprecated Workcell Items cannot be added, but they can be used to view setting information and can also be used in the current task program.

If a deprecated Workcell Item is selected, the setting information of the Workcell Item is displayed along with a message stating “**Deprecated Item.**”

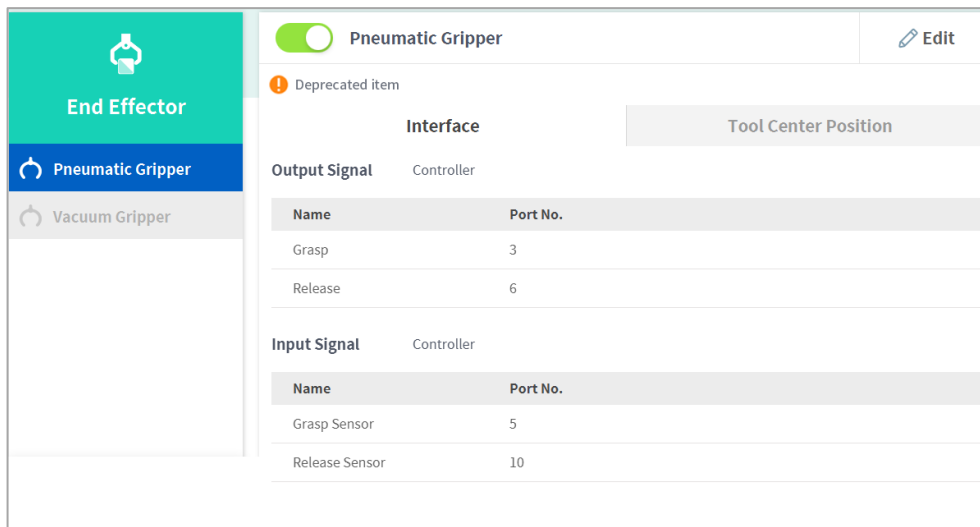

Deprecated item

Interface Tool Center Position

Output Signal Controller

Name	Port No.
Grasp	3
Release	6

Input Signal Controller

Name	Port No.
Grasp Sensor	5
Release Sensor	10

Tapping the **Edit** button cannot edit the setting, but deletion is possible.

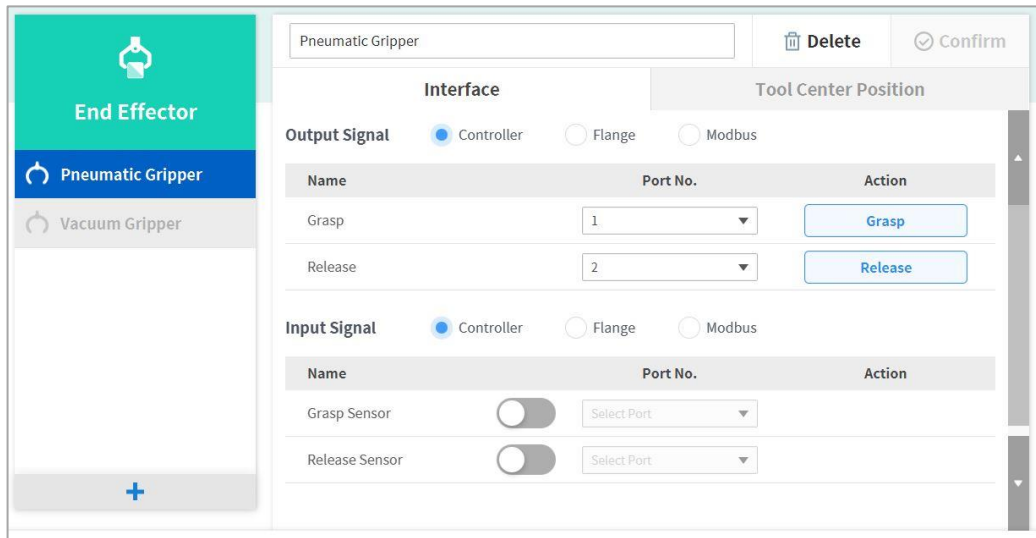

7.4 Unavailable Workcell Items

Any 3rd Party Workcell Item which is not installed or do not have a compatible version will be listed as an Unavailable Workcell Item.

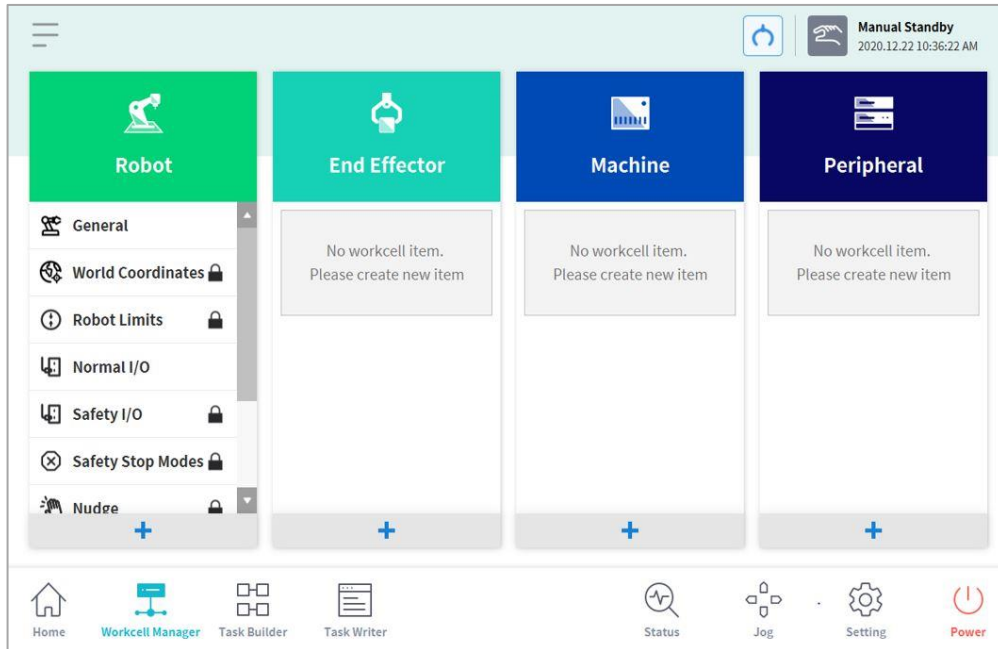

This displays the Workcell Item Package Version compatible with the current SW, Workcell Items that are not installed, and the name and type of Workcell Items that are not compatible. In order to properly use such Workcell Items, the corresponding Workcell Item must be downloaded from Doosan Mate and installed.

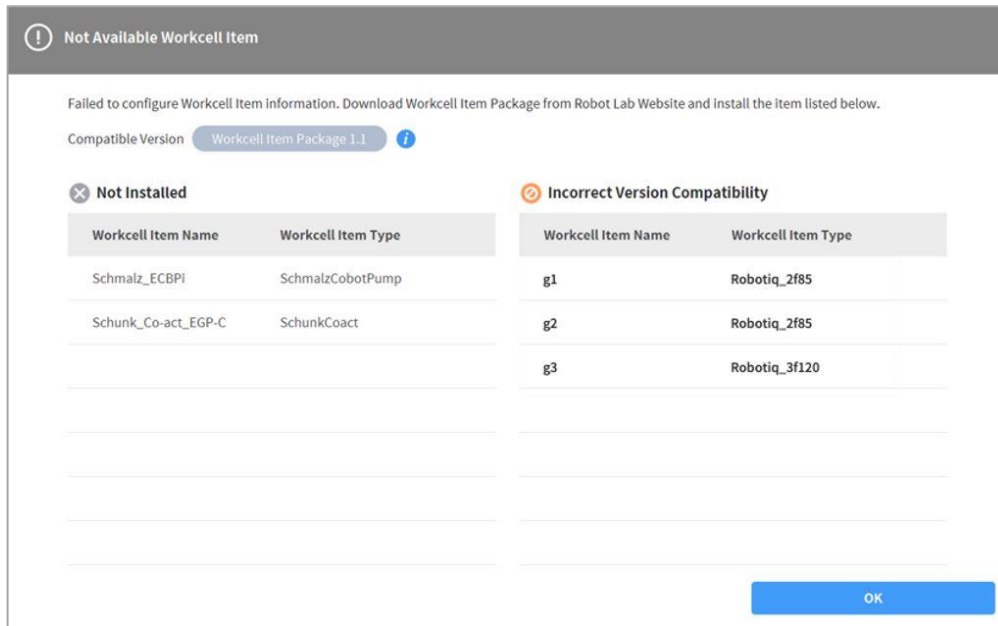

7.5 Robot Setting

The robot setting screen layout is composed as follows:

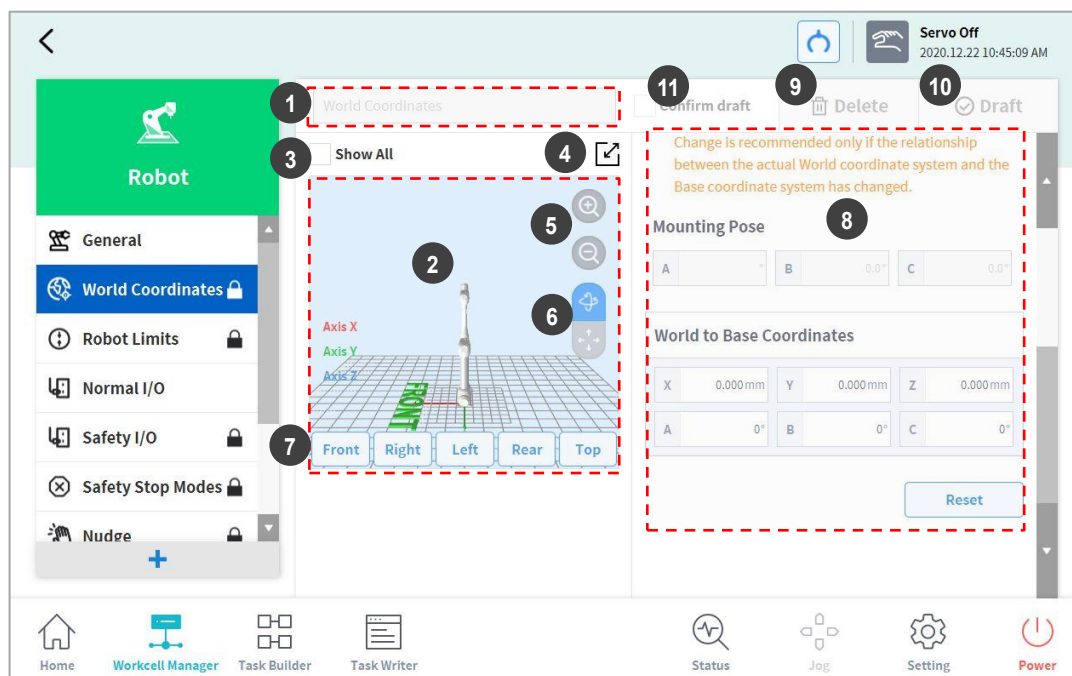

No.	Item	Description
1	Enter Workcell Name	Enter the name of the Workcell.
2	Simulation Screen	Displays the work space simulation of the Workcell.
3	View All	All other registered Workcells are displayed. Selecting all checkboxes enables the View All function. De-selecting checkboxes disables the function.
4	Change to Full Screen (☒)	The simulation screen is displayed as a full screen. Tap the minimize button (☒) on the full screen to return to the minimized screen.
5	Zoom In (⊕)/Zoom Out (⊖)	Zoom in or out the simulation screen.
6	Rotate (🔄)/Move (📏)	Rotate or move the simulation screen. Tap the button and drag or tap the screen to control.
7	Simulator Direction Setting	Sets the direction of the simulator. The simulation is displayed from the selected direction.
8	Workspace	Displays the workspace of the Workcell.

No.	Item	Description
9	Delete	Deletes the current Workcell.
10	Draft Confirm	Draft: This temporarily saves the workspace settings of Workcell. Confirm: This saves the current or confirmed temporary save of the workspace settings of Workcell. (For safety-related Workcells only, the Confirm button is displayed after Confirm Temporary Save has been performed. For general Workcells, only the Confirm button is displayed.)
11	Confirm Draft	This confirms to save the temporarily saved workspace settings. (This is displayed only for safety-related Workcells and not displayed for general Workcells)

7.5.1 World Coordinates Setting

A coordinate system representing the robot and workpiece can be set. This coordinate system is called World Coordinates, and it is different from Base Coordinates, which are fixed to the base. It is possible to set the pose of Base Coordinates using World Coordinates, and World Coordinates can be selected when teaching and moving using the robot in Task Builder and Task Writer. To set World Coordinates, tap the **+** Add button on the **Robot** Workcell and select **Robot > World Coordinates**.

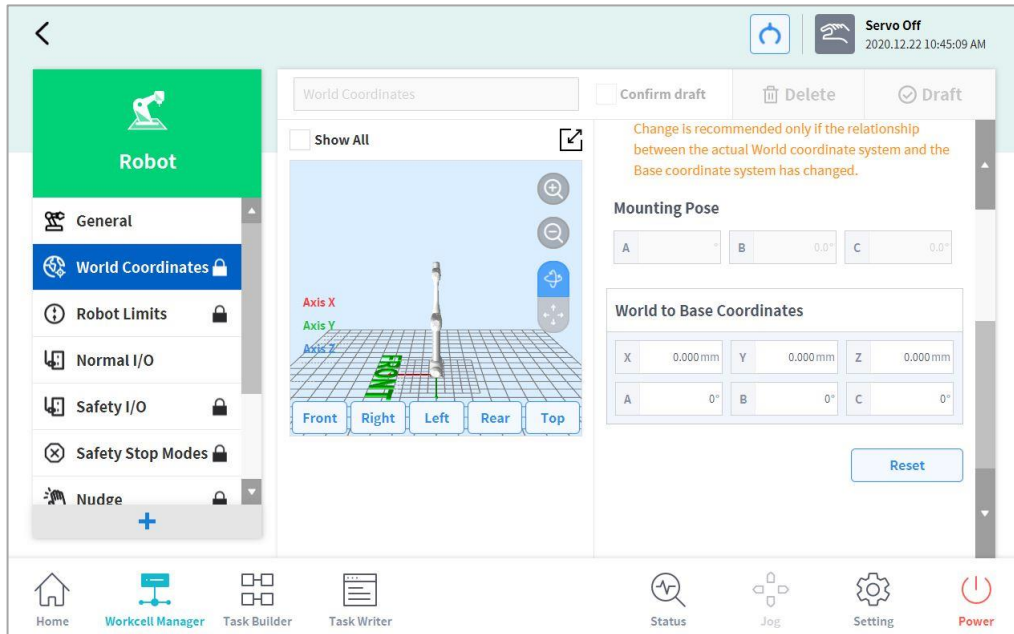

1 Tap the Edit button at the top.

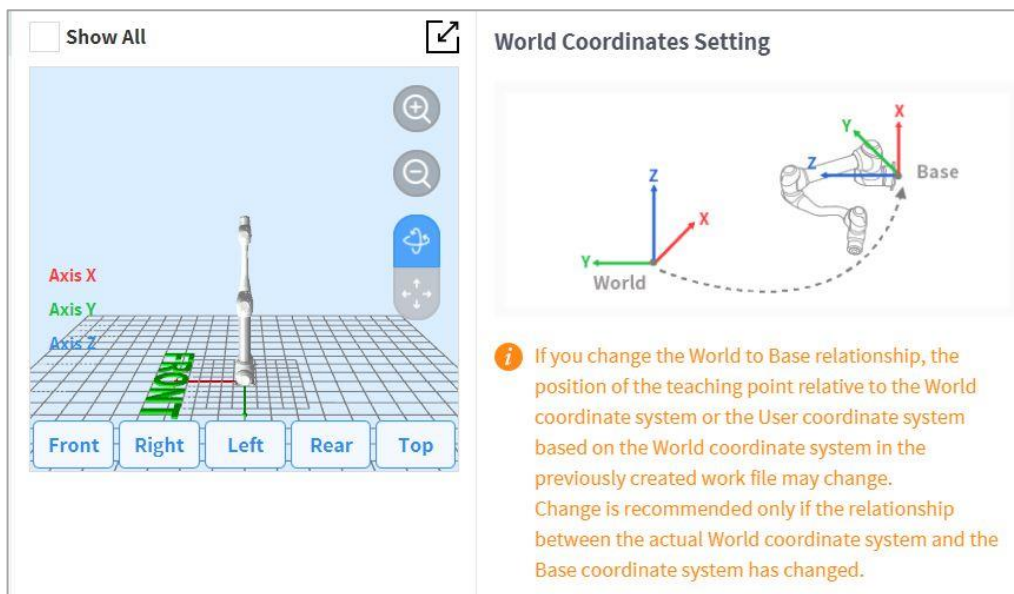

- 2 Please refer to the figure depicting the relationship between the World Coordinate and Base Coordinate, as well as related precautions.

 **Warning**

- When changing the relationship between World and Base coordinates, the teaching point of World Coordinates or user coordinates based on World Coordinates can change. Changes are only recommended when the actual relationship between World Coordinates and Base Coordinates are changed.

- 3 The mounting pose (installation inclination) is displayed on the right center. In general, World Coordinates describe the work environment from the user's perspective, so the Z-direction of World Coordinates is in the direction of the ceiling. Since one axis of Base Coordinates is fixed to the bottom plane of the robot, the relationship between World Coordinates and Base Coordinates changes according to the robot's installation location/pose. The above figure assumes that the robot is installed on a wall. In this case, the Z-axis of Base Coordinates is perpendicular to the wall, which is in parallel to the Y-axis of World Coordinates, and the mounting pose inclination and rotation are displayed as 90 and 0 degrees, respectively. The relationship between World and Base Coordinates is defined as the relationship of the Base Coordinates based on World Coordinates. If there is a predefined layout for the work environment, set the coordinates accordingly. The values X/Y/Z mean movement, and the values A/B/C mean rotation based on the definition of Euler Z-Y-Z. If the mounting pose is defined according to the robot's installation pose, it is appropriate to use the rotation angle of B/C as the mounting pose B/C. However, if the mounting pose is set using the Auto assumption function, the assumed value may contain a deviation, so it recommended to use the rotation angle defined according to the layout.

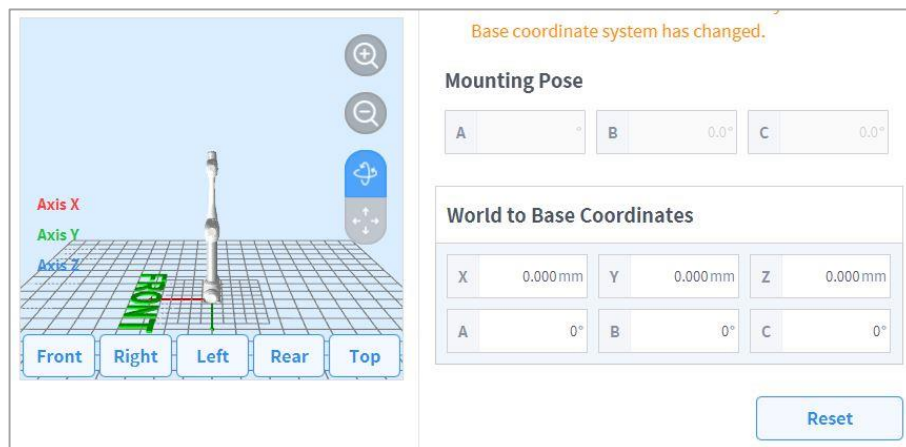

- 4 Tap the **Apply** button.
- 5 Tap the **Confirm** button.

 **Note**

- User programs created using Task Builder and Task Writer after applying the installation inclination in SW versions earlier than GF020400 must set World Coordinates with the installation inclination applied when updating to SW versions later than GF020400 and convert

all Base Coordinates into World Coordinates within the user program in order to properly use existing teaching points.

If multiple robots are working in a common work space or if the robot is installed on a moving device such as a mobile base or linear track, the relationship and teaching point position between the workpiece and robot base may change. In such environments, World Coordinates, which are easy to teach work and share, can be set. For more information, refer to “**7.5.1 World Coordinates Setting**”.

When a tool is installed or replaced, the weight of the tool must be configured before operating the robot. For more information about setting tool weight, refer to “**7.5.8 Tool Weight Setting**”.

7.5.2 Robot Limits Setting

It sets the safety limits of safety monitoring functions.

Note

- The limit and initial safety settings may vary according to the robot lineup.
- Safety limits is the condition where the safety-rated monitoring function triggers the stop function. When stop is completed, the position of the robot and force applied externally may differ from the configured safety threshold.

• TCP/Robot Limits

To set the TCP/Robot Limits, go to the **Robot Workcell** and select **Robot > Robot Limits > TCP/Robot**. The TCP/Robot Limits setting screen layout is composed as follows:

Category	Limits	Normal mode	Reduced Mode
1 Force	550.00 N	144.00	72.00
2 Power	1600.00 W	600.00	100.00
3 Speed	8000.000 mm/s	2000.000	1500.000
4 Momentum	165.00 kg.m/s	82.00	50.00
5 Collision	100.00 %	75	

No.	Item	Description
1	Force (N)	It can limit the force level applied to the tool center point (TCP).
2	Power (W)	It can limit the mechanical power level of the robot.
3	Speed (mm/s)	It can limit the speed of the tool center point (TCP).
4	Momentum (kg.m/s)	It can limit the momentum size of the robot.

No.	Item	Description
5	Collision (%)	It configures the collision detection sensitivity.
6	Default Value	It resets the TCP/Robot Limits settings to default values.

• Joint Speed Limits

To set the joint speed limits, go to the **Robot** Workcell and select **Robot > Robot Limits > Joint Speed**. The Joint Speed Limits setting screen layout is composed as follows:

Joint	Limits	Normal mode	Reduced Mode	Tolerance
J1	120.0 %/s	120	120	10.0 °/s
J2	120.0 %/s	120	120	10.0 °/s
J3	180.0 %/s	180	180	10.0 °/s
J4	225.0 %/s	225	225	10.0 °/s
J5	225.0 %/s	225	225	10.0 °/s
J6	225.0 %/s	225	225	10.0 °/s

No.	Item	Description
1	Joint Speed	It can limit the speed of each joint.
2	Default Value	It resets the Joint Speed Limits settings to default values.

- **Joint Angle Limits**

To set the joint angle limits, go to the **Robot** Workcell and select **Robot > Robot Limits > Joint Angle**. The Joint Angle Limits setting screen layout is composed as follows:

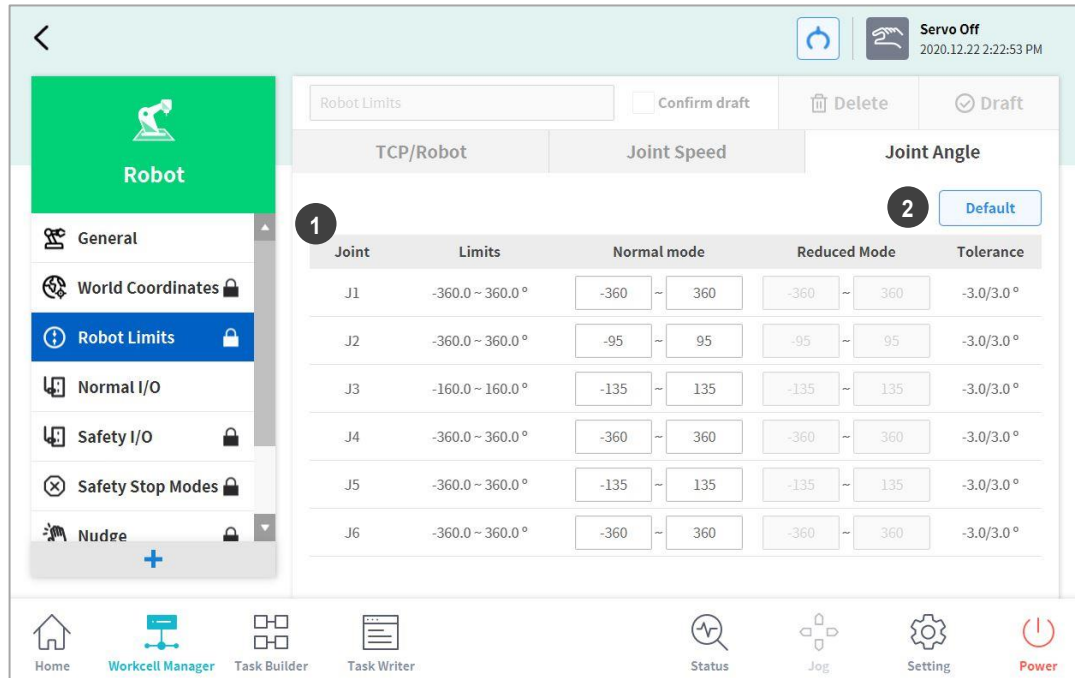

No.	Item	Description
1	Angle Range of each Joint	It can limit the angle range of each joint.
2	Default Value	It resets the Joint Angle Limits settings to default values.

7.5.3 Safety I/O Setting

This function inputs/outputs safety-related signals through a redundant terminal. If a signal that is different from the redundant safety input or output signal is detected, the system determines whether it is a short circuit or hardware defect and stops the robot with STO Stop Mode. To set the Safety I/O, go to the **Robot Workcell** and select **Robot > Safety I/O**.

- **Safety Input Setting**

Safe Torque Off (L)	<ul style="list-style-type: none"> • High: Normal operation • Low: Immediately cuts the motor power and engages the brakes to force the robot to stop.
Emergency Stop (L)	<p>It is an interface to receive emergency stop signal from peripheral device, or connect additional emergency stop switches.</p> <ul style="list-style-type: none"> • High: Normal operation • Low: It stops the robot according to the Stop Mode of the Emergency Stop of the Safety Stop Mode.
Protective Stop (L)	<p>It can be linked with Safeguarding Devices such as safety matts, light curtains and laser scanners.</p> <ul style="list-style-type: none"> • High: Normal operation • Low: It stops the robot according to the Stop Mode of the Protective Stop of the Safety Stop Mode.
Reduced Speed (L)	<ul style="list-style-type: none"> • High: Operates the robot at the normal speed set in the task • Low: It operates the robot at a speed proportionately reduced from the speed set in the task. The reduction ratio can be adjusted using the Speed Reduction Ratio slide bar. If a signal is detected within a collaborative workspace, the robot is operated at the smaller speed reduction ratio (slower) between the main speed reduction ratio and the collaborative workspace speed reduction ratio.
3 Pos Enable Switch (H)	<p>This is operation permission equipment that is used to connect a three-point switch.</p> <ul style="list-style-type: none"> • High: Jog and servo On available in Manual Mode Can Play at Stop/Resume status in Auto Mode • Low: Cannot start jog in Manual Mode, and if jog is operating, cannot stop and Servo On
Handguiding Enable Switch (H)	<p>It is an operation permission equipment used to connect a hand guide switch.</p> <ul style="list-style-type: none"> • High: Hand-guiding available • Low: Hand-guiding unavailable
HGC End & Resume (Rising Edge)	<p>Used to resume task program execution after a task program is stopped by the handguiding command during Auto Mode and the operator executed handguiding control.</p> <ul style="list-style-type: none"> • Low to High: Resumes task program after a handguiding command

Protective Stop (Auto Reset and Resume) (L & Rising Edge)	<p>Unlike Protective Stop, if the safeguarding device signal is cancelled, robot operation resumes automatically.</p> <p>This can be used to auto resume robot operation after the Safety-rated Monitored Stop signal is cancelled as described in ISO TS 15066.</p> <ul style="list-style-type: none"> • Low to High: If the robot stops due to a Protective Stop (Auto Reset & Resume) signal, the task resumes automatically without the program needing to be restarted from the Teach Pendant. • Low: This stops the robot according to the stopping method selected for Protective Stop under the Safety Stop Mode.
--	--



Warning

As automatically resuming robot operation can be dangerous, make sure to conduct a risk assessment to confirm that operation is safe before resuming.

Safety Zone Dynamic Enable (H)	<p>It is available when dynamically activating the temporary disable safety section.</p> <ul style="list-style-type: none"> • High: If safety input is registered during temporary disable safety section setting, it activates the temporary disable safety section. • Low: If safety input is registered during temporary disable safety section setting, it deactivates the temporary disable safety section.
Remote Control Enable (H)	<p>Used to enable the Remote Control Mode.</p> <ul style="list-style-type: none"> • High: Remote Control Mode enabled. • Low: Remote Control Mode disabled.
Remote Emergency Stop(L)	<p>Sets the port for emergency stop at Remote Control Mode.</p> <ul style="list-style-type: none"> • High: Normal operation • Low: It stops the robot according to the Stop Mode of the Emergency Stop of the Safety Stop Mode.

**Reset and Resume
(Rising Edge)**

This is used to resume the Task Program and shift the status to Normal, when the robot is stopped by a protective stop due to exceeding the safety threshold or due to the safety I/O signal input once the cause of the occurrence has been removed.

- **Low to High:** This resumes the stopped Task Program



Warning

This can be dangerous as a single signal executes both reset and resume. Before executing this signal, conduct a risk assessment to confirm that the operation is safe.

• **Safety Output Setting**

Safe Torque Off (L)	<ul style="list-style-type: none"> • High: Robot is not in STO state • Low: Robot is in STO state
Safe Operating Stop (L)	<ul style="list-style-type: none"> • High: Robot is not in SOS state • Low: Robot is in SOS state
SS1_2 Deceleration Status	<ul style="list-style-type: none"> • High: Normal operation • Low: Safety stop situation occurred
Normal Speed (L)	<ul style="list-style-type: none"> • High: Deceleration in operation • Low: Robot is operating at the speed set by the task program
Reduced Speed (L)	<ul style="list-style-type: none"> • High: Robot operating at normal speed • Low: The robot is located outside the collaborative workspace or is operating at reduced speed due to external deceleration mode signal input
Auto Mode (L)	<ul style="list-style-type: none"> • High: The robot is currently not in Auto Mode • Low: The robot is currently in Auto Mode
Manual Mode (L)	<ul style="list-style-type: none"> • High: The robot is currently not in Manual Mode • Low: The robot is currently in Manual Mode
Standalone Workspace (L)	<ul style="list-style-type: none"> • High: The robot's TCP is not in a standalone workspace • Low: The robot's TCP is in a standalone workspace
Collaborative Workspace (L)	<ul style="list-style-type: none"> • High: The robot's TCP is not in a collaborative workspace • Low: The robot's TCP is in a collaborative workspace
TCP Collision Detection Mute Zone (L)	<ul style="list-style-type: none"> • High: The robot's TCP is not in a designated collision detection section • Low: The robot's TCP is in a designated collision detection section
TCP Tool Orientation Limited Zone (L)	<ul style="list-style-type: none"> • High: The robot's TCP is not in a tool direction maintenance monitoring section • Low: The robot's TCP is in a tool direction maintenance monitoring section

Remote Emergency Stop(L)	<p>It is used to notify the user of a situation where emergency stop is required, such as when the Emergency Stop Button is pressed, external Emergency Button is pressed, or self-diagnosis defect is detected during Remote Control Mode.</p> <ul style="list-style-type: none"> • High: Normal operation • Low: Emergency stop required
Task Operating(L)	<ul style="list-style-type: none"> • High: Task is not in operation • Low: Task is in operation
Inside Zone Output(L)	<p>This is used to confirm if the TCP (Tool Center Point) is inside the user-defined Zone.</p> <p>The Inside Zone Output signal defined on the Safety Output setting screen can be selected from the Zone setting screen, and signals selected by a different Zone cannot be selected.</p> <ul style="list-style-type: none"> • High: If the TCP is not inside the Zone • Low: If the TCP is inside the Zone
Robot In Motion	<p>This is used to notify the operator that the robot joint is actually operating.</p> <ul style="list-style-type: none"> • High: The robot is stopped • Low: The robot is operating

7.5.4 Normal I/O Setting

This function outputs various robot status signals through a single terminal. To set the Normal I/O, go to the **Robot Workcell** and select **Robot>Normal I/O**.

- **Single Output Setting**

Safe Torque Off (L)	<ul style="list-style-type: none"> • High: The robot is not in STO status • Low: The robot is in STO status
Safe Operating Stop (L)	<ul style="list-style-type: none"> • High: The robot is not in SOS status • Low: The robot is in SOS status
SS1_2 Deceleration Status (L)	<ul style="list-style-type: none"> • High: Normal operation • Low: A safety stop situation occurred
Normal Speed (L)	<ul style="list-style-type: none"> • High: The robot is operating at reduced speed due to an external deceleration mode signal input • Low: The robot is operating at normal speed
Reduced Speed (L)	<ul style="list-style-type: none"> • High: The robot is operating at normal speed • Low: The robot is operating at reduced speed due to an external deceleration mode signal input
Auto Mode (L)	<ul style="list-style-type: none"> • High: The robot is not currently in Auto Mode • Low: The robot is currently in Auto Mode
Manual Mode (L)	<ul style="list-style-type: none"> • High: The robot is not currently in Manual Mode • Low: The robot is currently in Manual Mode
Standalone Zone (L)	<ul style="list-style-type: none"> • High: The robot's TCP is in one of the collaborative workspaces • Low: The robot's TCP is not in any of the collaborative workspaces
Collaborative Zone (L)	<ul style="list-style-type: none"> • High: The robot's TCP is not in any of the collaborative workspaces • Low: The robot's TCP is in one of the collaborative workspaces
High Priority Zone	<ul style="list-style-type: none"> • High: The robot's TCP is not in any of the collision sensitivity reduction zones • Low: The robot's TCP is in one of the collision sensitivity reduction zones
Tool Orientation Limit Zone (L)	<ul style="list-style-type: none"> • High: The robot's TCP is not in any of the tool orientation limit zones • Low: The robot's TCP is in one of the tool orientation limit zones
Task Operating (L)	<ul style="list-style-type: none"> • High: Task is not in operation • Low: Task is in operation
Designated Zone (L)	<p>This is used to confirm if the TCP (Tool Center Point) is inside the user-defined Zone.</p> <p>The Inside Zone Output signal defined on the Safety Output settings screen can be selected from the Zone settings screen, and signals selected by a different Zone cannot be selected.</p> <ul style="list-style-type: none"> • High: If the TCP is not inside the Zone • Low: If the TCP is inside the Zone

Robot In Motion	<p>This is used to notify the operator that the robot joint is actually operating.</p> <ul style="list-style-type: none"> • High: The robot is stopped • Low: The robot is operating
Remote Mode	<p>This is used to notify the operator that the robot is in remote mode.</p> <ul style="list-style-type: none"> • High: The robot is operating in remote mode • Low: The robot is not operating in remote mode
Mastering Alarm	<p>This is used to notify the operator that mastering is required due to an issue in the home position setting.</p> <ul style="list-style-type: none"> • High: The robot requires mastering • Low: The robot does not require mastering
Home Position	<p>This is used to confirm whether the robot is at the home position.</p> <ul style="list-style-type: none"> • High: The robot is at the home position • Low: The robot is not at the home position

7.5.5 Safety Stop Modes Setting

The safety-rated monitoring function can detect limit violations and set the stop mode used when stopping the robot. For more information about Stop Mode, refer to “2.3 Types of Stop Modes for Safety.” To set Safety Stop Modes, go to the **Robot** Workcell and select **Robot > Safety Stop Modes**.

- **Emergency Stop:** It sets the Stop Mode when the Emergency Stop button of the Teach Pendant or the additionally installed external device is activated. (Only STO or SS1 can be selected.)
- **Protective Stop:** It sets the Stop Mode when the externally connected protective equipment is activated.
- **Joint Angle Limit Violation:** It sets the Stop Mode when the angle of each joint exceeds the set limit range.
- **Joint Speed Limit Violation:** It sets the Stop Mode when the angle joint speed of each joint exceeds the set limit range.
- **Collision Detection:** It sets the Stop Mode when the external force applied to the axis exceeds the set limit range. Stop Mode for the collaborative workspace and standalone workspace can be set individually. In addition to STO, SS1 and SS2, RS1 can be set as the Stop Mode.
- **TCP/Robot Position Limit Violation:** The Stop Mode activated when the tool center point (TCP) and robot position violates the area set by **Robot** of the **Workcell Manager** can be set. It also determines whether the robot position is within the operation area, whether the robot violates the prohibited area, or whether the TCP is within the collaborative workspace/standalone workspace/designated collision detection section.
- **TCP Orientation Limit Violation:** It sets the Stop Mode when the direction of the tool center position (TCP) within the tool direction maintenance area exceeds the limit range set by the **Robot** of the **Workcell Manager**.
- **TCP Speed Limit Violation:** It sets the Stop Mode when the speed of the tool center point (TCP) exceeds the set limit range.
- **TCP Force Limit Violation:** It sets the Stop Mode when the external force applied to the tool center point (TCP) exceeds the set limit range. Stop Mode for the collaborative workspace and standalone workspace can be set individually. In addition to STO, SS1 and SS2, RS1 can be set as the Stop Mode.
- **Momentum Limit Violation:** It sets the Stop Mode when the robot momentum exceeds the set limit.
- **Mechanical Power Limit Violation:** It sets the Stop Mode when the mechanical power of the robot exceeds the set limit.

7.5.6 Robot Installation Pose Setting

The robot can be installed at any angle. To configure the robot installation pose, tap the **+** “Add” button on the **Robot** Workcell and select **Robot > Robot Installation Pose**. The robot installation pose can be entered manually or calculated automatically.

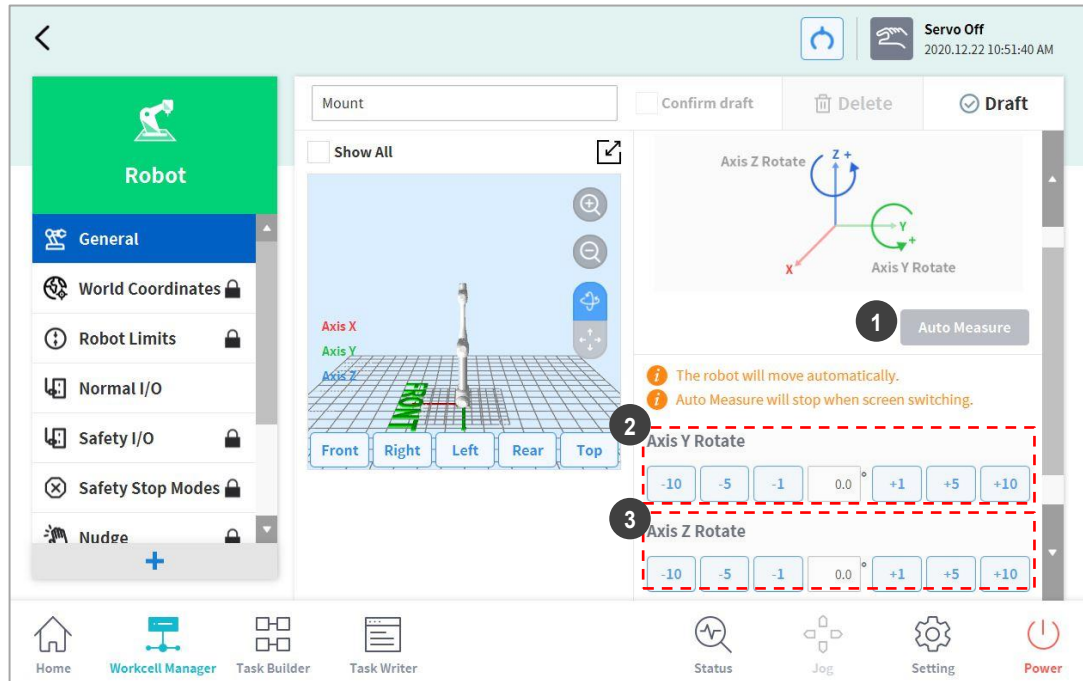

No.	Item	Description
1	Auto Calculate	Calculates the robot installation angle automatically.
2	Y-axis Rotation Setting	Enter the Y-axis angle of the robot during installation.
3	Z-axis Rotation Setting	Enter the Z-axis angle of the robot during installation.

Note

- Tap the **Auto Calculate** button to calculate the inclination value automatically. The installation pose Auto Calculate function can be used when the robot base is inclined from the ground by more than 5 degrees. The Auto Calculate function for robot installation pose allows easy configuration of the installation pose required by direct teaching, force control and compliance control functions without entering accurate installation angle values, but the absolute position accuracy of the automatically calculated robot pose setting may be lower than that of accurately measured values.

Version H Series

The H Series models do not support robot installation pose functions. Installation must be done on the ground.

Version A Series

- Auto Calculate is not supported in models without Force Torque Sensors.

7.5.7 Tool Shape Setting

To set the robot tool shape, tap the **+** Add button on the **Robot Workcell** and select **Robot > Tool Shape**. The Safety Password is required during setup.

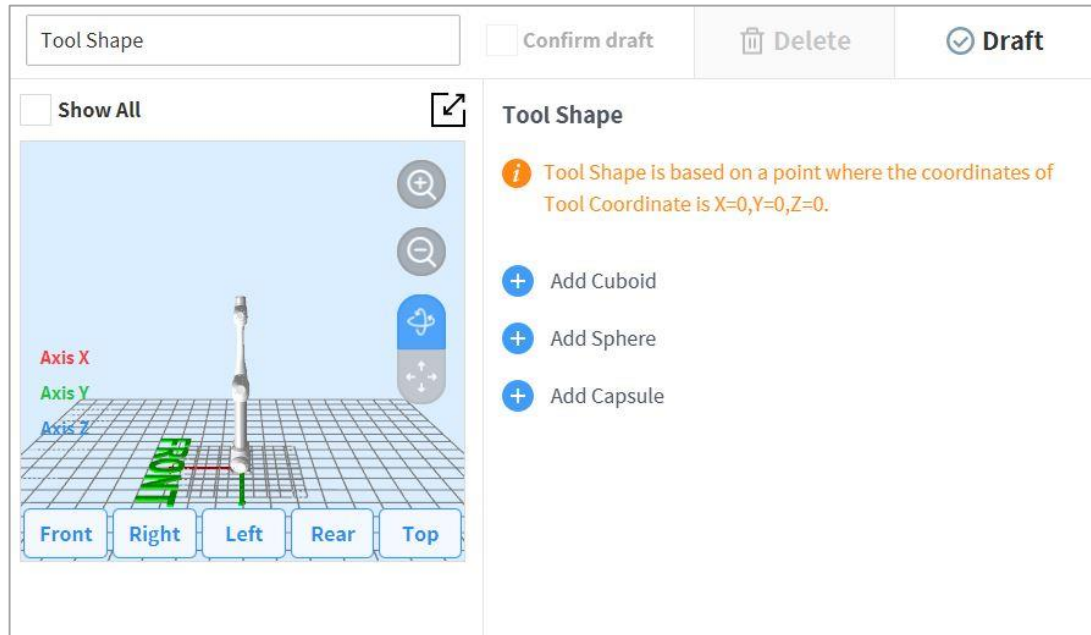

Tool shape can be set by adding Cuboid, Sphere, and Capsule shapes.
Select a shape that matches the tool and tap the Confirm button.

7.5.8 Tool Weight Setting

To configure the robot tool weight, tap the  “Add” button on the **Robot** Workcell and select **Robot > Tool Weight**.

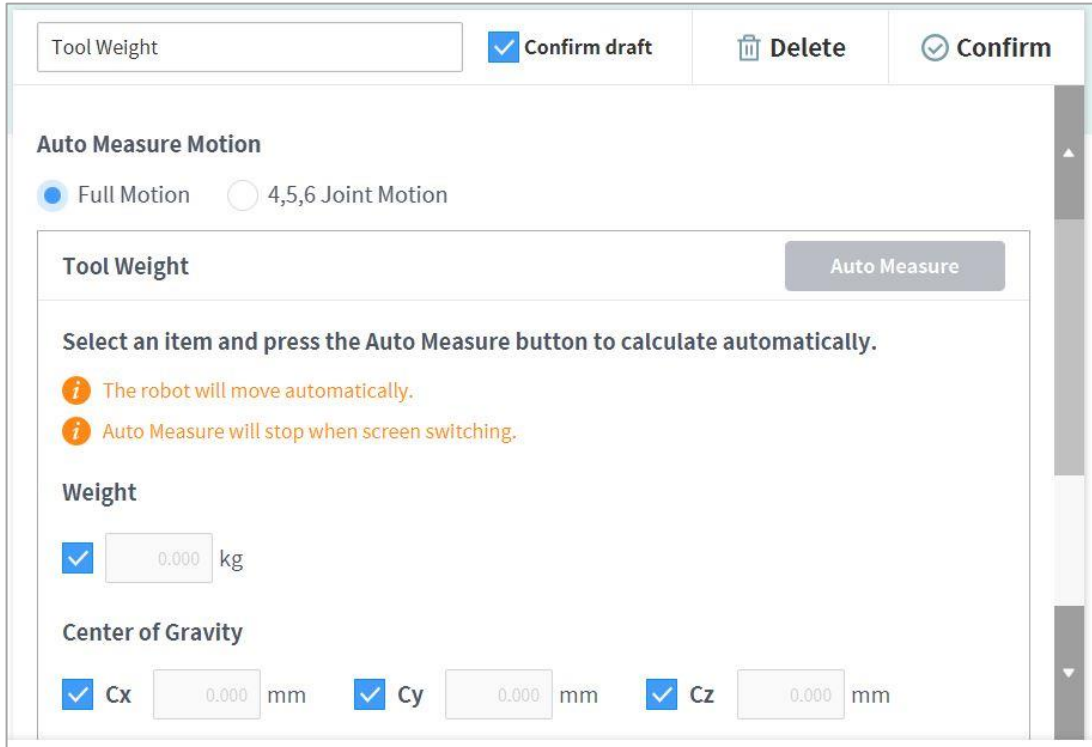

Tool Weight

Confirm draft Delete Confirm

Auto Measure Motion

Full Motion 4,5,6 Joint Motion

Tool Weight

Select an item and press the Auto Measure button to calculate automatically.

 The robot will move automatically.

 Auto Measure will stop when screen switching.

Weight

kg

Center of Gravity

Cx mm Cy mm Cz mm

Auto Tool Weight Measurement:

- 1 Select an Auto motion calculation method.
 - All Motion: All joints are used to measure tool weight.
 - **4, 5, 6 Motion**: Joints 4, 5 and 6 are used to measure tool weight.
- 2 Enable the checkbox of the parameter (weight, center of gravity) to estimate.
 - It is possible for the user to enter a known parameter value without enabling the checkbox.
 - If the user enters a known parameter, the values for parameters with their checkboxes enabled calculate the weight or center of gravity according to the entered parameter value.
- 3 Tap the **Auto Calculate** button.



Warning

- If the Auto Calculate checkbox for weight is disabled, enter a positive real number. (the center of gravity can be a negative real number or 0)
- Remove all obstacles before executing auto calculate.
- To execute Auto Calculate of 4, 5 and 6, the 3-axis angle must be greater than +30 degrees or less than -30 degrees.

- Note that safety monitoring functions are disabled during Auto Calculate.
- During Auto Calculate, the Auto Calculate button becomes the Stop button, which allows the user to stop Auto Calculate. If calculation is stopped, the weight and center of gravity values are reset.

Version A Series

- A-Series does not feature Auto Calculate for weight.

Tool Weight

Weight

kg

Center of Gravity

Cx mm **Cy** mm **Cz** mm

Inertia

Ixx kg.m **Iyy** kg.m **Izz** kg.m

Ixy kg.m **Iyz** kg.m **Izx** kg.m

7.5.9 User Coordinates Setting

The coordinate representing the workpiece can be set. This coordinate is called User Coordinates, and it is different from World Coordinates. It is possible to set the pose of User Coordinates using the base or World Coordinates, and User Coordinates can be selected when teaching and moving using the robot from Task Builder and Task Writer. To set User Coordinates, tap the **+** Add button on the **Robot** Workcell and select **Robot > User Coordinates**.

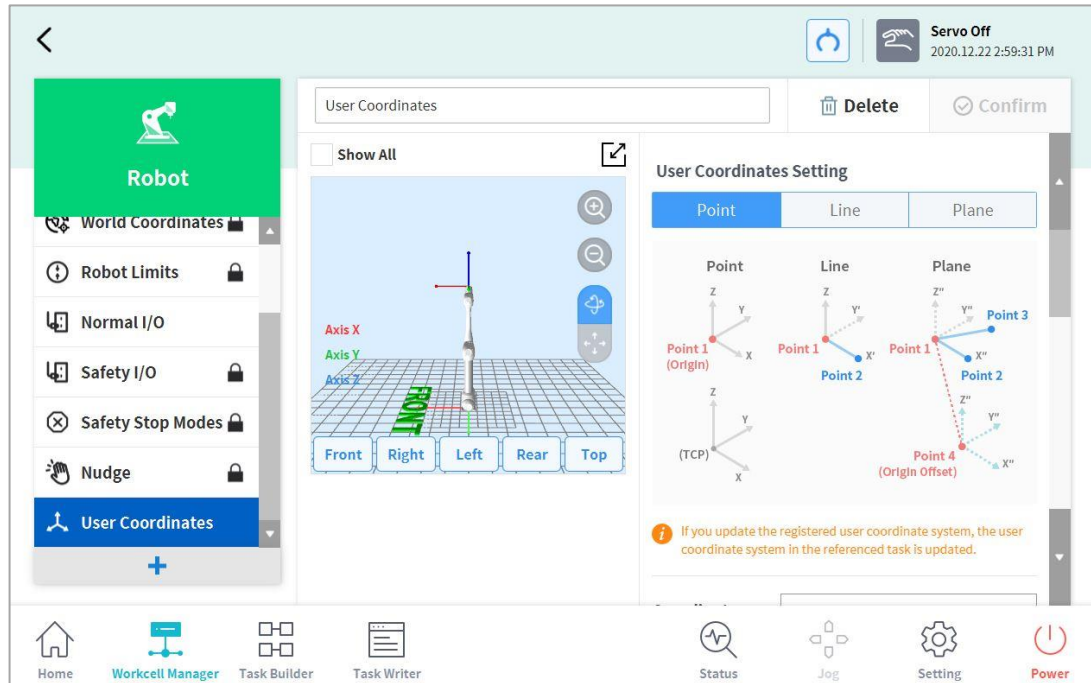

1. Enter the values required for settings.
2. Make sure to read the description image and cautionary items of the User Coordinates.
3. User Coordinates can be created based on 1-point, 2-points and 3-points.
4. It is possible to load pallet coordinates from Advanced Options and apply them to User Coordinates points.

7.5.10 Nudge Setting

If the robot is stopped by Safety Stop Mode SS2 or RS1 within a collaborative workspace, the work can be resumed with Nudge input. Nudge option can be enabled on user defined sections.

To set Nudge, select the **Nudge** item from the **Robot** Workcell. With nudge input, the force to be recognized (nudge force) and the standby time from nudge recognition and until the resuming the work (delay time) can be entered additionally.

The force detected by the nudge input is 10.00 ~ 50.00N.

Input Force	<input type="text" value="10.00"/> N
Delay Time	<input type="text" value="2.0"/> sec



Warning

- Nudge must only be used only if approved through risk assessment.

Version A Series

- A-Series, which does not feature a Joint Torque Sensor, does not have Nudge settings in **Advanced options**.

7.5.11 Space Limit and Section Settings Overview

• Space Limit

In addition to the robot joint angle limit of “**7.5.2 Robot Limits Setting**”, it is possible to limit the robot's operating space to within the direct teaching coordinates.

If the robot violates the space limit using the jog or while operating automatically, it will stop according to the safety stop mode settings. During direct teaching with hand guiding, resistance can be felt when the robot reaches the boundaries of the designated space.

Using the **inspection point** setting, it is possible to set the space limit to either apply to the entire robot body or only to the TCP. Using the **effective space** setting, it is possible to select whether the inspection point cannot enter the designated space or cannot go out of the designated space. Using the **section margin** setting, an expanded volume can easily be specified from the designated coordinates.

If **enable dynamic section** is selected, that section is enabled according to the input signal of the selected safety I/O port. If a HIGH signal input is made in the selected port, the corresponding section is enabled, but if a LOW signal input is made in the selected port, the corresponding section is disabled, operating as if a section is not designated.

• Section Settings

Depending on the application, it may be necessary to set a safety limit different from the global safety limit designated by “**7.5.2 Robot Limits Setting**” in certain spaces. It is possible to set a separate safety limit only in the designated section using the section setting function. Overridable safety limits are designated depending on the section type.

- **Collaborative Work space:** This is a workspace where the robot and operator can work together. The task speed and joint speed can be set to automatically decelerate at the set deceleration rate, and it is possible to override the collision detection sensitivity, TCP force limit and safety stop mode. Sections that are not set as collaborative work spaces are treated as single work spaces.
- **Protection Section:** This is a special collaborative work space where a TCP speed of less than 200 mm/s, a collision detection sensitivity of 100%, and safety stop mode RS1 are fixed. By setting protection sections near the robot work position and obstacle space, the risk of trapping can be reduced.
- **Collision Sensitivity Reduction Section:** In a space set as a collision sensitivity section, collision detection can be disabled or set to a lower sensitivity. This can be used when the robot must come in contact with the workpiece and apply force.
- **Tool Direction Change Limit Section:** If the tool center point (TCP) exits the tool direction change limit threshold, the robot stops according to the safety setting, which is configured in **Settings** on the main menu. This can be used to reduce risks related to the direction of the workpiece or tool of the robot.
- **Custom Section:** Various safety limits can be overridden, depending on the application.

Using the **effective space** setting, it is possible to designate whether to override the safety limit inside the section or outside the section. Using the **section margin** setting, an expanded volume can easily be specified from the designated coordinates.

Sections with overridden safety limits have the following priorities:

- If a section is set to partially override the safety limit, the set safety limit has priority over the global safety limit.
- The overridden safety limit of a priority section has priority over an overridden safety limit of a section without a designated priority.
- If there are multiple overridden safety limits on a specific location due to overlapping sections without designated priorities, the safest section has priority over others.
- If there are multiple overridden safety limits on a specific location due to overlapping sections with designated priorities, the section with the lowest safety limit has priority over others.



Warning





If multiple sections with designated priorities overlap, the safety function operates with the lowest of the overridden safety limits as a reference. Each section with a designated priority must have a minimum size set for safety.

If **Enable Dynamic Section** is selected, the section is enabled according to the input signal of the selected safety I/O port. If a HIGH signal input is made in the selected port, the corresponding section is enabled, but if a LOW signal input is made in the selected port, the corresponding section is disabled, operating as if a section is not designated.

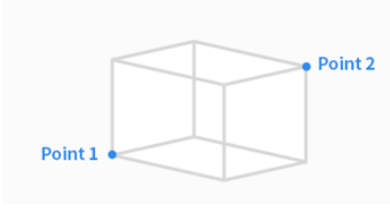
• Space Limit and Section Shape

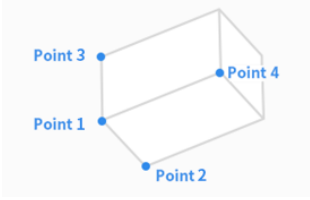
The space limit and section shape are set according to the following:

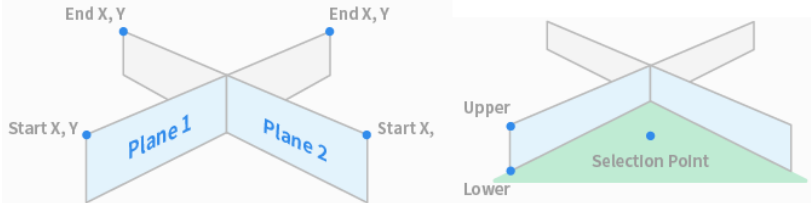
Item	Description
<p>Cuboid</p>	<p>The space limit/section shape is set as a cuboid.</p> <ul style="list-style-type: none"> • Enter the lower endpoint (Point 1) and upper endpoint (Point 2) of the cuboid and tap the Save Pose button. 
<p>Tilted Cuboid</p>	<p>The space limit/section shape is set as a tilted cuboid.</p> <ul style="list-style-type: none"> • Enter the reference point (Point 1), x-axis endpoint (Point 2), y-axis endpoint (Point 3), z-axis endpoint (Point 4) of the tilted cuboid and tap the Save Pose button. • The three lines (Point 1-Point2, Point 1-Point 3, Point 1-Point 4) must cross each other at right angles. (a deviation of +/- 5 degrees is acceptable) • Using the restraining motion of “Surface Lock” and “Axis Lock” based on Point 1 will help the robot obtain Point 2, Point 3 and Point 4 more easily. •

Item	Description
	
<p>Cylinder</p>	<p>The space limit/section shape is set as a cylindrical.</p> <ul style="list-style-type: none"> Enter the point at a radius distance, the point of the upper plane and the point of the lower plane of the cylinder, and tap the Save Pose button. 
<p>Multi-plane Box</p>	<p>The space limit/section shape is set as a multi-plane box.</p> <ul style="list-style-type: none"> Set the height of the top and bottom of the multi-plane box and press the Add Pose button to add a plane. Select X and Y coordinates to set the direction of the plane and tap the Save Pose button. Up to six planes can be configured. Set the coordinates for the points of the area to be configured. 
<p>Sphere</p>	<p>The space limit/section shape is set as a sphere.</p> <ul style="list-style-type: none"> To configure the radius, enter the positions of the center point and endpoint of the sphere, and to configure the diameter, enter two endpoints of the sphere, then tap the Save Pose button. 

7.5.12 Space Limit Settings

To set space limits for the robot, tap the  Add button on the **Robot** Workcell and select **Space Limit**>**Cube, Cylinder, Multi-plane Box, Sphere or Tilted Cube**. The safety password is required during setup and activation.

- 1** Enter the Workcell Name in the Workcell Name field on the top of the Workcell Setting screen.
- 2** Set the pose information according to the **space limit** shape along with the **inspection point, effective space** and **inspection margin** in the **Shape** tab.
- 3** Set the **Enable Dynamic Section** and **Advanced Options** in the **Properties** tab, and press **Confirm**.
- 4** Press the Activate Toggle button to apply the space limit.

Note

There are zone margin defaults depending on the setting methods.

- If the tool shape is set and Body volume check is not selected, TCP margin is 0 mm.
- If the tool shape is set and Body volume check is selected, TCP margin is 0 mm.
- If the tool shape is not set and Body volume check is not selected, TCP margin is 0 mm.
- If the tool shape is not set and Body volume check is selected, TCP margin is 60 mm.

7.5.13 Collaborative Workspace Settings

To set the collaborative workspace, tap the  Add button on the **Robot** Workcell and select **Collaborative Workspace > Cuboid, Cylinder, Multi-plane Box, Sphere or Tilted Cube**. The safety password is required during setup and enablement.

- 1** Enter the Workcell Name in the Workcell Name field on the top of the Workcell Setting screen.
- 2** Set the pose information according to the **section** shape along with the **effective space** and **section margin** in the **Shape** tab.
- 3** Set the **tool center point/robot limit, safety stop mode** and **enable the dynamic section** in the **Properties** tab, and press **Confirm**.
- 4** Press the Activate Toggle button to apply the collaborative workspace.

7.5.14 Protection Section Settings

To set the protection section, tap the  Add button on the **Robot** Workcell and select **Protection Section > Cuboid, Cylinder, Multi-plane Box, Sphere or Tilted Cube**. The safety password is required during setup and enablement.

- 1** Enter the Workcell Name in the Workcell Name field on the top of the Workcell Setting screen.
- 2** Set the pose information according to the **section** shape along with the **effective space** and **section margin** in the **Shape** tab.
- 3** Set the **tool center point/robot limit, safety stop mode, and enable the dynamic section and advanced options** in the **Properties** tab, and press **Confirm**.
- 4** Press the Activate Toggle button to apply the protection section.

7.5.15 Collision Sensitivity Reduction Section Settings

To set the collision sensitivity reduction section, tap the  Add button on the **Robot** Workcell and select **Collision Sensitivity Reduction Section**> **Cuboid, Cylinder, Multi-plane Box, Sphere or Tilted Cube**. The safety password is required during setup and enablement.

- 1 Enter the Workcell Name in the Workcell Name field on the top of the Workcell Setting screen.
- 2 Set the pose information according to the **section** shape along with the **effective space** and **section margin** in the **Shape** tab.
- 3 Set the **override option, tool center point/robot limit and enable the dynamic section** in the **Properties** tab and press **Confirm**.



Warning

The section with reduced collision sensitivity is a priority section.

If multiple sections with designated priorities overlap, the safety function operates with the lowest of the overridden safety limits as a reference. Each section with a designated priority must have a minimum size set for safety.

- 4 Press the Activate Toggle button to apply the collision sensitivity reduction section.

7.5.16 Tool Direction Change Limit Section Settings

To set the tool direction change limit section, tap the  Add button on the **Robot** Workcell and select **Tool Direction Change Limit Section** > **Cuboid, Cylinder, Multi-plane Box, Sphere or Tilted Cube**. The safety password is required during setup and enablement.

- 1** Enter the Workcell Name in the Workcell Name field on the top of the Workcell Setting screen.
- 2** Set the pose information according to the **section** shape along with the **effective space** and **section margin** in the **Shape** tab.
- 3** Set the **TCP direction limit** and **enable the dynamic section** in the **Properties** tab and select **Confirm**.
- 4** Press the Activate Toggle button to apply the tool direction change limit section.

7.5.17 Custom Section

To set the tool direction change limit section, tap the  Add button on the **Robot** Workcell and select **Custom Section > Cuboid, Cylinder, Multi-plane Box, Sphere or Tilted Cube**. The safety password is required during setup and enablement.

- 1 Enter the Workcell Name in the Workcell Name field on the top of the Workcell Setting screen.
- 2 Set the pose information according to the section shape along with the **effective space** and **section margin** in the **Structure** tab.
- 3 To import shape setting configurations from a different area, select a different Workcell item from **Import Shape and Property** in the **Advanced Options** and press **Import**.

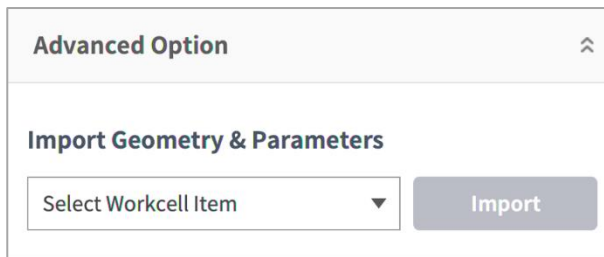

- 4 Set the **priority option, override option, tool center point/robot limit, safety stop mode, TCP direction limit, nudge option, joint angle speed limit and joint angle limit** and enable the **dynamic section** in the **Properties** tab and press **Confirm**.



Warning

If multiple sections with designated priorities overlap, the safety function operates with the lowest of the overridden safety limits as a reference, so the section with designated priority must be set to the minimum size.



Note

The following regulations are applied if multiple zones overlap.

- 1) Normal Mode
 - ◆ If there is no zone set as a "High Priority Zone," the safest limit among zones is set as the inspection standard.
 - ◆ If there is 1 zone set as a "High Priority Zone," the limit of this zone is set as the inspection standard.
 - ◆ If there are 2 or more zones set as "High Priority Zones," the unsafest limit among these zones is set as the inspection standard.
- 2) Deceleration Mode
 - ◆ If there is no zone set as a "High Priority Zone," the safest limit between the safest limit among zones and the global deceleration limit is set as the inspection standard.
 - ◆ If there 1 zone set as a "High Priority Zone," the inspection standard is set according to the "Global Deceleration Mode Setting Override."
 - If there is no zone with a "Global Deceleration Mode Setting Override," the limit of the zone set as a "High Priority Zone" is set as the inspection standard.
 - If there is a zone with the "Global Deceleration Mode Setting Override," the safest limit between the safest limit among zones and the global deceleration limit is set as the inspection standard.

- ◆ When there are more than 2 zones set as "High Priority Zones,"
 - if there is no zone with the "Global Deceleration Mode Setting Override," the unsafest limit among zones set as "High Priority Zones" is set as the inspection standard.

If there is a zone with the "Global Deceleration Mode Setting Override," the safest limit between the safest limit among zones and the global deceleration limit is set as the inspection standard.

- 5 Press the Activate Toggle button to apply the custom section.

7.6 End Effector Setting

The end effector is a device that acts directly on the target using the tool attached to its tool flange to execute the task the user configured for the robot, and there are grippers (pneumatic gripper, vacuum gripper) and tools (screwdriver, gluing tool).

7.6.1 Grippers and Tools

Grippers are end effectors that have fingers to pick up or drop objects. The following is the setting screen for a pneumatic gripper. This example will be used as the basis for explaining how to configure an end effector. For more information about each gripper setting, refer to the separate manuals provided.

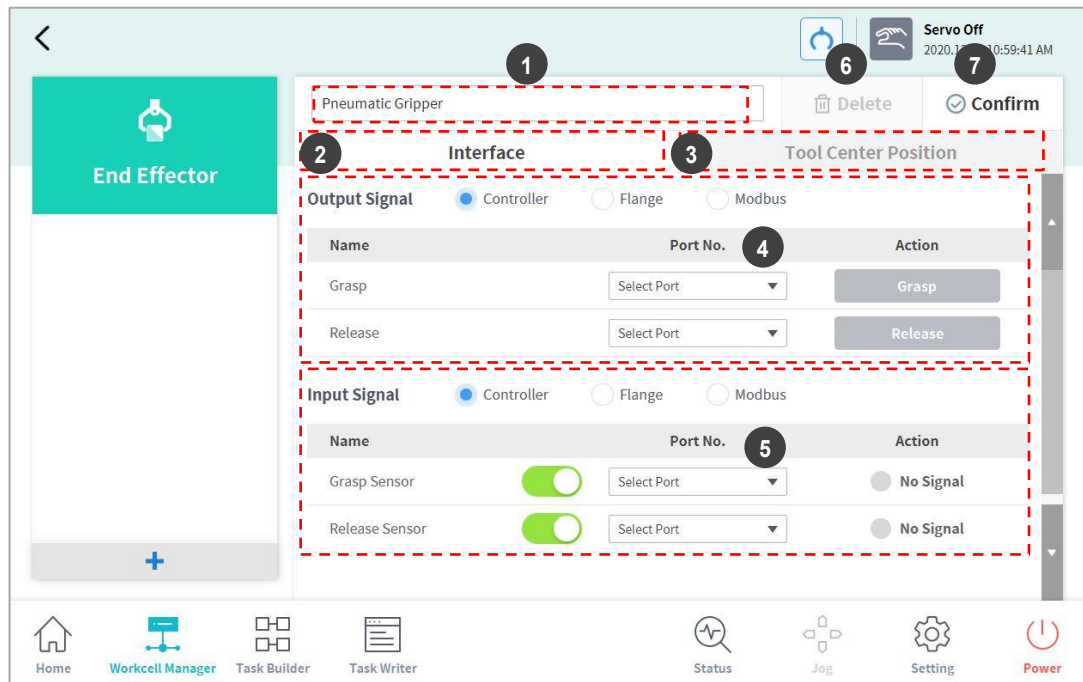

No.	Item	Description
1	Workcell Name Input Field	Enter the name of the end effector.
2	Communication	Sets the I/O signal of the end effector.
3	Tool Center Point	Sets the tool center point (TCP) of the end effector.
4	Output Signal	<p>Checks and sets the output signal.</p> <ul style="list-style-type: none"> • Output Signal: Sets the output signal type (controller, flange, Modbus). • Name: Displays the output signal name. • Port Number: Select the end effector output signal port. <p>Operation: Tests the output signal status.</p>

No.	Item	Description
5	Input Signal	<p>Checks and sets the input signal.</p> <ul style="list-style-type: none"> • Input Signal: Sets the output signal type (controller, flange, Modbus). • Name: Displays the output signal name. The signal can be turned on or off by pressing the toggle button. • Port Number: Select the end effector output signal port. • Operation: Displays the input signal status. If the signal is normal, it is displayed as green.
6	Delete	Deletes the end effector being configured.
7	Confirm	Saves the setting.

Tools include a screwdriver, gluing tool, deburring tool, and polish and air blow nozzle, and there is also a custom tool setting function to allow the use of other user tools. Configuring tool settings is similar to that of gripper settings.

For more information about each tool setting, refer to the separate manuals provided.

7.6.2 End Effector I/O Signal Setting

- 1 Tap the Add (+) Workcell button at the bottom of the end effector of the Workcell Manager.
- 2 Enter the Workcell name in the Workcell Name field at the top of the Workcell Setting screen.



A screenshot of the Workcell Name field. The text 'Pneumatic Gripper' is entered in a white input box. To the right of the input box are two buttons: a 'Delete' button with a trash icon and a 'Confirm' button with a checkmark icon.

- 3 Connect the end effector port to the robot flange or controller
- 4 Select the I/O signal type and select the I/O port number.

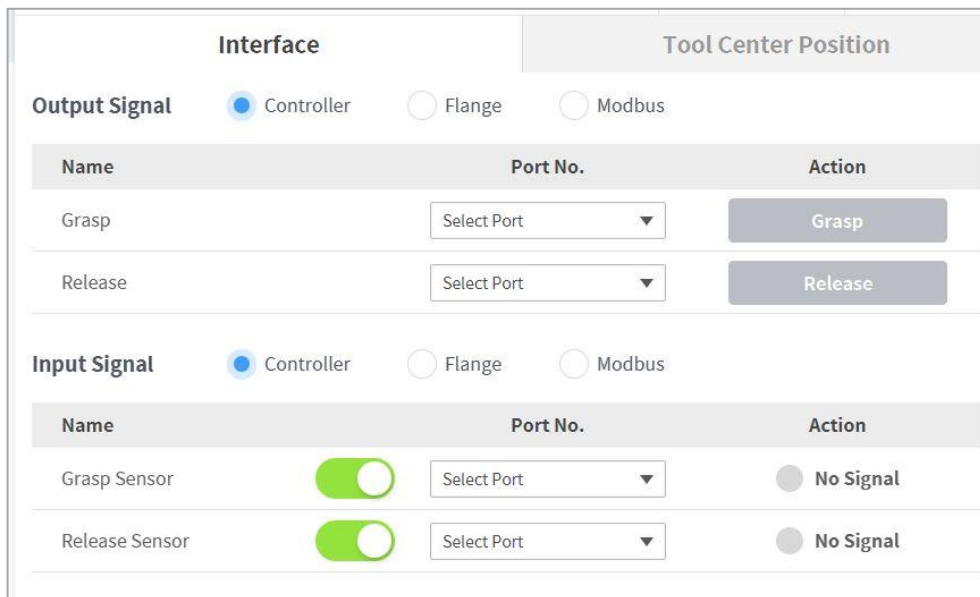

A screenshot of the Workcell Setting screen. The screen is divided into two tabs: 'Interface' (selected) and 'Tool Center Position'. Under the 'Interface' tab, there are two sections: 'Output Signal' and 'Input Signal'. Each section has radio buttons for 'Controller', 'Flange', and 'Modbus'. The 'Output Signal' section has a table with columns 'Name', 'Port No.', and 'Action'. The 'Input Signal' section has a table with columns 'Name', 'Port No.', and 'Action'. The 'Grasp Sensor' and 'Release Sensor' rows in the 'Input Signal' table have green toggle switches and 'No Signal' in the 'Action' column.

Output Signal		
Name	Port No.	Action
Grasp	Select Port	Grasp
Release	Select Port	Release

Input Signal		
Name	Port No.	Action
Grasp Sensor	Select Port	No Signal
Release Sensor	Select Port	No Signal

- 5 Tap the **Confirm** button.

7.6.3 End Effector I/O Testing

To test the operation status of the connected end effector, follow the procedure below.

- 1 Select the end effector to test and tap the **Edit** button.



- 2 Tap the **Operate** button to test the output signal.

Name	Port No.	Action
Grasp	1	<input type="button" value="Grasp"/>
Release	2	<input type="button" value="Release"/>

- 3 Check whether the end effector receiving the output signal operates normally.

Note

- If the input signal is entered properly, a green indicator lights up.

7.6.4 Tool Center Point(TCP) Setting

When configuring the tool center point (TCP), the position and rotation angle based on the flange coordinates must also be defined. The distance from the default starting point of the flange coordinate to the tool center point (TCP) in the X, Y and Z directions cannot be set to be greater than 10000 mm. In addition, if the converted lengths ($L = \sqrt{X^2 + Y^2 + Z^2}$) of X, Y and Z are less than 300mm, force control, compliance control, and direct teaching-point lock functions can be executed.

In particular, if the TCP is configured using **Auto Calculate**, the calculation is made based only on the X, Y and Z positions, so it is necessary to enter the rotation angle. The rotation angle can be defined with items A, B and C, and it is based on the Euler Z-Y-Z rotation method.

The screenshot shows a software interface for configuring a tool center point. At the top, there is a text input field containing 'Gluing Tool', a 'Delete' button with a trash icon, and a 'Confirm' button with a checkmark icon. Below this is a tabbed interface with two tabs: 'Interface' and 'Tool Center Position'. The 'Tool Center Position' tab is active. Under the 'Position' heading, there are input fields for X (0.000mm), Y (0.000mm), and Z (0.000mm). To the right of these are three rotation angle fields: A (0.0°), B (0.0°), and C (0.0°). These three rotation angle fields are enclosed in a red dashed rectangular box. Below the position fields is an 'Auto Calculation' section with a toggle switch currently turned off and a radio button selected for 'Reference Pose'. Underneath is a table with four rows labeled 'Point 1' through 'Point 4'. Each row contains three buttons: 'Get Pose' (with a circular arrow icon), 'Move To Pose' (with a downward arrow icon), and 'Reset' (with a dropdown arrow icon). At the bottom of the interface is a large 'Auto Calculation' button.

The definitions of the coordinate axis expressed with x, y, z and coordinate axis expressed with X, Y, Z are as follows:

- Coordinate axis of “Flange Coordinate” (x, y, z): The coordinate axis direction defined at the end of the flange is identical to the robot coordinate with a robot joint angle of (0,0,0,0,0,0).
- Coordinate axis of “TCP Coordinate” (X,Y,Z): The coordinate axis is defined at the end of the tool installed on the end of the flange or working point. The rotation angle of the “TCP Coordinate” is defined based on the “Flange Coordinate” in the order of 1) to 3) of the following:

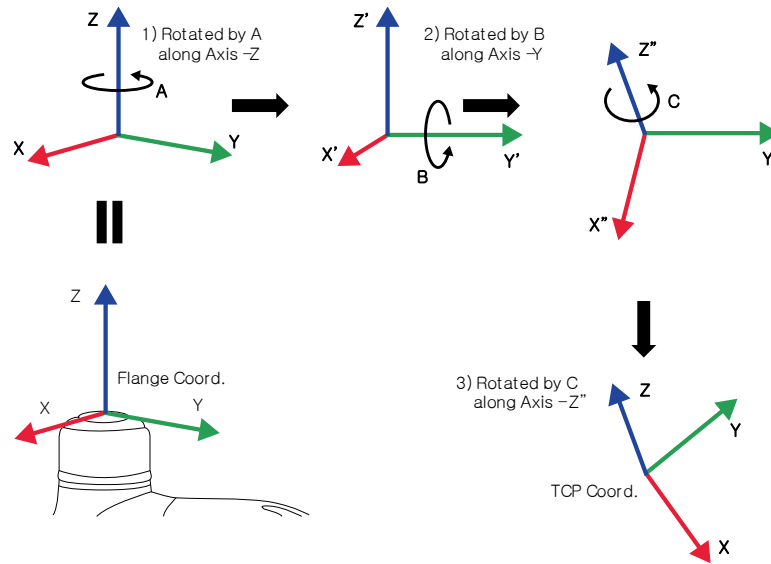

- 1) Rotate A degrees along the z axis of the Flange Coordinate
- 2) Rotate B degrees along the y' axis of the coordinate rotated according to 1)
- 3) Rotate C degrees along the z'' axis of the coordinate rotated according to 2)

Here are a few examples of configuring the TCP according to the method described above:

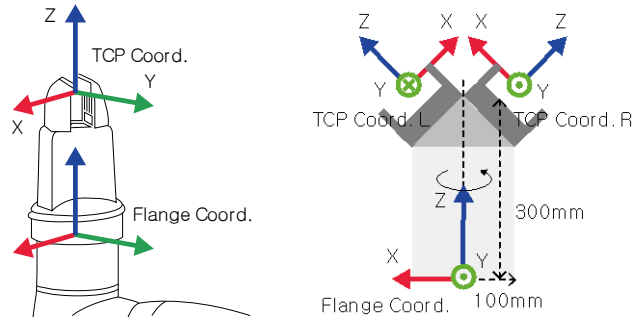

- $[X, Y, Z, A, B, C] = [0, 0, 100, 0, 0, 0]$: General Gripper with Z-direction offset (TCP Coord)
- $[X, Y, Z, A, B, C] = [100, 0, 300, 180, 45, 0]$: Left Gripper with 45-degree angle (TCP Coord. L)
- $[X, Y, Z, A, B, C] = [-100, 0, 300, 0, 45, 0]$: Right Gripper with 45-degree angle (TCP Coord. R)

7.6.5 Tool Center Point Setting based on Other End Effectors

When using a symmetrical double gripper, the TCP of an end effector is configured based on the other well-configured end effector. The TCP position of a new end effector can be easily configured by rotating the pose and point on the tool coordinate at the base end effector TCP point on the Z axis by the angle entered.

- 1 Select the **Tool Center Point** tab on the end effector setting screen.

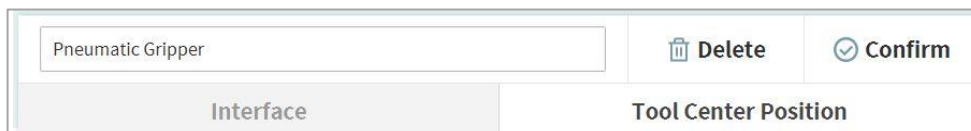

The screenshot shows a settings interface for a 'Pneumatic Gripper'. At the top, there is a text input field containing 'Pneumatic Gripper', a 'Delete' button with a trash icon, and a 'Confirm' button with a checkmark icon. Below this, there are two tabs: 'Interface' and 'Tool Center Position'. The 'Tool Center Position' tab is currently selected and highlighted.

- 2 Tap the **Auto Calculate** toggle switch.



The screenshot shows a toggle switch labeled 'Auto Calculation'. The switch is currently turned on, indicated by a green circle on the right side of the slider.

- 3 Select the **Reference End Effector** item.

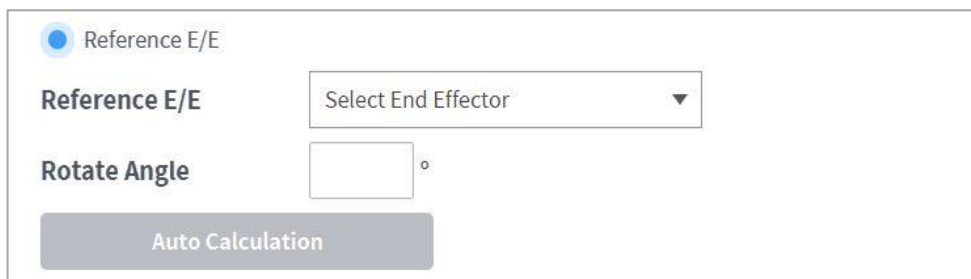

The screenshot shows a configuration screen for the 'Reference End Effector'. It features a radio button labeled 'Reference E/E' which is selected. Below it is a dropdown menu labeled 'Reference E/E' with the text 'Select End Effector' and a downward arrow. There is also a text input field labeled 'Rotate Angle' with a degree symbol (°) to its right. At the bottom, there is a grey button labeled 'Auto Calculation'.

- 4 Select the end effector to copy.



The screenshot shows a dropdown menu labeled 'Reference E/E' with the text 'Select End Effector' and a downward arrow.

- 5 Configure the tool Z-axis rotate angle of the configuring end effector and reference end effector.



The screenshot shows a text input field labeled 'Rotate Angle' with a degree symbol (°) to its right.

- 6 Click the **Auto Calculate** button on the bottom, check whether the calculated TCP is automatically entered and tap the **Confirm** button.



The screenshot shows a table titled 'Position' with the following values:

Axis	Value
X	-100.000mm
Y	0.000mm
Z	50.000mm
A	180.00°
B	45.00°
C	0.00°

Note

- The configuring end effector and base end effector must be symmetrical on the tool Z axis.

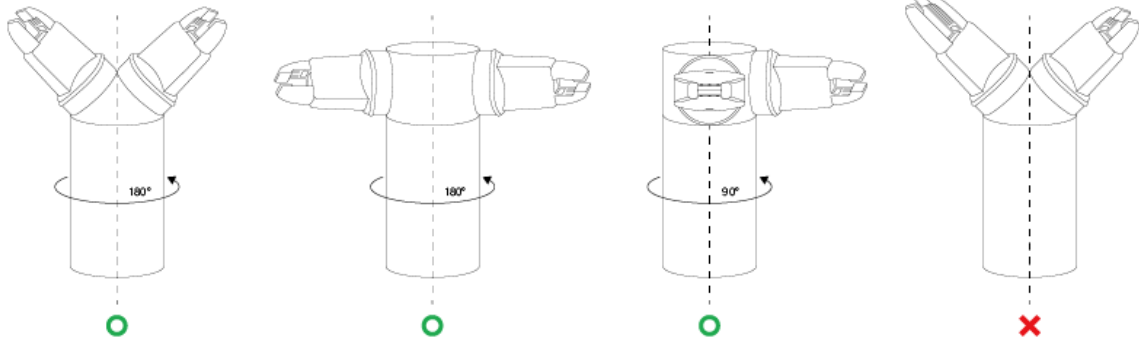

7.7 Machine Tool Setting

Machine tools are the main work devices that interact with the robot, and the machine tools that can be registered in the Workcell Manager are as follows:

Category	Type	Description
Turning Center	Turning Center	It turns cylindrical materials to allow the material to be cut to the desired shape using a tool turret.
Press Machine	Press Machine	This is a machine that compresses a flat material to form a desired shape.
Injection Molding Machine	Injection Molding Machine	This is a device that injects materials such as plastic into a mold and forms it into the desired shape.

Machine tool settings are similar to those of the gripper settings.
For more information about each machine tool setting, refer to the separate manuals provided.

7.8 Peripheral Setting

Peripherals are Workcell items that are not categorized as a robot, end effector or machine tool, but interact with the robot. Peripherals that can be registered in the Workcell Manager are as follows:

Category	Type	Description
Feeder	Shooting Bolt Feeder	This is a device that supplies bolts to the end of a screwdriver using a tube and air pressure.
	Pallet	This is a cradle that allows the target to be placed in a set formation.
	Pallet (Square)	This is a pallet that organizes items in a square.
	Pallet (Stack)	This is a pallet that organizes items in stacks.
	Pick-up Bolt Feeder	This is a device that supplies bolts for screwdriving.
	Linear Pattern	This is a pallet that organizes items in a linear pattern.
Others	Button	This is a device that sends On/Off signals.
	External Encoder	Externally installed Encoder Setting
Safety Equipment	-	These are equipment that enhance user safety such as safety mats and laser curtains.
Vision	Smart Vision Camera	This is a device that corrects the target position based on video information.
Conveyor Tracker	Conveyor Tracker	Externally installed Conveyor Operation Setting

The following is the setting screen for the **Pallet**. This example will be used as the basis for explanation.
For more information about each feeder setting, refer to the separate manuals provided.

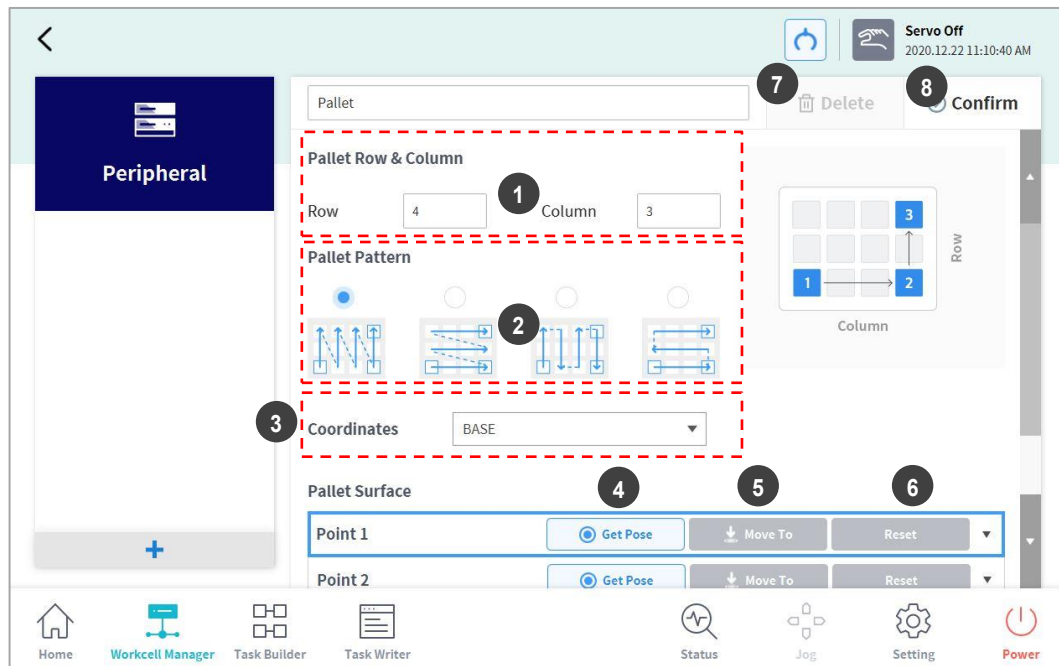

No.	Item	Description
1	Pallet Matrix	Enter the number of rows and columns of pallets.
2	Pallet Pattern	Select the robot's movement pattern on the pallet.
3	Base Coordinate	Select the base coordinates of the pallet.
4	Save Pose	Saves the coordinate corresponding to the current robot pose.
5	Move	Moves the robot to the coordinates entered below. Enter the coordinates below and press and hold the Move button.
6	Reset	Resets the robot coordinates to the default values.
7	Delete	Deletes the current Workcell.
8	Confirm	Saves the Workcell settings.

- 1 Enter the number of rows and columns of pallets.
- 2 Select the pallet pattern.
- 3 Select the base coordinates of the pallet.
- 4 Move the robot TCP to Point 1 of the pattern guide to the right side of the pallet pattern.

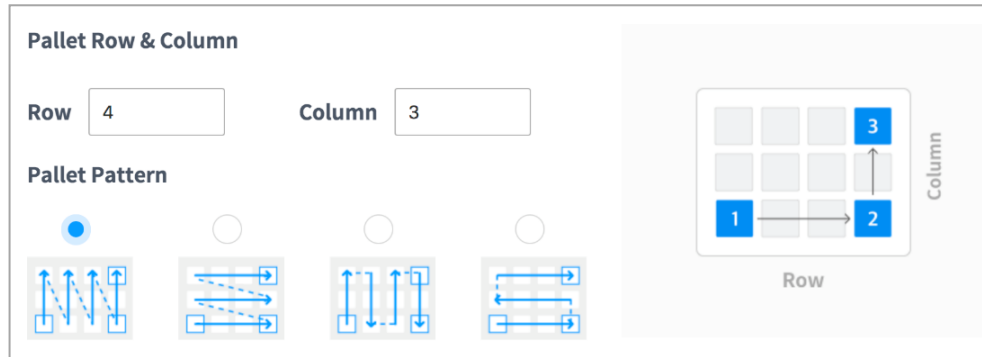

- 5 Tap the **Save Pose** button in **Point 1** of the **Pallet Reference Point**.
 - The coordinates of the corresponding position are entered as **Point 1**.

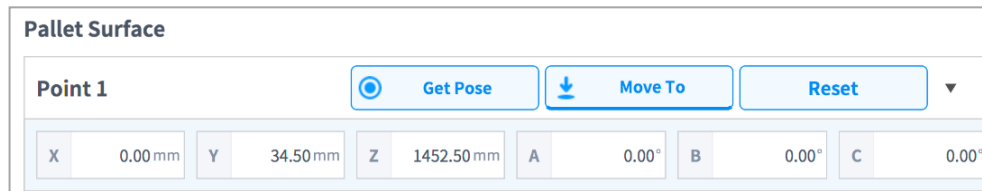

- 6 Move the robot TCP to Point 2 of the pattern guide and tap the **Save Pose** button of **Point 2**.
 - Enter the coordinates of Point 3 of the pattern guide the same way.
- 7 Tap the **Confirm** button.

7.8.1 Others

The others category includes **Button**. The others category settings are similar to those of the gripper settings. For more information about the others category, refer to the separate manuals provided.

7.8.2 Vision

For more information about vision setting, refer to the Reference Manual provided separately.

8. Task Builder

After registering and configuring all Workcell items in the **Workcell Manager**, a program to execute the robot task must be created using commands or skills.

With **Task Builder**, the user can create a new task, enter skills or commands, or create tasks using templates recommended by the system. For a detailed list of skills, commands and templates, refer to the manual provided separately.

To use Task Builder, tap  **Task Builder** on the main menu.

8.1 Task Management

8.1.1 Create New Task

To create a new task, follow these steps:

- 1 Tap **New** on the initial screen of **Task Builder**.
 - If a task is being edited, tap the  Menu button and tap **New**.
- 2 Select a Workcell item from the task to create and tap the > button to move the selected item to the list.
- 3 After selecting a Workcell item, tap **Next**.
- 4 Enter the name of the new task program in the **File Name** field.
- 5 Tap the **Confirm** button.

When a new task is created, the task edit screen is displayed. For more information on how to edit a task, refer to “**8.4 Edit Task**”.

8.1.2 Template

A template is a bundle of skills that compose a work procedure used with a combination of Workcell items when a particular Workcell item is registered. It is possible to easily create a task with the settings of skills already in the template without worrying about the work process.

To create a new task using a template, follow these steps:

- 1 Tap the **Template** on the initial screen of **Task Builder**.
- 2 Select a template to use.
 - Available templates vary according to the Workcell Items registered in the **Workcell Manager**. If no Workcell Item is registered in the **Workcell Manager**, no template will be displayed.



The image shows a screenshot of a software interface titled "Select Template". It features a list of available templates. The first and only visible item in the list is "1 Pneumatic Gripper". The interface has a light gray background and a white border.

- 3 Enter the name of the new task program in the **File Name** field.
- 4 Tap the **Confirm** button.

When a new task is created using a template, the task edit screen is displayed. For more information on how to edit a task, refer to "**8.4 Edit Task**"

8.1.3 Save Task

To save an edited task, tap the  Menu button and tap **Save**.

Note

- If the file is not saved for the first time, a confirmation window appears. Tap the **Confirm** button to save it to an existing file.

8.1.4 Save Task As

To save the task as a different file, follow these steps:

- 1 Tap the  "Menu" button and tap the **"Save as"** button.
- 2 When the **Save as** window appears, enter the task name and tap the **Confirm** button.

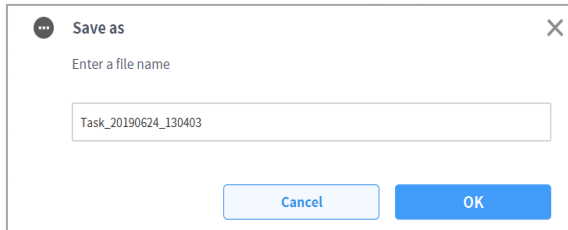

When the save is complete, the **Save Complete** window appears.

8.1.5 Editing Workcell Items

To view a Workcell item selected from the current task or to select or remove an additional Workcell item, please refer to the following:

- 1 Tap the  Menu button and press the selected Workcell item.
- 2 From the current task, it is possible to add or remove new Workcell items in the current task or Workcell list.

8.1.6 Save Task on External Storage Device

To save an opened task to an external storage device, follow these steps:

- 1 Connect an external storage device to the USB slot.
 - Only external storage devices with FAT32 file systems can be used.
- 2 Tap the  Menu button and tap **Export**.
- 3 After the **Export** window appears, select the drive of the external storage device and tap the **Confirm** button.
- 4 When the **Save as** window appears, enter the task name and tap the **Confirm** button.

When the save is complete, the **Save Complete** window appears.

Note

- The file extension of the saved task file is ".tb."

8.1.7 Load Saved Tasks

To load a saved task, follow these steps:

- 1** Tap **Saved Files** on the initial screen of the **Task Builder**.
 - If a task is being edited, tap the  Menu button and tap **Open**.
- 2** Select a task to open from the file list and tap the **Open** button.
- 3** Searches for tasks in the file list can be made using the filter function.
 - Search in latest, oldest, alphabetical order, and reverse order is possible.

8.1.8 Delete Saved Tasks

To delete a saved task, follow these steps:

- 1 Tap **Saved Files** on the initial screen of the Task Builder.
 - If a task is being edited, tap the  Menu button and tap **Open**.
- 2 Select a task to delete from the file list and tap the "**Delete**" button.

8.1.9 Import Tasks on External Storage Devices

To import a task saved on an external storage device, follow these steps:

- 1 Connect the external storage device with the task file to the USB slot.
- 2 Tap **Import** on the initial screen of Task Builder.
- 3 Tap the **Search** button.

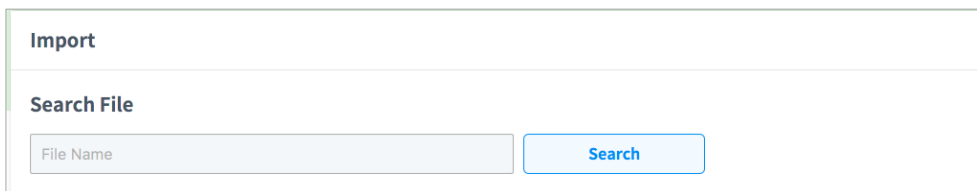

The screenshot shows a window titled "Import". Below the title is a section labeled "Search File". Inside this section, there is a text input field with the placeholder text "File Name" and a blue button labeled "Search".

- 4 When the **Search File** window appears, select the task to import and tap the **Confirm** button.

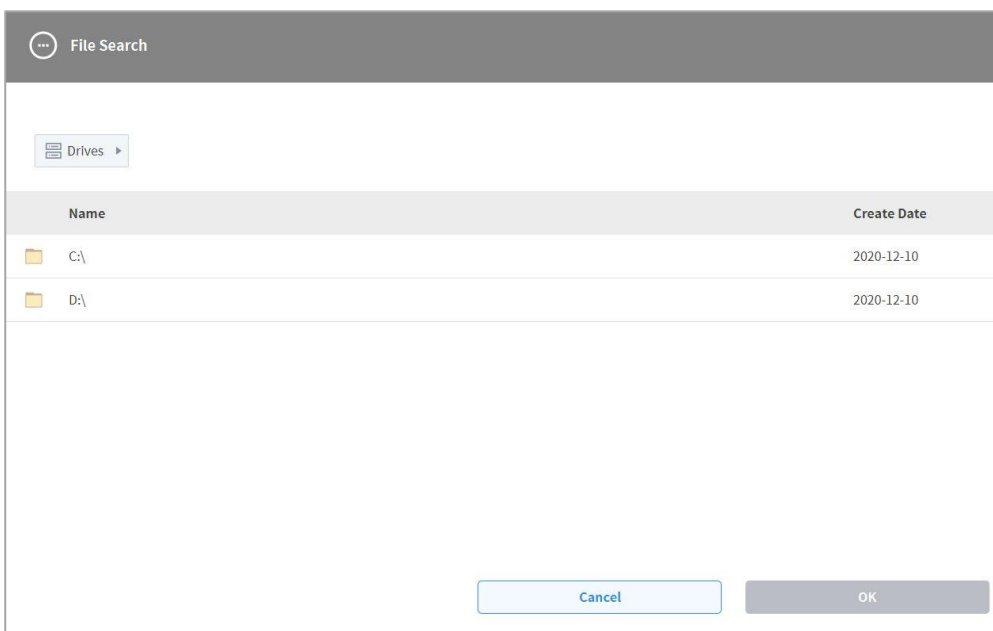

The screenshot shows a window titled "File Search". At the top, there is a "Drives" button with a right-pointing arrow. Below this is a table with two columns: "Name" and "Create Date".

Name	Create Date
C:\	2020-12-10
D:\	2020-12-10

At the bottom of the window, there are two buttons: "Cancel" and "OK".

- 5 Tap the **Import** button on the bottom right.

When the task file is saved on an external storage device, the **Save Complete** window appears.

To load a task file saved on the system, refer to “**8.1.7 Load Saved Tasks.**”

8.2 Task Builder Commands

The user can create task programs using motion commands, flow control and other commands and skill commands from Task Builder. For more information about commands, refer to the manual provided separately.

- **Motion Command:** These are commands used to adjust or change the robot's pose.

Move J	Used to move the robot to the target joint coordinates.
Move L	Used to move the robot along a line towards the target work space coordinate.
Move SX	Used to move the robot along a curved line connecting multiple via points and target points within the workspace.
Move SJ	Used to move the robot along a curved line connecting multiple via points and target points expressed as a joint coordinate.
Move C	Used to move the robot along an arc composed of a current point, via point and target point.
Move B	Used to move the robot along a line and arc connecting multiple via points and target points within the workspace.
Move Spiral	Used to move the robot along a path extending to the outer side from the center of a spiral.
Move Periodic	Used to move the robot along a path repeated periodically.
Move JX	Used to move the robot to the target workspace coordinate and joint form. This does not move along a straight line.
Stop Motion	This is used to stop task execution.

- **Flow Control and Other Commands:** These can control the task flow through task standby, repeat, executing commands included in the task and conditions.

If	This is used to branch according to a specific condition during task execution
Else If	This is used to branch according to a specific condition during task execution.
Repeat	This is used to repeat the task command.
Continue	This is used to return to the first command of a repetition statement (Repeat).
Break	This is used to exit the repeat execution command (Repeat).
Exit	This is used to end task execution.

Sub	This is used to define a thread within the task.
Call Sub	This is used to execute the defined thread.
Thread	This is used to end thread execution.
Run Thread	This is a command to define a thread within the task.
Kill Thread	This is a command to execute a defined subtask.
Sub Task	This is used to temporarily stop task execution.
Call Sub Task	This is used to receive user input and save it in a variable during task execution.
Wait	This is used to control the Function button.
User Input	This is used to branch according to a specific condition during task execution.
Watch Smart Pendant	This is used to repeat the task command.

- **Force Control Command:** The force of the robot can be controlled during task execution.

Compliance	This is used to control Compliance during task execution.
Force	This is used to control force during task execution.

- **Other Commands:** There are commands that weigh the item and receive user input.

Comment	This is used to save the user-designated information in a log during task execution.
Custom Code	This is used to insert and execute a DRL code during task execution.
Define	This is used to define a variable during task execution.
Popup	This is used to display a popup screen during task execution.
Set	This is used to execute various settings during task execution.
Weight Measure	This is used to measure the weight during task execution and save it in a variable.
Wait Motion	This is used to temporarily stop the robot after the previous motion command is complete.
GlobalVariables	This is used to add Global Variable.

- **Advanced Commands:** There is a command to execute Hand-guiding.

Hand Guide	This is used to execute direct teaching during task execution.
Nudge	This is used to delay task execution until Nudge (applying force to the robot) input.

- **Skill Commands:** These are commands predefined for each Workcell Item the user configured. When a skill command is used, it is possible to easily configure jobs related to the Workcell Item without complicated programming. To use command skills, it is necessary to configure the work and related Workcell items. For more information about skill command list and configurations, refer to the manual provided separately.

Version A Series

- In models without Force Torque Sensors, Rx, Ry and Rz values of **Weight Measure**, **Nudge**, **Compliance** commands, and A, B and C values of **Force** command are not supported.
- The **Watch Smart Pendant** command provides functions to control conditions using the Function button of the Smart Pendant.

8.3 Deprecated Skill Command

Skill commands can be updated due to increased usability and additional motion improvements. If a skill command is updated, the existing skill command becomes deprecated, and it cannot be added or edited. Deprecated skill commands are displayed as dimmed icons.

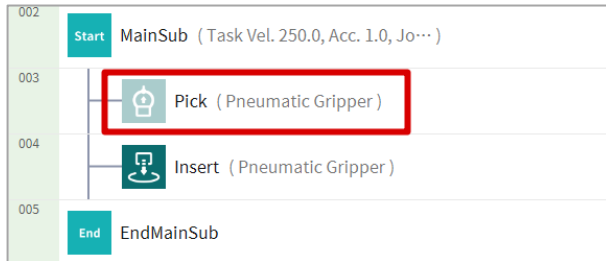

Deprecated skill commands cannot be added new, but can be used to view property information or be used in the current task program.

In the property window of a deprecated skill command, the phrase “Deprecated Item” is displayed.

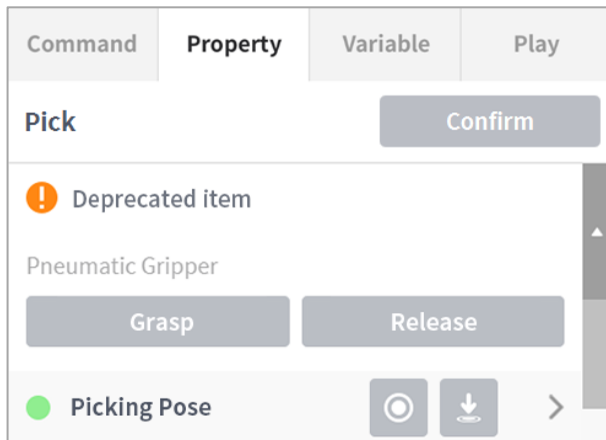

If a deprecated skill command is present, it is recommended to replace it with an updated skill command.

8.4 Edit Task

When a task is created, the user can add commands in the **Task List**, and when the Properties of the added command are configured, the task program can be executed. The **Task Builder** screen offers an edit function for adding/deleting/copying commands or changing the order of commands. The **Task Builder** commands consist of motion commands, flow control and other commands, and skill commands.

Note

When attempting to enter the **Home**, **Workcell Manager** or **Task Writer** screen, a message confirming whether to save the program being edited is displayed. **Jog** and **Settings** screens are displayed as popup windows. For more information about the **Status**, **Jog** and **Settings** popup windows, refer to “ **Note – Robot Work Status List**”

Check the robot status shown in the status display area. The information can be used as a reference when performing work using the robot.

- **Standby:** In this status, the robot can be operated, robot settings can be changed or motions can be tested.
- **In Operation:** In this status, the robot is operating, and robot settings cannot be changed.
- **Safety Off:** The power to the motor and brake are cut off, and the robot has stopped.
- **Safety Stop:** The robot has stopped due to an error or safety issue, so stop the current work and check the robot.
- **Emergency Stop:** the robot has stopped due to the activation of the emergency stop button.
- **Work Screen Area:** Refer to “5.2 Work Screen Area”

8.4.1 Edit Task Screen Configuration

The edit task screen of Task Builder is structured as follows:

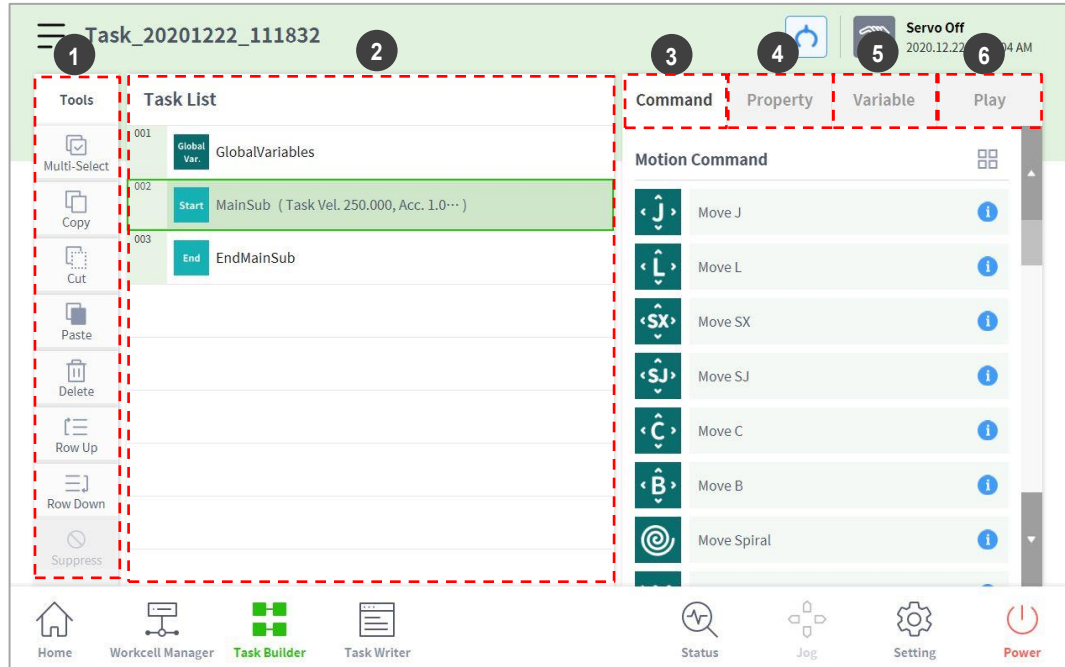

No.	Item	Description
1	Edit Command Tool (CTR)	<ul style="list-style-type: none"> • Multi Select: Select multiple commands. • Copy: Copies a command. • Cut: Cuts a command. • Paste: Pastes a copied or cut command. • Delete: Deletes a command. • Line Up: Moves a command up by a line. • Line Down: Moves a command down by a line. • Annotate: Annotates a command to exclude the corresponding command from execution during task execution.
2	Task List	Displays the task order and a list of commands added from the Command tab. When a task is created, GlobalVariables , MainSub and EndMainSub commands are added automatically.
3	Command	Displays a list of commands to add to the Task List. Selecting a command will add it to the Task List.
4	Property	Check and edit the settings of the command added to the task list.
5	Variable	Adds a system variable or tracks global and system variables used in a task.
6	Play	Executes the task currently being configured in virtual/ream mode.

 **Note**

- **GlobalVariables:** The global variable and global pose of the task program can be entered in the **Properties** tab of **GlobalVariables**, and predefined global variables and global poses can be used in the property screen of the command added in the task list.
- **MainSub** and **EndMainSub:** The command selected by the user is added to the bottom of the MainSub, and commands are executed in the order of commands located at the bottom of MainSub to commands located at the top of MainSub.
- **When monitoring is performed with a variable registered in the Variable tab, the value change frequency may be too fast to display the value on the screen.**

8.4.2 Add Command

To add a command, follow these steps:

- 1 Select the location to add a command in the Task List.
 - A command is added to the next line of the selected location.

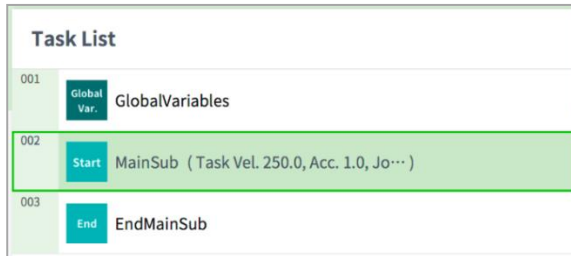

- 2 Select the command to add from the Command tab.

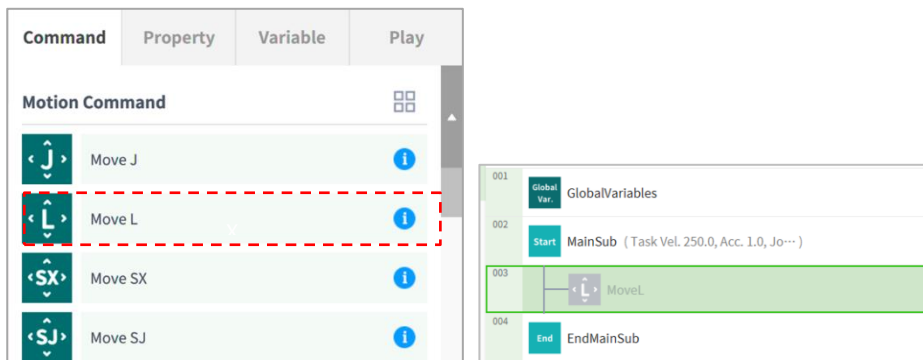

8.4.3 Delete Command

To delete a command, follow these steps:

- 1 Select a command to delete and tap the **Delete** button in the command edit tools.
- 2 When a confirmation window appears, tap the **Confirm** button.

8.4.4 Paste command

To copy/cut and paste a command to the task list, follow these steps:

- 1 Select command to copy or cut.
- 2 Tap the **Copy** or **Cut** button on the command edit tool.
- 3 Select the location to paste the command.
 - The copied/cut command is added to the next line of the selected location.
- 4 Tap the **Paste** button on the command edit tool.

8.5 Setting and Applying Command Properties

Tap a command list added to the task list to configure the properties of the command.

- The properties to configure vary according to the command.
- Some buttons in the command properties are enabled when related properties are entered.
- For user convenience, some properties are preconfigured with default values.
- If necessary, comments for the command can be entered.

Command	Property	Variable	Play
Move L (Linear)			Confirm
<input type="text" value="Enter annotation"/>			

- The properties of a command are applied only after the **Confirm** button is tapped.

Command	Property	Variable	Play
Move L (Linear)			Confirm
<input type="text" value="Enter annotation"/>			

For more information about command properties, refer to the Reference Manual provided separately.

8.6 Motion Command Property Setting

8.6.1 Waypoint Setting

To configure the waypoint of a command, follow these steps:

- 1 Select the type (**Absolute**, **Relative**) of reference coordinate and coordinate value.



The screenshot shows a control panel for setting the coordinate type. At the top, there is a dropdown menu labeled "Coordinate" with "BASE" selected. Below this, there are two buttons: "Absolute" (highlighted in blue) and "Relative" (light gray).

- 2 Either use the jog function or perform direct teaching to move the robot to the desired position.
- 3 Tap the **Save Pose** button to save the robot tool position.
 - If necessary, define a variable using GlobalVariables or the Define command.

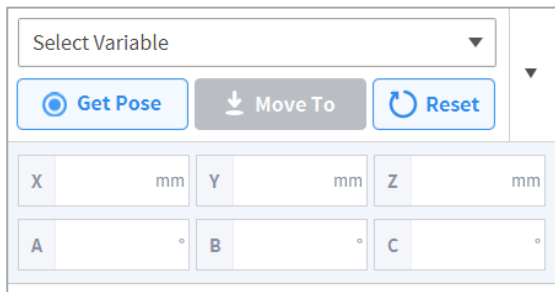

The screenshot shows a pose configuration interface. At the top, there is a dropdown menu labeled "Select Variable". Below it are three buttons: "Get Pose" (with a target icon), "Move To" (with a downward arrow icon), and "Reset" (with a circular arrow icon). Below the buttons are six input fields arranged in two rows and three columns. The first row contains fields for X (mm), Y (mm), and Z (mm). The second row contains fields for A (°), B (°), and C (°).

8.6.2 Speed Setting

The default speed is the speed configured for all areas. If the speed property is set as **All Areas**, it operates with the speed set in the **MainSub** property.

The screenshot shows a control panel for speed settings. At the top, there are three tabs: 'Speed', 'Global', 'Local', and 'Time'. The 'Global' tab is currently selected. Below the tabs, there is a section titled 'Transitional'. Under this section, there are two main settings: 'Velocity' and 'Acceleration'. Each setting consists of a dropdown menu labeled 'Select Variable', a horizontal slider bar, and a numerical input field. For 'Velocity', the slider ranges from 0.00 mm/s to 2,000.00 mm/s, and the input field shows 250.00. For 'Acceleration', the slider ranges from 0.00 m/s² to 100.00 m/s², and the input field shows 1.00.

Tap the "**Local**" tab and set the velocity property to **Local** to designate the velocity to be applied to the command individually.

- The user can enter a speed and acceleration directly or use the slide bar to setting.
- The user can configure variables if necessary.



Caution

- If a heavy (15 kg or more) tool is attached, it is recommended to set the acceleration value to the same amount or less. (Speed:Acceleration Ratio = 1:1)
- If a high acceleration is set, the robot may vibrate during acceleration/deceleration.

8.6.3 Program Link Mode Setting

Execute the following lines simultaneously with the motion to control the flow of the program.

- **Synchronized:** Program flow is put on hold until the motion ends.
- **Asynchronized:** This executes the following line simultaneously with the motion. This can be utilized for tasks such as verifying external signals or delivering output during motion.

Operating mode Sync Async

8.6.4 Blending Mode Setting

This is a function to move smoothly to the next target point if a specific condition is satisfied without stopping when the target point (waypoint) of the current motion command is reached.

Blending mode Duplicate Override

If the radius is set to 0, the motion blending function does not activate. So, if the robot reaches the target point of the current command, it stops and then moves to the target point of the next motion command.

Radius

0.00 mm 1000.00 mm

Overlap: When the robot reaches the set radius centering the target point of the motion command, it retains the speed of the current command and moves to the target point of the next command.

Override: When the robot reaches the set radius centering the target point of the motion command, it immediately reduces the speed of the current command and moves to the target point of the next command.

Note

- If a skill is added or TCP setting performed to the command block that follows the blending radius setting, there could be an error while executing.

8.6.5 Multi-Segment (Waypoint) Setting

Depending on the motion command, it may be necessary to configure two or more waypoints. Each waypoint is referred to as a segment, and adding a waypoint will add a line at the bottom of the command. The motion commands requiring two or more segments are referred to as “multi-segment motion commands.”

The following is an example of configuring a Move SJ command.

- 1 Tap **Add Pose** in command properties.
 - Segment 1 is added to the bottom line of Move SJ command.

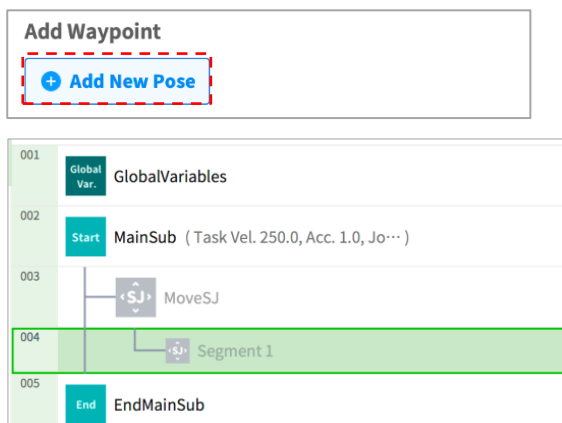

- 2 Either use the jog function or perform direct teaching to move the tool to the desired position.
- 3 Tap the **Save Pose** button in segment properties to save the robot tool position.
- 4 Repeat steps 1-3 to add segments.

8.7 Skill Command Property Setting

8.7.1 Understanding Basic Principles of Skill Commands

Skill commands are based on a few operation patterns.

For a robot to begin operation, the weight and tool center point (TCP) of the tool equipped on the robot must be configured, and the basic operation pattern of a skill command is to have an approach pose that is perpendicular to the action pose.

TCP Setting: Using an End Effector skill command will automatically change the TCP offset setting. The End Effector skill command execution stage includes an offset setting suited for the TCP of the End Effector. If the TCP offset changes, the Blending Motion function, which smoothly connects the previous motion command, cannot be used.

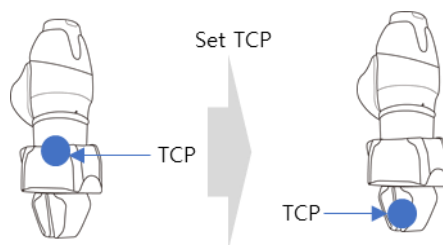

Move to Approach Pose: This is a point available to move to the Approach Pose. It is set in the -Z direction from the Approach Pose, and a different direction can also be selected. The Approach Distance entered is automatically calculated for the Action Pose and moves to the corresponding point.

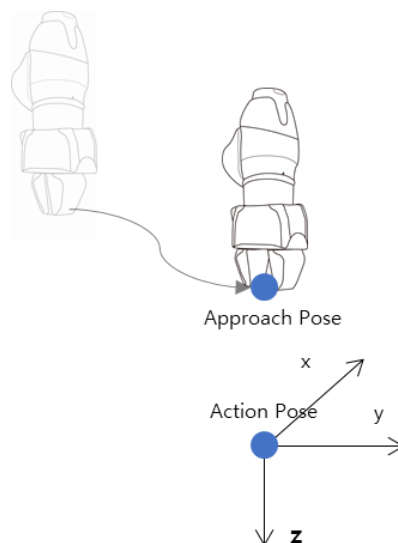

Move to Action Pose: This is the point on the workpiece where the End Effector performs work. (e.g., *Picking Pose*, *Placing Pose*)

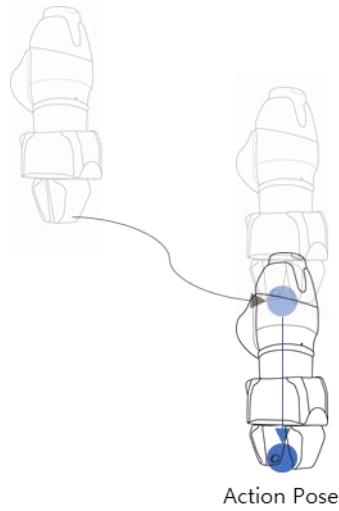

Move to Retract Pose: This is the point to pick up the workpiece and move it safely to another point. It is the -Z direction from the Approach Pose, and a different direction can also be selected. The Retract Distance entered is automatically calculated for the Action Pose and moves to the corresponding point.

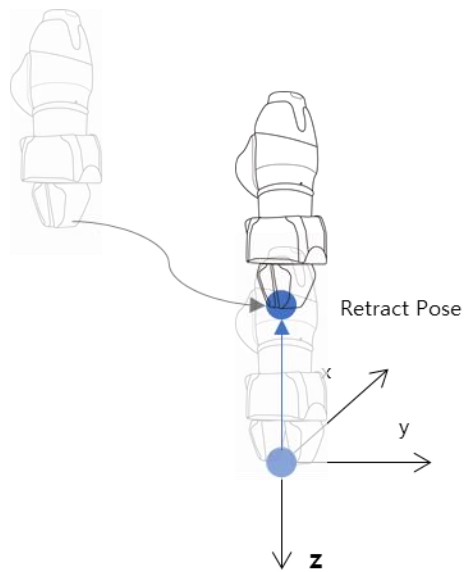

Move to Action Start Pose: If the End Effector execution target does not end with a single motion, there may be an intermediate point and an end point, and the Action Start Pose is the point where the work starts. (e.g., *Door Open Skill* - *Start Pose*, *Screw Drive Skill* – *Start Pose*)

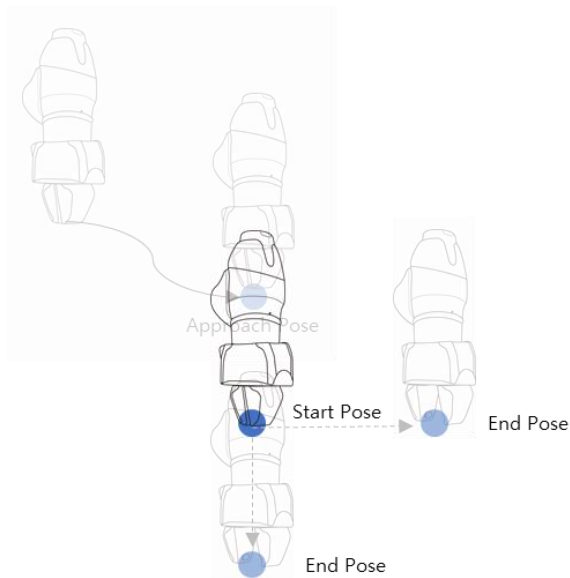

Move to Action End Pose: If the End Effector execution target does not end with a single motion, there may be an intermediate point and an end point, and the Action End Pose is the point where the work ends. (e.g., *Door Open Skill* – *End Pose*, *Screw Drive Skill* – *End Pose*)

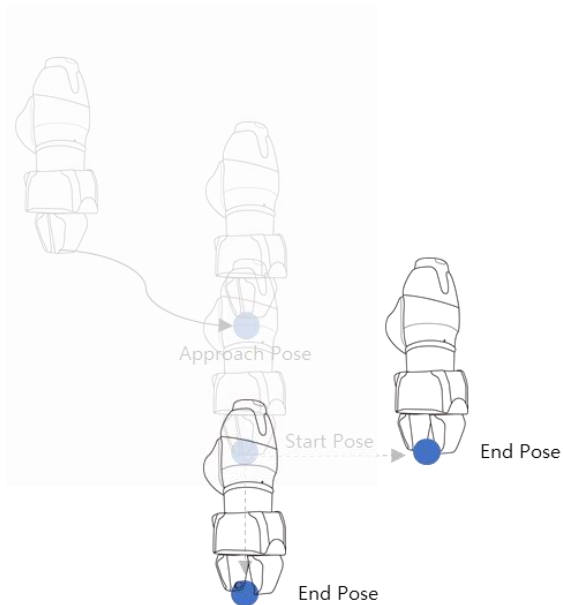

8.7.2 Compliance Control and Contact Check

With the Compliance Control and Contact Check functions, which is the unique force control technology of Doosan Robotics, it is possible to easily perform teaching without repeated operation for accurate point designation since it allows position deviation within a tolerance range between the workpiece and surrounding items during robot operation.

Compliance Control: If force is applied during Approach →, Action → and Retract, it allows deviation from the set position with some level of buffering, like a spring.

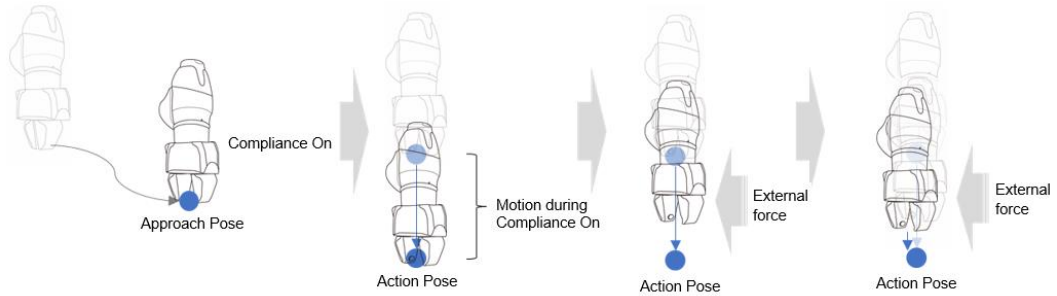

Contact Check: Based on the **Contact Force** and **Contact Determination Range** values entered, the function detects contact with the target, stops at a corresponding position and activates the gripper to grab the target.

- This function must be used with Compliance Control Function. If **Force** is entered and Compliance Control is not enabled, an error occurs.
- Contact is a function that detects contact with an external force, so the sensitivity of Collision Detection must be set at low levels or Collision Detection must be disabled.
- Be careful when using this function, as excessive force can be generated when contacting the external environment if the Compliance Control option stiffness (i.e., Z-direction) value is too large or the work speed is too high. (It is necessary to make adjustments according to the situation by lowering the stiffness value if the work speed is too high or by increasing the stiffness if work speed is too low.)

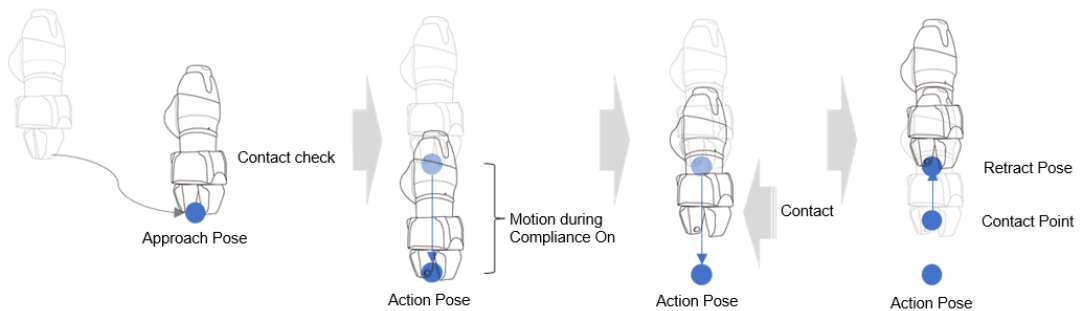

 **Note**

- If contact with a force greater than the set range occurs with Contact Check enabled, a notification window appears. To remove the obstacle and continue work, press the **Continue** button on the notification window and remove the obstacle.
- If FTS is not installed when using the A-Series, the Contact Detection function cannot be used. Also, Compliance Control can be used limitedly. Only the stiffness value of the Translation (X, Y, Z) direction can be modified.

8.7.3 Skill Command Work Point Setting with Cockpit Buttons

Cockpit buttons can be used to configure the action pose.

For example, with the Pick skill command:

- 1 Add a skill command from **Task Builder** and tap the added skill command.
- 2 Perform direct teaching to the skill's action pose to move the robot.
- 3 Press the Save Pose button on the cockpit.

 **Note**

- Save Cockpit Pose is available from the Task Builder and Task Writer.

8.8 Execute Task Program

Provides descriptions of the play screen of Task Builder and screen configuration. The play screen offers the function to priorly check robot motion by executing the task virtually.

Note



- Before closing the simulator/robot, make sure to press the "stop" button (⏹) to stop the motion program.
- Moving to the **Play** tab disengages manual mode and engages Auto mode.
- When entering manual mode on the **Play** tab, go to the **Command** tab or **Properties** tab before moving to another menu.

8.8.1 Virtual mode screen

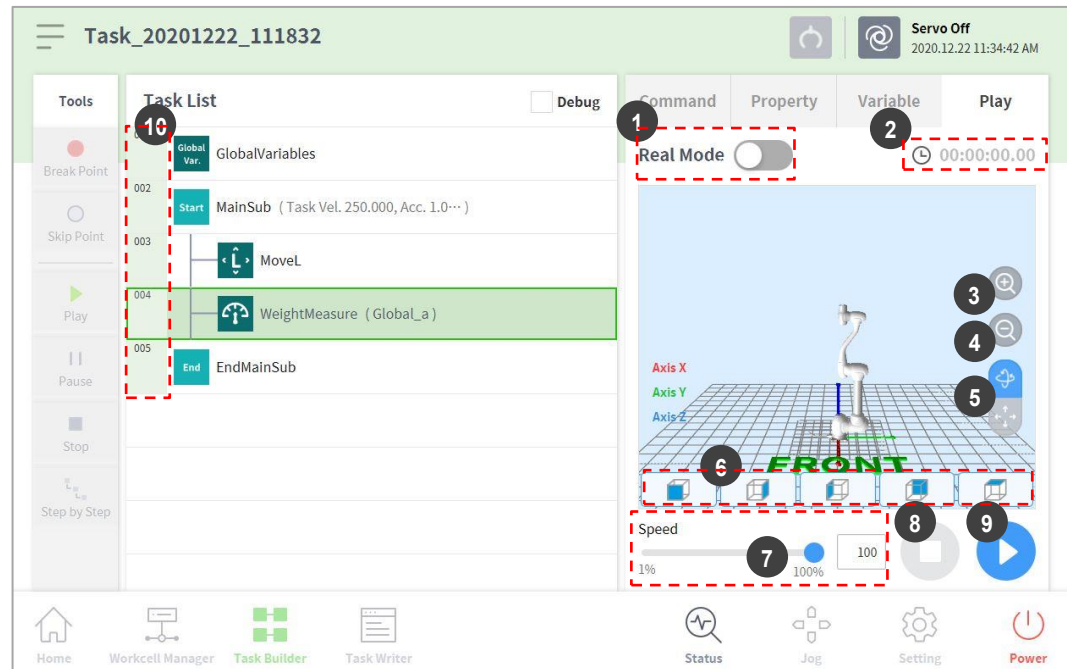
The virtual mode screen of Task Builder is structured as follows:



No.	Item	Description
1	Real mode ()	Sets the robot test play mode. <ul style="list-style-type: none"> • Real mode: Operates an actual robot to test the task in the task list. • Virtual mode: Uses a simulator screen to test the task in the task list.
2	Total time	Displays the total time elapsed after the task execution.
3	Simulator Zoom-in button	Zooms into the simulated robot model.

No.	Item	Description
4	Simulator Zoom-out button	Zooms out from the simulated robot model.
5	Rotate and pan button	Rotate button  : Rotates the simulation screen with the robot base as a central axis. Pan button  : Moves the simulation screen horizontally and vertically.
6	Viewpoint button	Sets viewpoints with the robot model as the control point.
7	Speed slider	It sets the speed of the robot in a real or a virtual mode.
8	Stop button	It stops the current task.
9	Execute/pause toggle button	It executes or pauses the work in the task list.
10	Time	It displays the time spent on the corresponding command/skill.

8.8.2 Real Mode Screen: End Effector Information tab

The real mode screen end effector information tab of Task Builder is structured as follows:

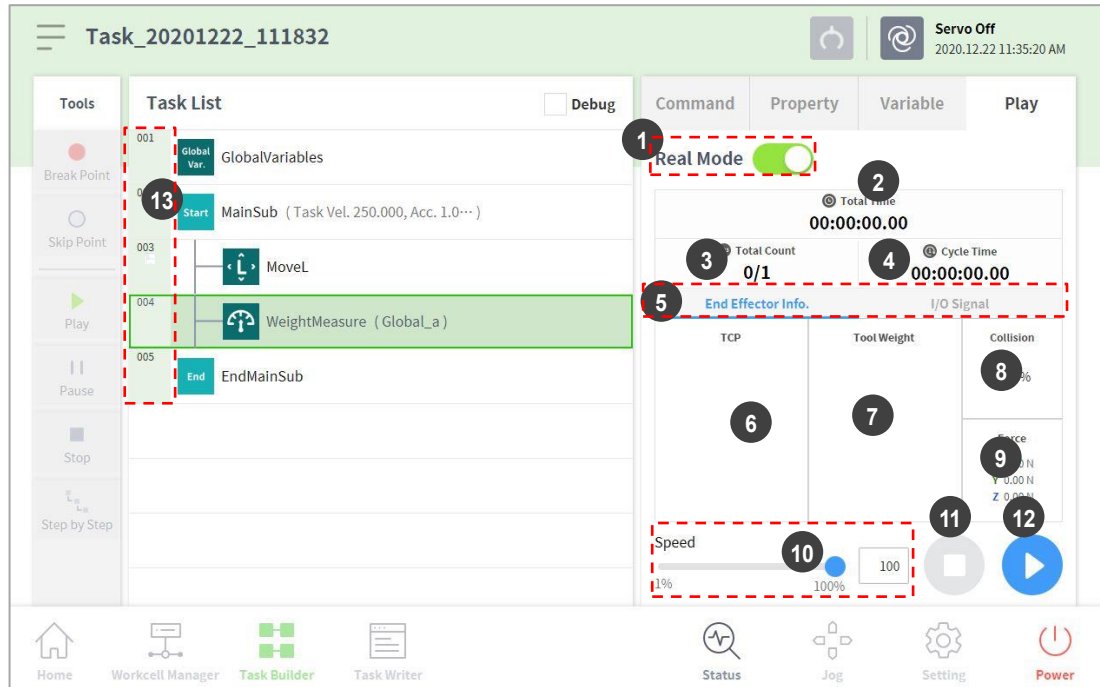

No.	Item	Description
1	Real Mode ()	Sets the robot test play mode. <ul style="list-style-type: none"> • Real mode: Operates an actual robot to test the task in the task list. • Virtual mode: Uses a simulator screen to test the task in the task list.
2	Total time	Displays the total time elapsed after the task execution.
3	Total count	Displays the total number of task executions.
4	Average execution time	Displays the average time spent to execute one cycle of the task in the task list.
5	Information Screen Shift Tab	Shifts between the information screen of the robot end effector and the I/O information screen. <ul style="list-style-type: none"> • End Effector Information Tab: Displays the center point of the robot tool, the tool weight and the collision and force information. • I/O Information Tab: Displays the I/O information of the controller and the flange.
6	Tool center point information area	Displays the tool center point information configured through the tool center point and weight configuration functions of the set TCP command or the jog.

No.	Item	Description
7	Tool weight information	Displays the tool weight information configured through the tool center point and weight configuration functions of the set TCP command or the jog.
8	Collision information area	Displays the collision sensitivity value set for the area where the robot is currently positioned.
9	Force information area	Displays the force information according to the tool direction.
10	Speed slider	It sets the speed of the robot in a real or a virtual mode.
11	Stop button	It stops the current task.
12	Execute/pause toggle button	It executes or pauses the work in the task list.
13	Time	It displays the time spent on the corresponding command/skill.



Caution

- Before executing a task, execute the task in virtual mode to check whether the task operates as intended.
- It is recommended to test the robot program by designating temporary waypoints outside another machine's work space. Doosan Robotics is not responsible for damages that occur due to programming error or robot malfunctioning, as well as damage to the equipment.
- The emergency stop button is located on the teach pendant. In an emergency situation, press the emergency stop button to stop the robot.

Version A Series

In the case of models without Force Torque Sensor, the force (X, Y, Z) values are not monitored.

8.8.3 Real Mode Screen: I/O Information Tab

The real mode play screen end I/O information tab of Task Builder is structured as follows:

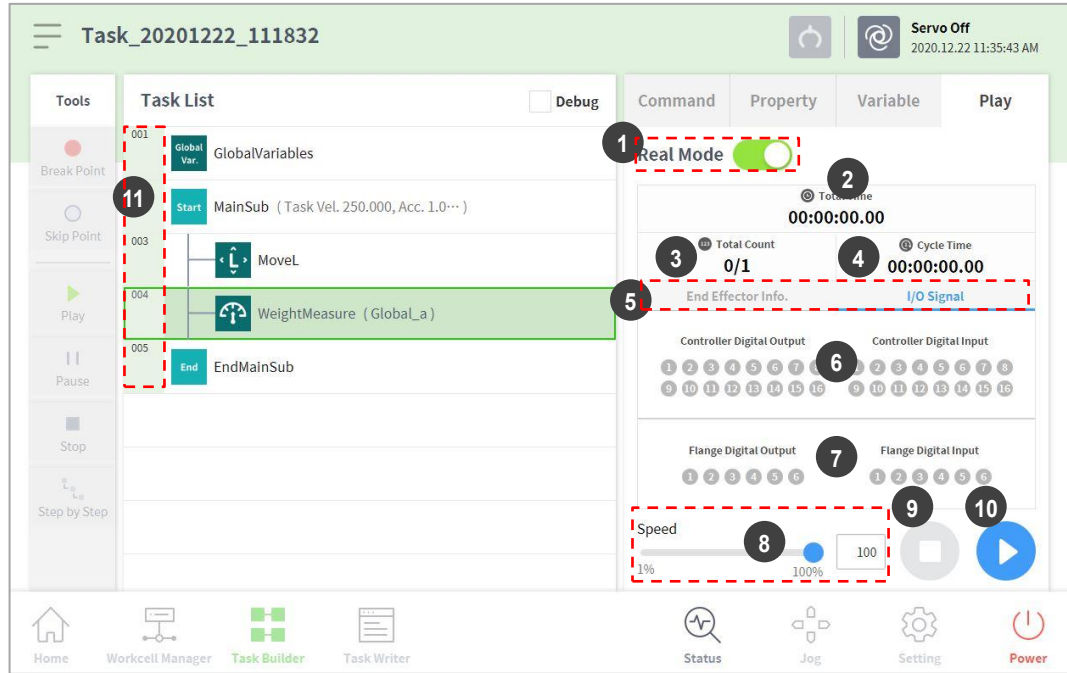

No.	Item	Description
1	Real mode ()	Sets the robot test play mode. <ul style="list-style-type: none"> • Real mode: Operates an actual robot to test the task in the task list. • Virtual mode: Uses a simulator screen to test the task in the task list.
2	Total time	Displays the total time elapsed after the task execution.
3	Total count	Displays the total number of task executions.
4	Average execution time	Displays the average time spent to execute one cycle of the task in the task list.
5	Information Screen Shift Tab	Shifts between the information screen of the robot end effector and the I/O information screen. <ul style="list-style-type: none"> • End Effector Information Tab: Displays the center point of the robot tool, the tool weight and the collision and force information. • I/O Information Tab: Displays the I/O information of the controller and the flange.
6	Controller digital I/O signal	Displays the controller digital I/O signals of the current task. <ul style="list-style-type: none"> • If the digital signal is a high signal, the icon is displayed in sky blue. • If the digital signal is a low signal, the icon is displayed in gray.

No.	Item	Description
7	Flange digital I/O signal	Displays the flange digital I/O signals of the current task. <ul style="list-style-type: none"> • If the digital signal is a high signal, the icon is displayed in sky blue. • If the digital signal is a low signal, the icon is displayed in gray.
8	Speed slider	It sets the speed of the robot in a real or a virtual mode.
9	Stop button	It stops the current task.
10	Execute/pause toggle button	It executes or pauses the work in the task list.
11	Time	It displays the time spent on the corresponding command/skill.

Version A Series



- I/O information screen in A-Series only monitors 2 flange I/Os.

8.8.4 Execute Task

It is possible to test the task being created by executing it. To execute a task, follow these steps:

- 1 Select the **Play** tab.



- 2 Tap the **Real Mode** () button.
- 3 Drag the speed slider to set the robot speed.
- 4 Press  to execute the task.
 - Pause (): Pauses the task currently being executed.
 - Stop (): Stops the task currently being executed.

Note

- If Real mode is off, execution is made only in virtual mode where the robot is only operated in the simulator.
- When Real mode is turned on, a status display showing the I/O status appears.
- When executing a task program in virtual mode, it is only executed once regardless of the setting, and diverging through I/O signal within the task does not execute properly.
- Tool center position and tool weight information on the play information screen are only displayed properly when the Set TCP command is executed or the tool center position and weight of the jog are set.
- Commands that had issues occur during program execution are highlighted with orange.

9. Task Writer

Task Writer is intended for advanced users familiar with program coding. It allows complex motions that cannot be executed with basic commands to be created using DRL (Doosan Robot Language) and Custom Code, which allows the user to load and execute programs created or saved on an external storage device.

Simplified, convenient functions are only available in **Task Builder**, and advanced custom code functions are only available with the **Task Writer**.

Tap the Task Writer () button to go to the Task Writer screen.

9.1 Task Management

9.1.1 Create New Task

To create a new task, follow these steps:

- 1** Tap "**New**" on the main Task Writer screen.
 - If a task is being edited, tap the  Menu button and tap **New**.
- 2** Enter the name of the new task program in the **File Name** field.
- 3** Tap the **Confirm** button.

When a new task is created, the task edit screen is displayed. For more information on how to edit a task, refer to "**8.4 Edit Task**".

9.1.2 Save Task

To save an edited task, tap the  Menu button and tap **Save**.

Note

If the file is not saved for the first time, a confirmation window appears. Tap the **Confirm** button to save it to an existing file.

9.1.3 Save Task As

To save a task as different file, follow these steps:

- 1 Tap the  "Menu" button and tap the **"Save as"** button.
- 2 When the **Save as** window appears, enter the task name and tap the **Confirm** button.

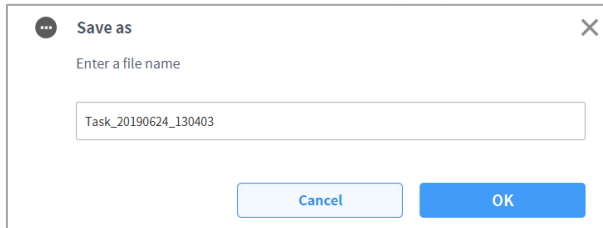

When the save is complete, the **Save Complete** window appears.

9.1.4 Save Task on External Storage Device

To save an opened task as on an external storage device, follow these steps:

- 1 Connect an external storage device to the USB slot.
 - Only external storage devices with FAT32 file systems can be used.
- 2 Tap the  Menu button and tap **Export**.
- 3 After the **Export** window appears, select the drive of the external storage device and tap the **Confirm** button.
- 4 When the **Save as** window appears, enter the task name and tap the **Confirm** button.

When the save is complete, the **Save Complete** window appears.

Note

The file extension of the saved task file is “tw”.

9.1.5 Load Saved Tasks

To load a saved task, follow these steps:

- 1** Tap **Saved Files** on the main screen of **Task Writer**.
 - If a task is being edited, tap the  Menu button and tap **Open**.
- 2** Select a task to open from the file list and tap the **Open** button.
- 3** Searches for tasks in the file list can be made using the filter function.
 - Search in latest, oldest, alphabetical order, and reverse order is possible.

Note

Even if the model where the task was created is different, the task can be loaded on any M-Series model. However, the M-Series and A-Series are not mutually compatible.

9.1.6 Delete Saved Tasks

To delete a saved task, follow these steps:

- 1 Tap **Saved Files** on the main screen of **Task Writer**.
 - If a task is being edited, tap the  Menu button and tap **Open**.
- 2 Select a task to delete from the file list and tap the "**Delete**" button.

9.1.7 Import Tasks on External Storage Devices

To import a task saved on an external storage device, follow these steps:

- 1 Connect the external storage device with the task file to the USB slot.
- 2 Tap the **Import** on the **Task Writer** initial screen.
- 3 Tap the **Search** button.

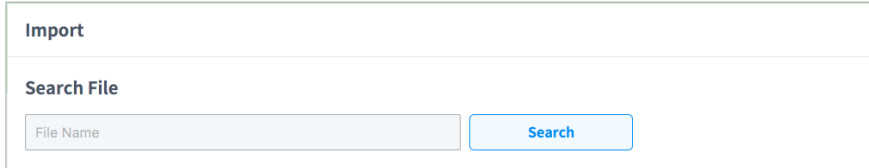

Import

Search File

File Name

Search

- 4 When the **Search File** window appears, select the task to import and tap the **Confirm** button.

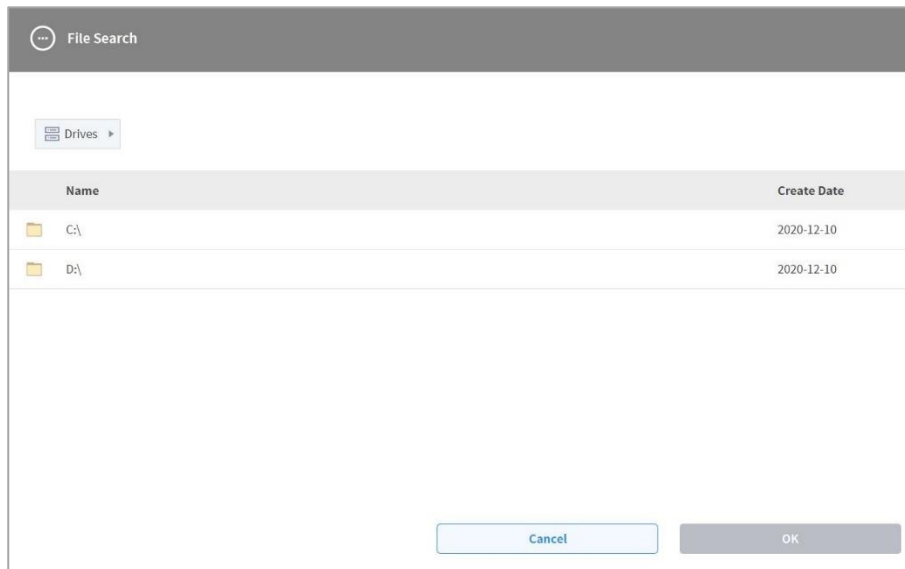

File Search

Drives

Name	Create Date
C:\	2020-12-10
D:\	2020-12-10

Cancel OK

- 5 Tap the **Import** button on the bottom right.

When the task file is saved on an external storage device, the **Save Complete** window appears.

To load a task file saved on the system, refer to “**9.1.5 Load Saved Tasks.**”

9.1.8 Export Task to External Storage Device

To export a task to an external storage device, follow these steps:

- 1 Connect the external storage device with the task file to the USB slot.
- 2 Tap the **Export** on the **Task Writer** initial screen.
- 3 The export popup window appears. Select the external drive to export the task and tap the **"Confirm"** button.

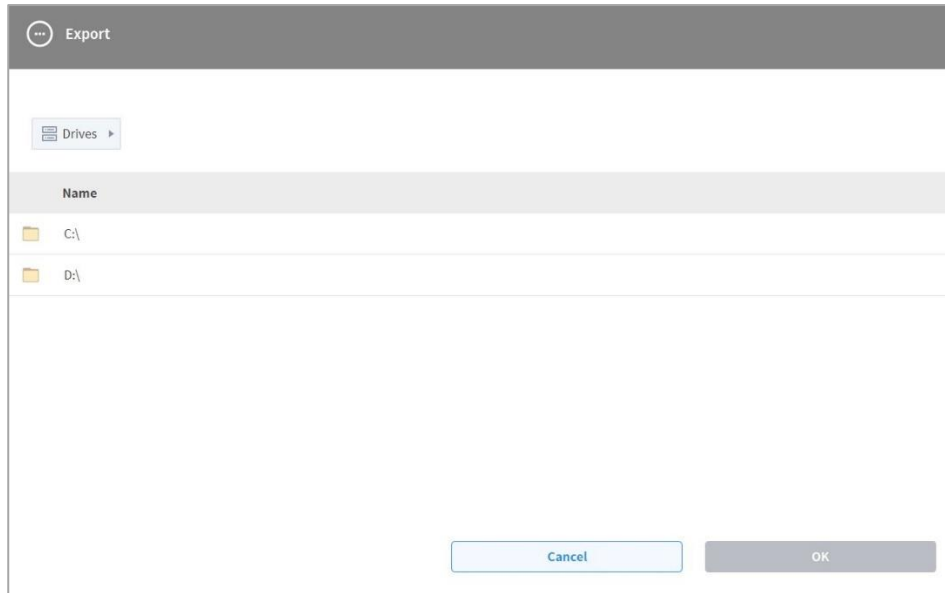

- 4 The Save As popup window appears. Enter the task name in the popup window and tap the **"Confirm"** button.

9.2 Edit Task Program

The edit screen of Task Writer is identical to that of the edit screen of Task Builder, and the editing features are also identical.

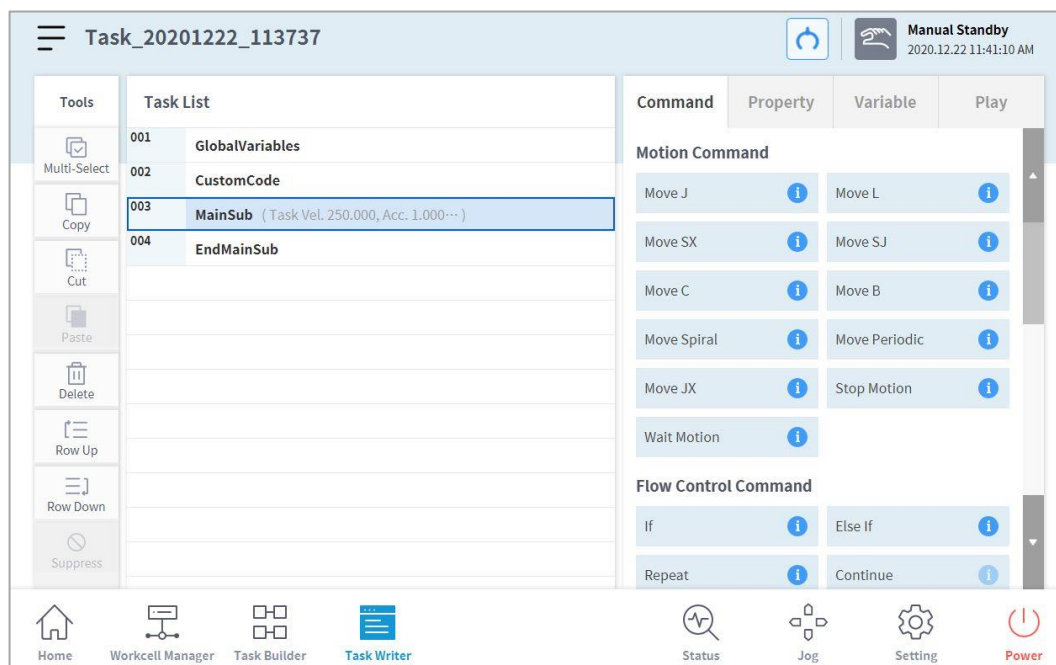

For more information about the edit task program, refer to “8.4 Edit Task”.

Note

- **GlobalVariables:** The global variable and global pose of the task program can be entered in the **Properties** tab of **GlobalVariables**, and predefined global variables and global poses can be used in the property screen of the command added in the task list. 10 all-area variables and all-area poses can be added to each GlobalVariables command.
- **CustomCode:** The user can enter DRL Codes or load predefined programs saved in an external storage device.
- **MainSub** and **EndMainSub:** The command selected by the user is added to the bottom of the **MainSub**, and commands are executed in the order of commands located at the bottom of **MainSub** to commands located at the top of **MainSub**.
- **Thread:** Jobs to be performed simultaneously with **MainSub** can be added as a **Thread**, and when a **Thread** is added, a command can be added below the **Thread**. Motion commands cannot be added to a **Thread**.

9.3 Task Writer Command

The commands available in the Task Writer are **Motion Commands**, **Flow Control and Other Commands**, and **Advanced Commands**.

- **Motion Command:** These are commands used to adjust or change the robot's pose.

Move J	Used to move the robot to the target joint coordinates.
Move L	Used to move the robot along a line towards the target work space coordinate.
Move SX	Used to move the robot along a curved line connecting multiple via points and target points within the workspace.
Move SJ	Used to move the robot along a curved line connecting multiple via points and target points expressed as a joint coordinate.
Move C	Used to move the robot along an arc composed of a current point, via point and target point.
Move B	Used to move the robot along a line and arc connecting multiple via points and target points within the workspace.
Move Spiral	Used to move the robot along a path extending to the outer side from the center of a spiral.
Move Periodic	Used to move the robot along a path repeated periodically.
Move JX	Used to move the robot to the target workspace coordinate and joint form. This does not move along a straight line.
Stop Motion	This is used to stop task execution.

- **Flow Control and Other Commands:** These can control the task flow through task standby, repeat, executing commands included in the task and conditions.

If	This is used to branch according to a specific condition during task execution.
Else If	This is used to branch according to a specific condition during task execution.
Repeat	This is used to repeat the task command.
Continue	This is used to return to the first command of a repetition statement (Repeat).
Break	This is used to exit the repeat execution command (Repeat).
Exit	This is used to end task execution.
Sub	This is used to define a subroutine within the task.

If	This is used to branch according to a specific condition during task execution.
Call Sub	This is used to execute the defined subroutine.
Thread	This is used to define a thread within the task.
Run Thread	This is used to execute the defined thread.
Kill Thread	This is used to end thread execution.
Sub Task	This is a command to define a thread within the task.
Call Sub Task	This is a command to execute a defined subtask.
Wait	This is used to temporarily stop task execution.
User Input	This is used to receive user input and save it in a variable during task execution.
Watch Smart Pendant	This is used to control the Function button.

- **Force Control Command:** The force of the robot can be controlled during task execution.

Compliance	This is used to control Compliance during task execution.
Force	This is used to control force during task execution.

- **Other Commands:** There are commands that weigh the item and receive user input.

Comment	This is used to save the user-designated information in a log during task execution.
Custom Code	This is used to insert and execute a DRL code during task execution.
Define	This is used to define a variable during task execution.
Popup	This is used to display a popup screen during task execution.
Set	This is used to execute various settings during task execution.
Weight Measure	This is used to measure the weight during task execution and save it in a variable.
Wait Motion	This is used to temporarily stop the robot after the previous motion command is complete.
GlobalVariables	This is used to add a Global Variable.

- **Advanced Commands:** There is a command to execute Hand-guiding.

Hand Guide	This is used to execute direct teaching during task execution.
Nudge	This is used to delay task execution until Nudge (applying force to the robot) input.

Version A Series

- In models without Force Torque Sensors, Rx, Ry and Rz values of **Weight Measure**, **Nudge**, **Compliance** commands, and A, B and C values of **Force** command are not supported.
- The **Watch Smart Pendant** command provides functions to control conditions using the Function button of the Smart Pendant

9.4 Setting and Applying Command Properties

Configuring and applying the commands in **Task Writer** are identical to those of **Task Builder**.

9.5 Execute Task Program

The execution of task programs in **Task Writer** is identical to that of **Task Builder**.

9.6 Debug Screen

The debug mode of the Task Writer screen is structured as follows:

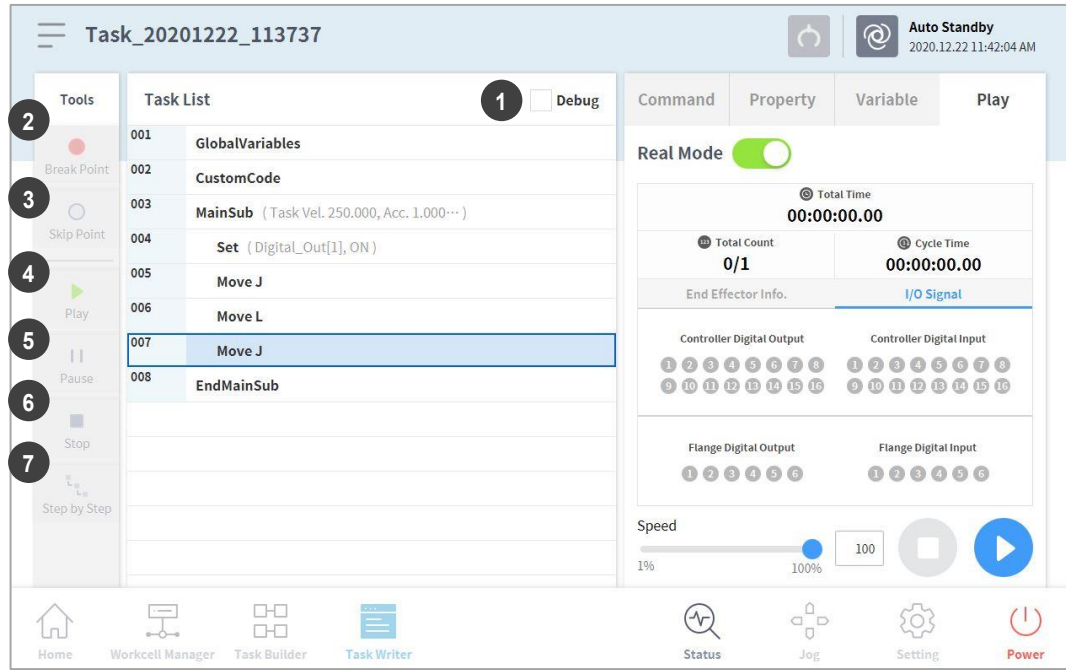

No.	Item	Description
1	Debug	Sets the robot test play debug mode.
2	Break Point Button	Sets a break point in a command. When the command is reached after executing the task, the robot does not execute the task and stops.
3	Skip Point Button	Sets a skip point in a command. When the command is reached after executing the task, the robot does not execute the task.
4	Play/Restart Toggle Button	Executes the task in debug mode. If the break point is reached during task execution or if the task is paused, the button changes to the Restart button.
5	Pause Button	Temporarily pauses the current task execution.
6	Stop button	Suspends the current task.
7	Stage by Stage	Executes one command at a time while the task is paused.

10. Monitoring and Testing

To check or test the I/O information, tap the **Status** button in the main menu.

The **Status** window allows you to check the I/O information of devices connected to the controller and flange, and the **Backdrive** mode and **Safety Recovery** function can be executed.

The **Status** window is a popup window, so it is possible to tap the **Status** button on the **Home**, **Task Builder** or **Task Writer** screen even during Auto mode to check I/O information. The output test cannot be performed during Auto mode.

10.1 Screen Layout

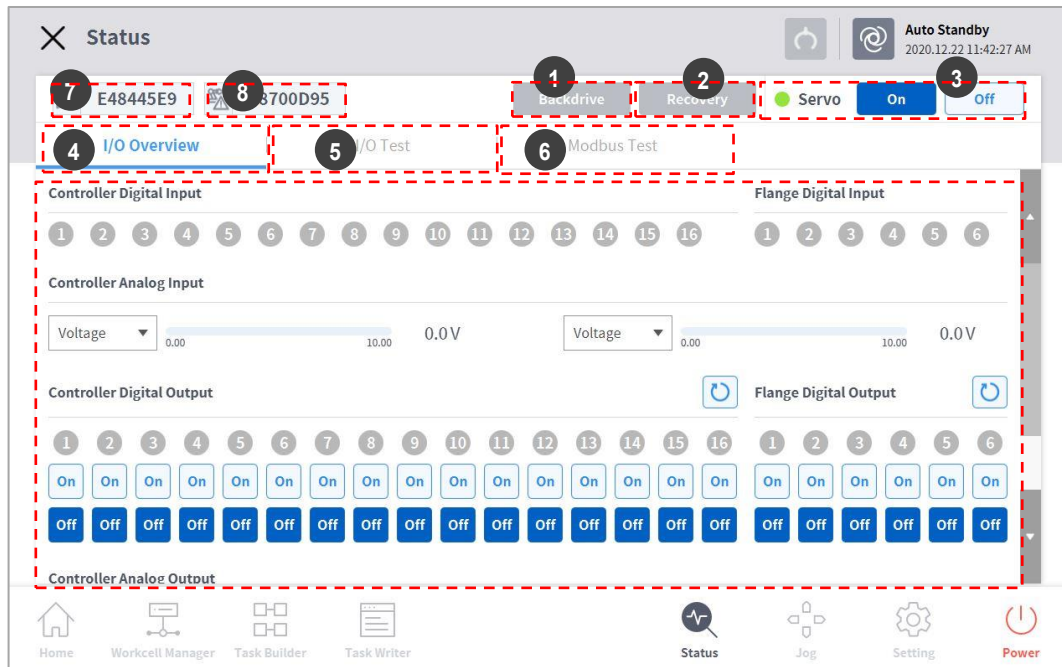

No.	Item	Description
1	Backdrive	If the robot is stopped due to an abnormality during operation, the user can cut the power to each joint and move the joint to the desired position manually to recover the normal operation status.
2	Safety Recovery	Sets the robot angle and position when setting the robot in software recovery mode and packaging mode.
3	Servo On	Supplies the driving power that moves each joint of the robot.
4	I/O	Manages the digital and analog I/O status of the controller and flange.

No.	Item	Description
5	I/O Test	Checks and tests the digital and analog I/O devices of the controller and flange used by the task.
6	Modbus Test	Tests the signals of the set Modbus device.
7	Job Space Status Value	Displays encryption of the entire job space data registered to check whether the job space setup has been modified.
8	Safety Setup Status Value	Displays encryption of the entire safety data registered to check whether the safety setup has been modified.

10.2 I/O Status Check

10.2.1 Controller/Flange Digital Input Check



- 1 Check the port number of the device connected to the controller or flange.
- 2 The following is displayed depending on the digital input status of the corresponding number.
 - If the digital signal is a high signal, the icon is displayed in light green.
 - If the digital signal is a low signal, the icon is displayed in gray.

Note

If the digital signal is High even when the digital input is set as the safety input, the icon is displayed in blue, and if it is Low, it is displayed in gray.

Version A Series

- Only two flange I/Os of the flange digital input of A-Series are displayed.



10.2.2 Controller Analog Input Check



- 1 Press the drop-down list of the analog input of the controller to select the item to check.
- 2 Check the analog input information of the selected item displayed on the screen.

 **Note**

The analog input value cannot set the input value in the status window.

10.2.3 Controller/Flange Digital Output Setting

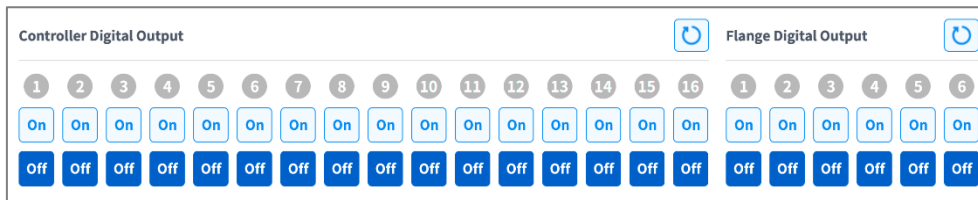

- 1 Check the port number of the device connected to the controller or flange.
- 2 Press the On/Off icon corresponding to the port number to activate or deactivate digital output.
 - The icon changes to light green and the corresponding port is enabled when the **On** icon is pressed.
 - The icon changes to light green and the corresponding port is disabled when the **Off** icon is pressed.

Version A Series

- Only two flange I/Os of the flange digital output of A-Series are displayed.



10.2.4 Controller Analog Output Setting



- 1** Press the drop-down list of the analog output of the controller to select the item to set.
 - Analog output information of the selected item is displayed on the right side of the drop-down list.
 - The default value for analog output signals is voltage.
- 2** Modify the analog output value.

10.3 I/O Test

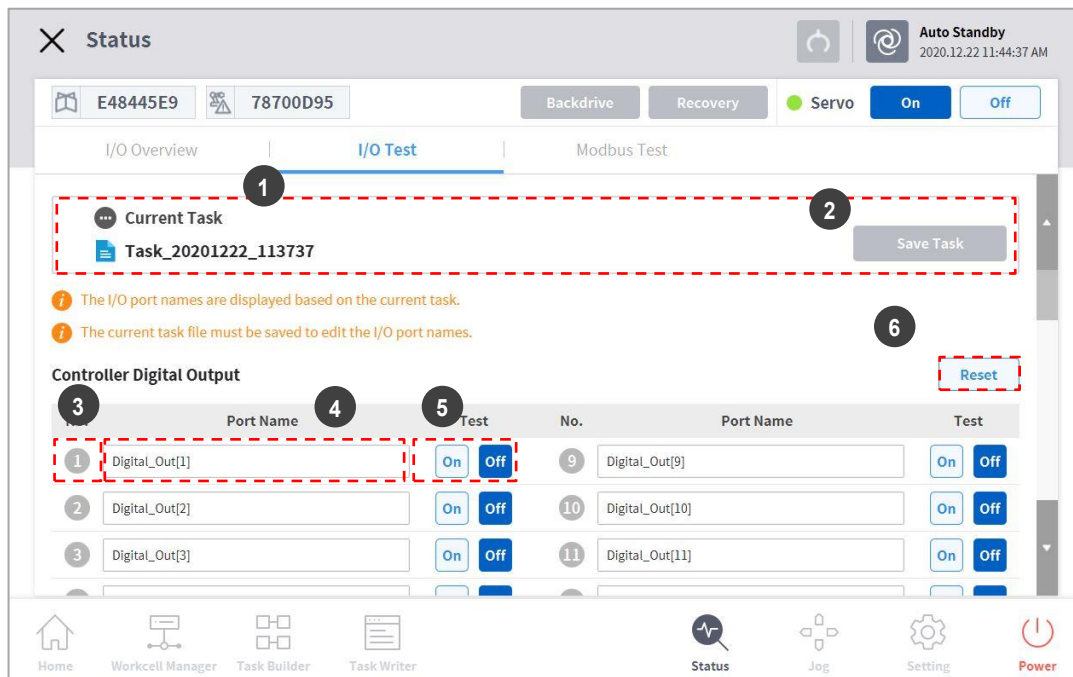

No.	Item	Description
1	Current Task	Displays the task currently being edited or executed.
2	Save Task	If changes are made to the task being edited, they must be saved in order to test the I/O device.
3	Port Number	It displays the port number used for testing the I/O device, and it is displayed when the signal is on.
4	Port Name	The port name of the I/O device for testing can be designated.
5	I/O Test	A signal can be sent to the corresponding port.
6	Initialization	Initializes all signals of the device as off.

10.4 Modbus Test

This is the menu to check and test Modbus signals set at Modbus TCP, Modbus RTU, and predefined Modbus.

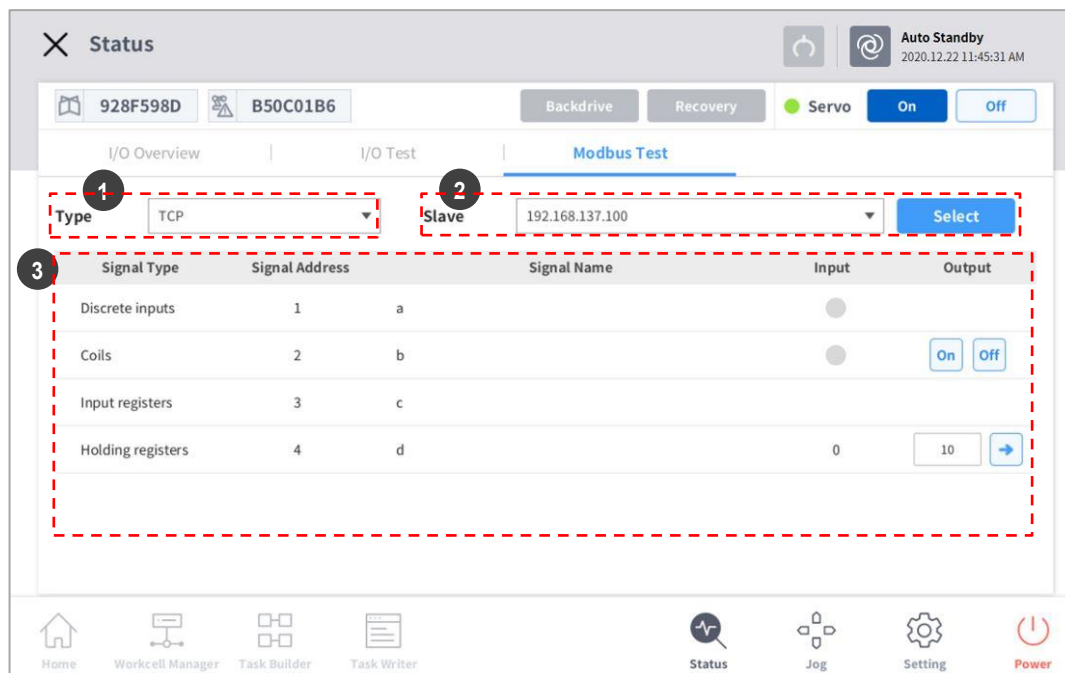

No.	Item	Description
1	Modbus Type	Select the Modbus type to check. TCP, RTU, and predefined Modbus are available.
2	Slave	Displays the list of IPs/Ports of the slave set of the selected Modbus type. When selected, it displays a list of corresponding signals.
3	Signal List	Displays a list of signals set on the selected slave. Input and output signals can be checked.

10.5 Servo On

Servo On refers to the standby status where the robot arm can be operated by supplying power to joints. Pressing the emergency stop button or violating critical safety limits sets the Servo Off status. During servo off status, the power to joints is cut off, which results in the robot arm being unable to be operated, and **Workcell Manager**, **Task Builder**, **Task Writer** and **Jog**, which are related to robot arm operation, are disabled in the main menu.

To change from Servo Off to Servo On, tap the **Status** button on the main menu and tap the **Servo On** button on the top right.

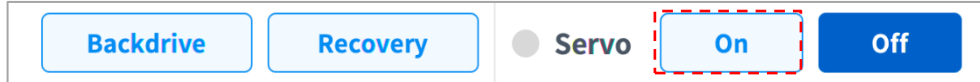

To shift from **Servo On** to **Servo Off**, tap the Status button of the main menu and tap the **Servo Off** button in the top right corner of the screen.



Note

In the **Settings** screen, if the safety signal I/O, POS_3_ENABLE_SWITCH, is set, **Servo On** is available only if this signal is inputted.

10.6 Backdrive Mode

Backdrive allows the robot joint control with only the brake and without power driving the motor. This function is used when the robot cannot return to normal with **Safety Recovery** mode or Hand-guiding. With **Backdrive** mode, the user can engage or disengage the brake of each joint.

The process of setting **Backdrive** mode is as follows:

- 1 Tap the **Status** button on the main menu and tap the **Backdrive** button.
 - If the **Backdrive** button is not enabled, press and release the Emergency Stop button or press the **Servo Off** button to enable it.

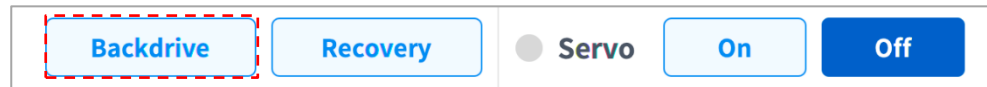

- 2 Tap the **Start Backdrive Mode** button on the **Backdrive** screen.
 - OFF/ON buttons to release the brakes of each joint are enabled.



- 3 Set the brake of the joint to move as OFF (Release) and move the robot by applying force.
 - Due to the deceleration ratio of the decelerator inside the joint, the joint sagging speed due to the manipulator weight is not high, and movement speed when force is applied is also not high.
 - If the decelerator malfunctions or if joints move at a speed faster than a certain speed during **Backdrive** mode, the brakes of all joints are applied automatically to ensure safety.
- 4 Set the brake ON (Hold) when the position change is complete.
- 5 Tap the **Power** on the main menu to shut down the operating program, tap and hold the power button on the top of the teach pendant to shut down the system, and press it again to turn on the system.
 - **Backdrive** is released and work can resume normally.

Note

- Move each joint back to the normal work range individually in sequential order.
- If **Backdrive** mode is executed, the system must be rebooted to resume normal work again.
- Use caution as temporary sagging may occur depending on the axis location in **Backdrive** mode.

10.7 Safety Recovery Mode

If there is an error with a continuing safety violation or if a robot needs to be packed for transportation, the user can use the **Safety Recovery** Mode to configure the position and angle of the robot.

- **Software Recovery:** In Servo Off status, if a safety violation error situation caused by position-related safety violations, such as the robot exiting the operation area or violating prohibited areas, occurs or force is continuously applied when the robot is stopped due to colliding with a fixed object, **Servo On** or **Jog** cannot be set even when attempting to reset the robot to a normal state using the **Jog** or program. In such cases, **Software Recovery** mode is used to reset the robot to normal.
- **Packaging Mode:** For packaging and transporting the robot, the robot can be set to predefined values (which go beyond the normal operation angle limit) for packaging.

10.7.1 Using Software Recovery Mode

To use the software recovery mode, follow these steps:

- 1 Tap the **Safety Recovery** button in the **Status** window.



- 2 Tap each joint button on the right side of the Software Recovery screen, and use **+** and **-** button to set the position. Or press the **1**, **2** and **3** buttons of the **Cockpit** to adjust the joint angle by direct teaching.
 - For more information about the cockpit buttons, refer to “**4.2.2 Cockpit Button (five buttons)**” or “**4.2.3 Cockpit Button (six buttons)**”
 - Changes made to the setting are reflected on the simulation window on the left in real time.

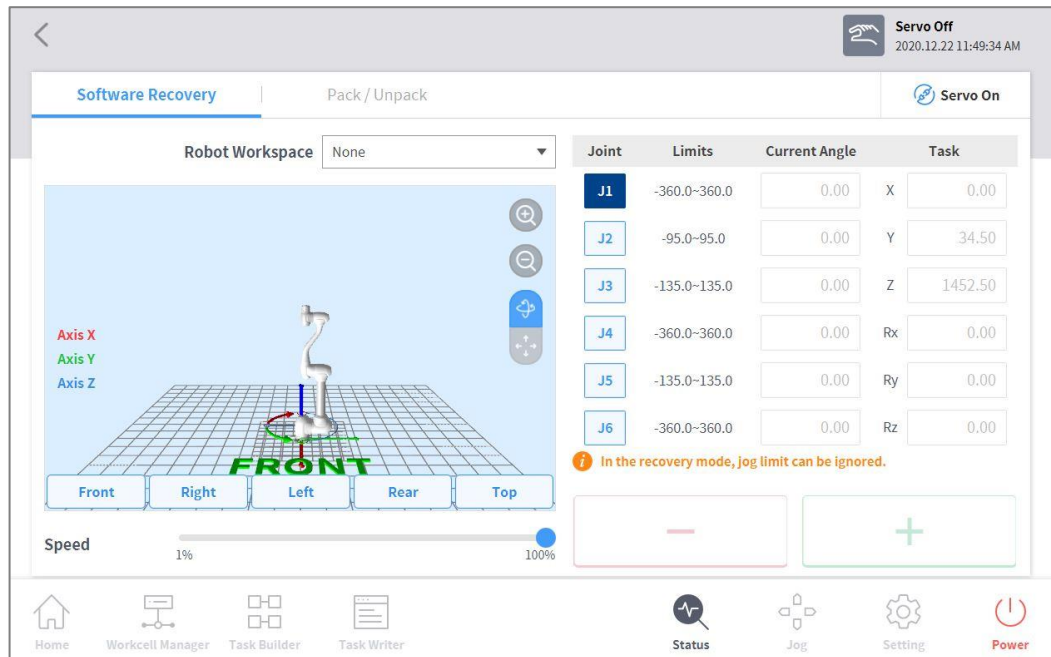

- 3 When the setting is complete, tap the X button on the top left.

10.7.2 Packaging Mode Setting

To configure the packaging mode, follow these steps:

- 1 Tap the **Safety Recovery** button in the **Status** window.



- 2 Select the **Packaging Mode** tab.

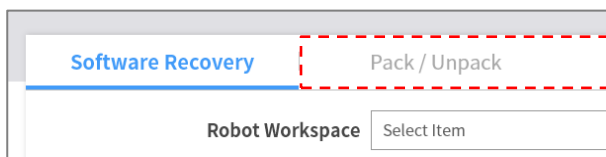

- 3 Tap the **Packaging Mode** toggle button to enable Packaging Mode.



- 4 Tap the **Go to Packaging Pose** button.

- The robot automatically moves to the set packaging pose.
- To release the packaging pose, tap the **Release Packaging Pose** button to move the robot to home position, then tap the **Packaging Mode** toggle button to disable packaging mode.

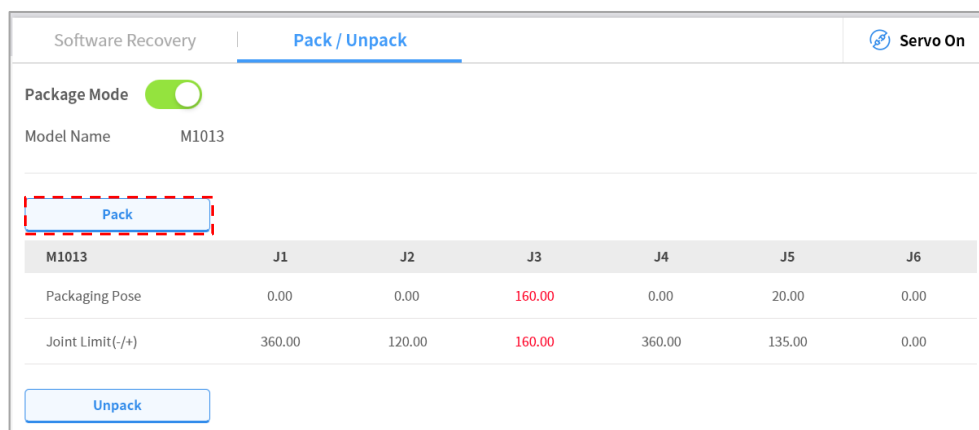

11. Jog Function

In **Jog** mode, the user can navigate the entire work space or set the operation space the user configured as the robot operation space. The movement angle of each axis can be limited according to the selected operation space and joint angle limit of the safety setting.

To use the jog function, tap the  **Jog** button on the main menu.

- In Auto mode, the "**Jog**" button is disabled, so the function is unavailable.
- The Jog function cannot be used during **Servo Off**.
- The robot is operated manually in the **Jog** screen, so the robot only moves when the Jog button is pressed.
- It is possible to move the robot based on the current position on the **Jog** tab screen.
- The robot can be moved by configuring the target angle/coordinates on the **Move** tab screen.
- It is possible to configure the reference coordinates on the **Jog** tab screen and **Move** tab screen as a joint or task.
- The robot's alignment reference is selected in the **Settings** tab screen.

Note



- On the **Settings** screen, if the safety signal I/O, POS_3_ENABLE_SWITCH, is set, the Servo On and Jog functions are available only if this signal is inputted.
- If the robot cannot be navigated due to being located in a space other than the operation space of the **Jog** mode, set the robot operation space to "None" to allow the robot to be navigated.

11.1 Jog Screen

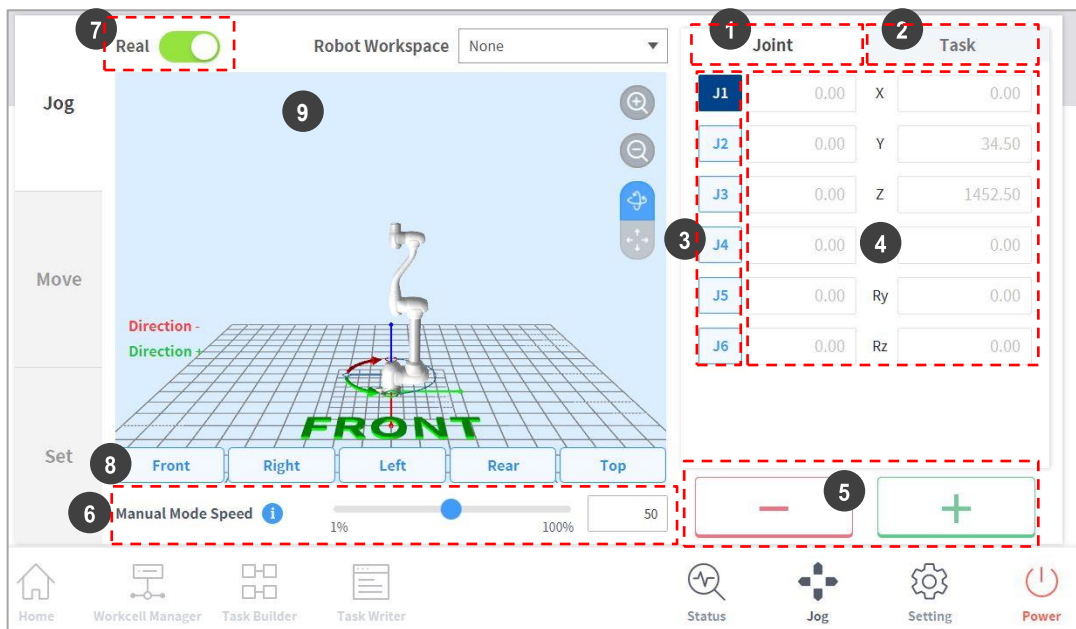
It is possible to navigate based on the current robot position on the jog screen.



No.	Item	Description
1	Joint	It configures the joint as the reference coordinate for jog mode.
2	Task	It configures the task as the reference coordinate for jog mode.
3	Select Axis	Select an axis to move in jog mode. <ul style="list-style-type: none"> • Joint Tab: Select one axis among J1 - J6. • Task Tab: Select one axis among X ~ Rz.
4	Coordinate Display	The coordinates of the robot currently operated in Jog mode is displayed. If the robot position changes by pressing the direction button, the coordinate also changes.
5	Direction	It moves the robot in the + or - direction on the selected axis.
6	Manual Mode Speed	Configures the robot movement speed in manual mode. The speed can be adjusted by dragging the slider pointer. If the slider pointer is at 100%, the corresponding maximum joint speed on the Jog tab is 30 deg/s, and the maximum task speed is 250 mm/s. This speed influences the speed controlled by the jog and movement buttons.

No.	Item	Description
7	Real Mode	It configures whether to operate the robot in real mode while in jog mode. <ul style="list-style-type: none"> • On (): The robot actually moves. • Off (): The simulator operates.
8	Simulator Alignment	It selects the alignment direction of the robot displayed in the simulator. Pressing each direction button aligns the robot in the corresponding direction.
9	Robot Workspace	It displays robot workspace information registered in the Workcell Manager in the Jog Simulator. Press the drop-down menu to select the workspace to display.

 **Note**

- TCP Speed Limit: The highest operation speed during jog and movement button operation is limited to 250 mm/s according to safety policies.
- If the robot stops due to reaching the joint limit or if a collision is detected while moving the robot with jog mode, set the safety recovery mode and move the robot to be positioned within the joint angle limit. For more information about Safety Recovery Mode, refer to “**10.7 Safety Recovery Mode.**”

11.1.1 Execute based on Joint

To adjust the angle based on the robot joint, follow these steps:

- 1 Select the **Joint** tab on the **Joint** screen.
- 2 Select the axis (J1-J6) to adjust the angle.

Joint		Task	
J1	0.00	X	0.00
J2	0.00	Y	34.50
J3	0.00	Z	1452.50
J4	0.00	Rx	0.00
J5	0.00	Ry	0.00
J6	0.00	Rz	0.00

- 3 Press and hold the Direction Button (**+** , **-**) to adjust the angle of the corresponding axis.

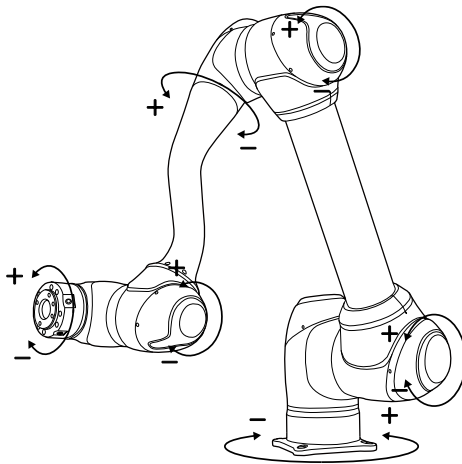

Note

Safety area does not apply in virtual mode.

11.1.2 Execute based on Robot Base

To move the robot based on the robot base, follow these steps:

- 1 Select the **Task** tab on the **Jog** screen.
- 2 Select the display coordinates to be used as the base and select the **Base** as the reference point of the task coordinates.

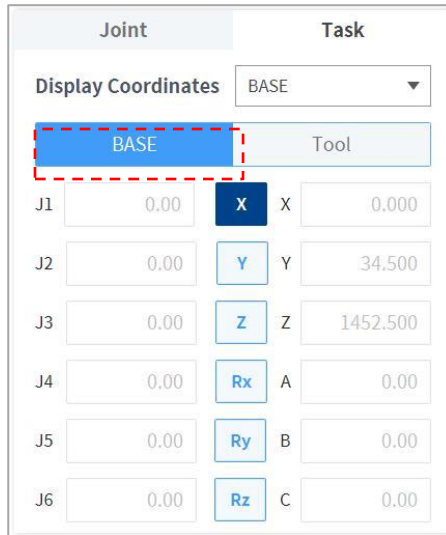

- 3 Select the Base Coordinates to move.
- 4 Press and hold the Direction Button (**+** , **-**) to move the corresponding axis.

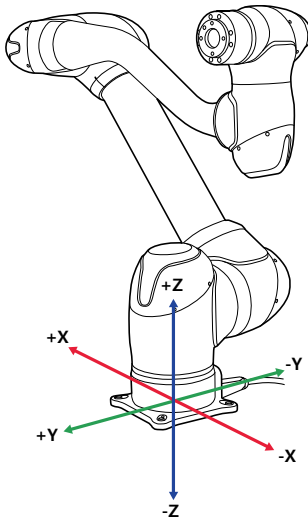

Note

- Safety area does not apply in virtual mode.

11.1.3 Execute based on World Coordinates

To move the robot based on World Coordinates, follow these steps:

- 1 Select the **Task** tab on the **Jog** screen.
- 2 Select the display coordinates to be used as World Coordinates and select **World** as the reference point of the task coordinates.

The screenshot shows a control interface for a robot's Jog screen. At the top, there is a dropdown menu labeled "Display Coordinates" with "World" selected. Below this, there are two tabs: "World" (highlighted with a red dashed border) and "Tool". The main area contains six rows of controls for joints J1 through J6. Each row has a numerical input field on the left, a central axis selection button, and a numerical output field on the right. The "X" button for J1 is highlighted in dark blue, while the other buttons are light blue.

Joint	Input	Axis	Output
J1	0.00	X	0.000
J2	0.00	Y	34.500
J3	0.00	Z	1452.500
J4	0.00	Rx	0.00
J5	0.00	Ry	0.00
J6	0.00	Rz	0.00

- 3 Select World Coordinates to move.
- 4 Press and hold the Direction Button (**+** , **-**) to move the corresponding axis.

11.1.4 Execute based on Robot Tool

To move the robot based on the robot tool, follow these steps:

- 1 Select the **Task** tab on the **Jog** screen.
- 2 Select Base or World as the display coordinates and set the **Tool** based on the reference point of the task coordinates.

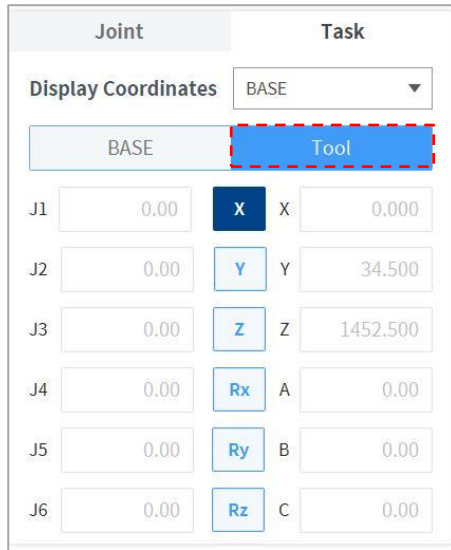

- 3 Select the Tool Coordinates to move.
- 4 Press and hold the Direction Button (+ , -) to move the corresponding axis.

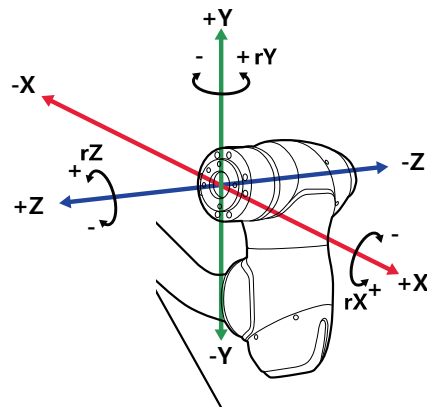

Note

- Safety area does not apply in virtual mode.
- Rx, Ry and Rz are executed according to TCP (tool center position).

11.2 Movement Screen

The robot can be moved by target angle/coordinates on the Move screen. If the coordinates the robot must move to are known or if the robot must be moved up to coordinates in decimal points, it is possible to move the robot by entering coordinates.

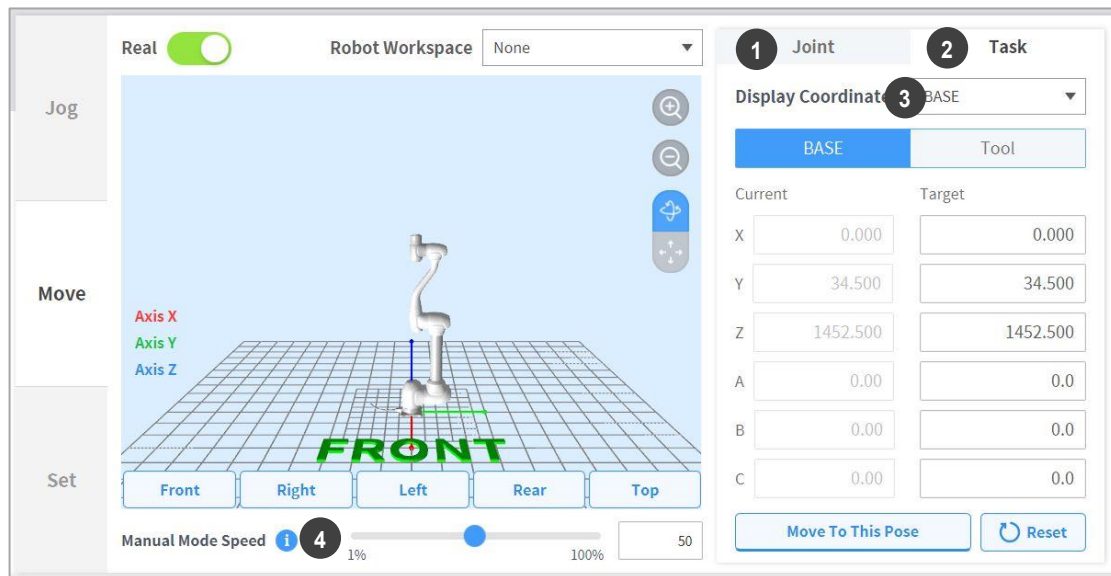

No.	Item	Description
1	Joint	It configures the reference coordinate to use when moving the robot with a jog.
2	Task	It configures the reference angle to use when moving the robot with a jog.
3	Reference Point Setting	It configures the reference point to align the task coordinate. <ul style="list-style-type: none"> • Base: It configures the task coordinate based on the robot base. • World: Sets task coordinates based on the set World Coordinates. • Tool: It configures the task coordinate based on the tool installed on the end of the robot's six-axis.
4	Manual Mode Speed	It configures the robot's movement speed in manual mode. The speed can be adjusted by dragging the slider pointer. If the slider pointer is at 100%, the corresponding maximum joint speed on the Move tab is 30 deg/s, and the maximum task speed is 250 mm/s. The speed influences the jog and button operation speed.

11.2.1 Moving with Angle Setting

To move the robot at a specific angle, follow these steps:

- 1 Select the **Move** tab and select the **Joint** tab.
- 2 Enter the target angle of the robot joint.

	Joint	Task
	Current	Target
J1	<input type="text" value="-7.57"/>	<input type="text" value="0.0"/>
J2	<input type="text" value="0.00"/>	<input type="text" value="0.0"/>
J3	<input type="text" value="0.00"/>	<input type="text" value="0.0"/>
J4	<input type="text" value="0.00"/>	<input type="text" value="0.0"/>
J5	<input type="text" value="0.00"/>	<input type="text" value="0.0"/>
J6	<input type="text" value="0.00"/>	<input type="text" value="0.0"/>

- 3 Enable the **Real Mode**.

Real Robot Workspace

- 4 Tap and hold the **Move to Corresponding Pose** button to adjust the robot joint angle.

11.2.2 Move with Base Reference Coordinates

To move the robot based on base coordinates, follow these steps:

- 1 Select the **Move** tab and select the **Task** tab.

The screenshot shows a control panel for setting robot coordinates. At the top, there is a dropdown menu labeled "Display Coordinates" with "BASE" selected. Below this are two tabs: "BASE" (highlighted in blue) and "Tool". The main area is divided into two columns: "Current" and "Target". Each column has input fields for X, Y, Z, A, B, and C axes. The "Current" values are X: 0.000, Y: 34.500, Z: 1452.500, A: 0.00, B: 0.00, C: 0.00. The "Target" values are X: 0.000, Y: 34.500, Z: 1452.500, A: 0.0, B: 0.0, C: 0.0. At the bottom, there are two buttons: "Move To This Pose" and "Reset".

	Current	Target
X	0.000	0.000
Y	34.500	34.500
Z	1452.500	1452.500
A	0.00	0.0
B	0.00	0.0
C	0.00	0.0

- 2 Select Base as the display coordinates and select the **Base** tab.
- 3 Configure the pose to move with reference to the base.
- 4 Tap and hold the **Move to Corresponding Pose** button to go to the set coordinate.

11.2.3 Move with World Coordinates Reference Coordinates

To move the robot based on World Coordinates, follow these steps:

- 1 Select the **Move** tab and select the **Task** tab.

The screenshot shows a control panel for setting robot coordinates. At the top, there is a dropdown menu labeled "Display Coordinates" with "World" selected. Below this are two tabs: "World" (highlighted in blue) and "Tool". The panel is divided into two columns: "Current" and "Target". Each column has input fields for X, Y, Z, A, B, and C axes. The "Current" values are X: 0.000, Y: 34.500, Z: 1452.500, A: 0.00, B: 0.00, and C: 0.00. The "Target" values are X: 0.000, Y: 34.500, Z: 1452.500, A: 0.0, B: 0.0, and C: 0.0. At the bottom, there are two buttons: "Move To This Pose" and "Reset".

	Current	Target
X	0.000	0.000
Y	34.500	34.500
Z	1452.500	1452.500
A	0.00	0.0
B	0.00	0.0
C	0.00	0.0

- 2 Select World as the display coordinates and select the **World** tab.
- 3 Configure the pose to move with reference to the World Coordinates.
- 4 Tap and hold the **"Move to Corresponding Pose"** button to go to the set coordinate.

11.2.4 Move with Tool Reference Coordinates

To move the robot based on tool coordinates, follow these steps:

- 1** Select the **Move** tab and select the **Task** tab.
- 2** Select the **Tool** tab.
- 3** Configure the pose to move with reference to the tool.
- 4** Tap and hold the **Move to Corresponding Pose** button to go to the set coordinate.

11.3 Setting Screen

The robot's alignment reference can be set on the **Setting** screen.

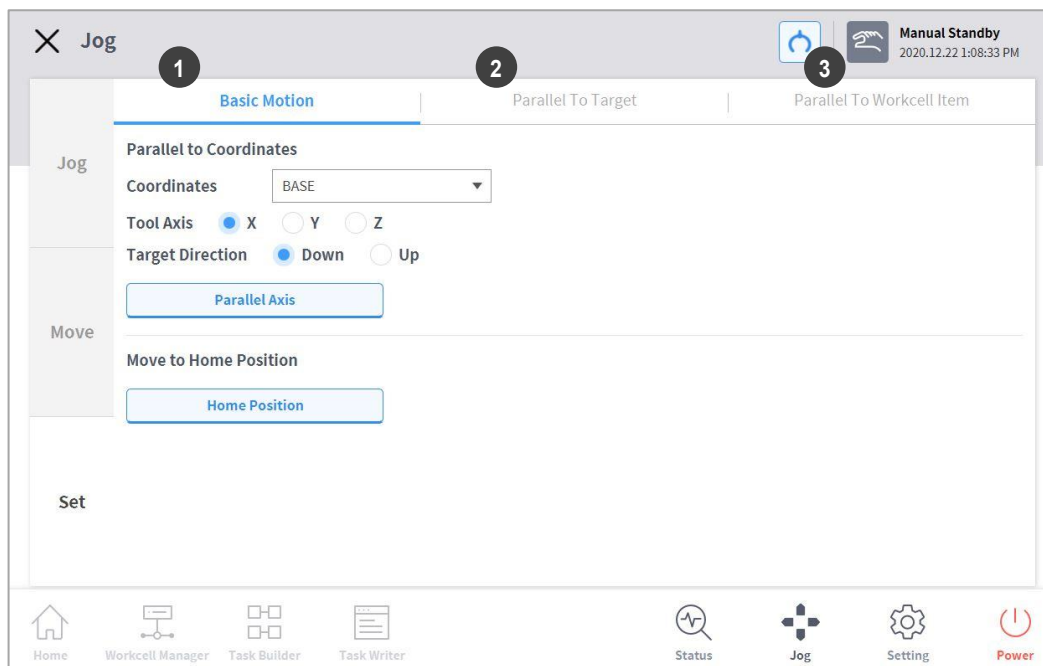

No.	Item	Description
1	Default Motion	It aligns the TCP based on the Base/World axis and target direction.
2	Align with Target	Aligns the TCP with the target.
3	Align with Workcell Item	Aligns the TCP with Workcell item.

11.3.1 Alignment based on Base Axis/World Axis

When the work item is positioned in the Base/World axis direction of the robot, it is possible to align the TCP on the workpiece before workpiece teaching. The teaching pose can be configured in line with the Base/World Coordinates axis, making it is easy to specify a teaching pose. To perform teaching after locking the pose, use the plane or line locked direct teaching function with "Cockpit" buttons.

To align the robot TCP based on the base axis, follow these steps:

- 1 Select the **Settings** tab and select the **Default Motion** tab.

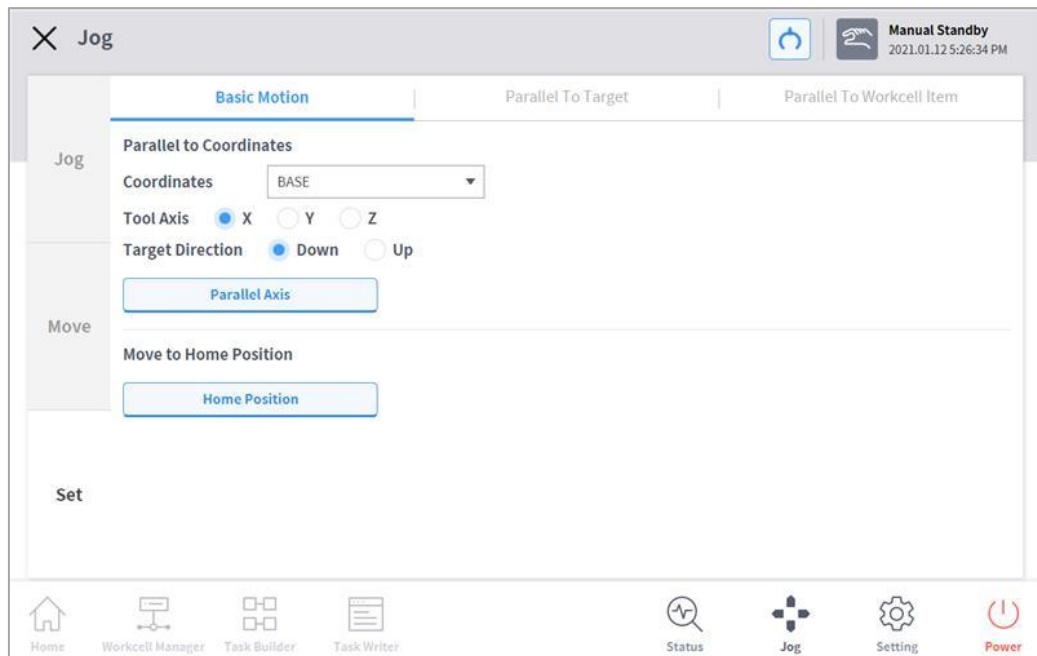

- 2 Select the reference coordinates for alignment.



- 3 Select the reference tool axis.



- 4 Select the alignment direction.

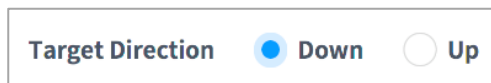

- 5 Tap and hold the **Align Axis** button to align the axis.

11.3.2 Go to Home

Moves the robot to the default home position or the user home position configured in **Settings** on the main menu.

- 1 Select the **Settings** tab and select the **Default Motion** tab.
- 2 Tap and hold the “**Home Position**” button to move the robot to the home position.

11.3.3 Alignment based on Target

This is a useful function if the workpiece is aligned with the TCP in an axis direction for workpiece teaching. To perform teaching after locking the pose, use the plane or line locked direct teaching function with cockpit buttons.

To align the robot TCP based on target, follow these steps:

- 1 Select the **Settings** tab and select **Align with Target** tab.

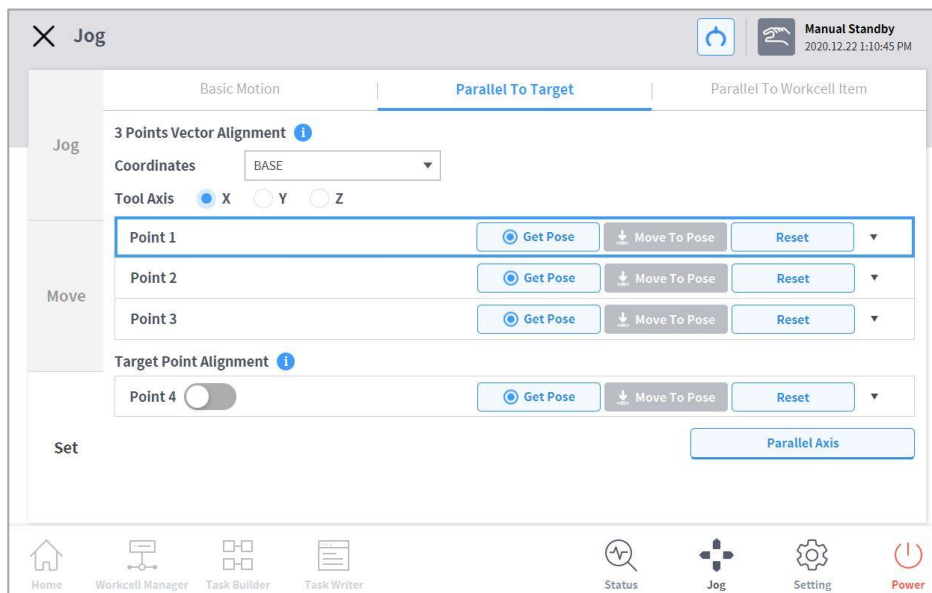

- 2 Select the reference coordinates for alignment.



- 3 Select the tool axis to align.



- 4 Move the robot to the desired position and tap **Point 1**.

- 5 Tap the **Save Pose** button of **Point 1**.

- **Point 2 and Point 3** are set in the same way. When settings are complete, a virtual vector area is set based on the three points.

Point 1	<input checked="" type="radio"/> Get Pose	↓ Move To Pose	Reset	▲
Point 2	<input checked="" type="radio"/> Get Pose	↓ Move To Pose	Reset	▲
Point 3	<input checked="" type="radio"/> Get Pose	↓ Move To Pose	Reset	▲

- 6** (Optional) To set the TCP direction and position together, press the "toggle" button of **Point 4** , move the robot to the desired position and tap the "Save Pose" button.
- 7** Tap and hold the **Align Axis** button to align the axis.
- Place the 6-axis head 150 mm above the target in the Z-axis direction.

11.3.4 Alignment based on Workcell Items

Aligns the robot TCP based on the Workcell item.

- 1 Select the **Setting** screen and select the **Alignment based on the Workcell Items** tab.
- 2 Select the desired item from the **Workcell Item**.

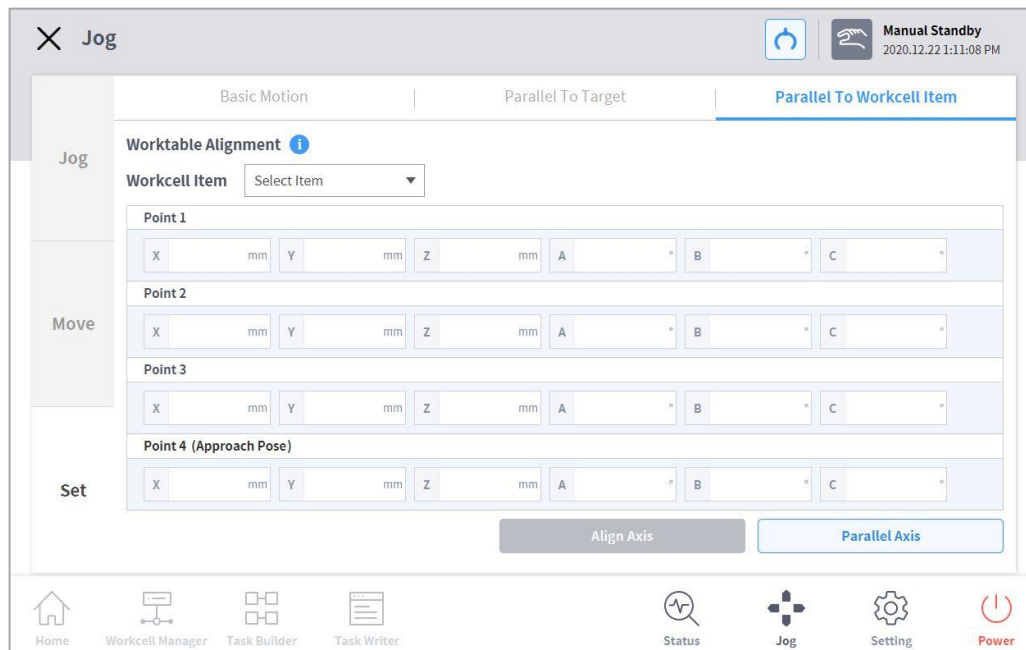

- 3 Tap and hold the **Align Axis** button to align the axis.

Note

The sorting directions for **11.3.3. Alignment based on Target** and **11.3.4. Alignment based on Workcell Items** are determined according to whether the teaching sequence of three points taught in the Workcell Item was clockwise or counter clockwise. [Refer to Figure below]

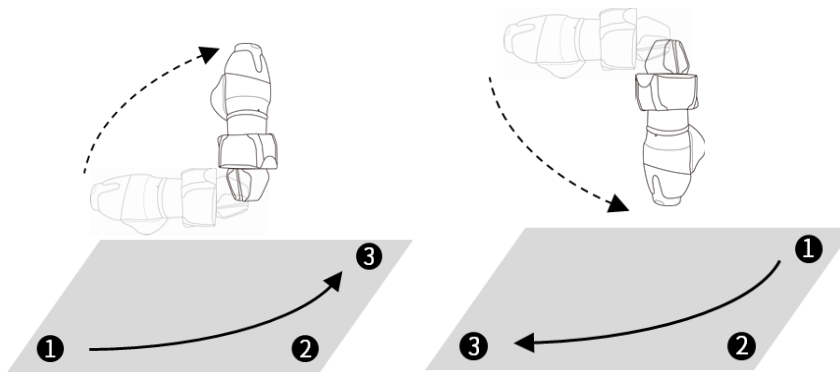

12. Environment Setting

To configure environment settings related to the operation setting, tap the **Settings** button in the main menu.

Note

- When the **Task Builder** and **Task Writer** screens are changed to the **Play** tab, the **Settings** button on the main menu is disabled.

12.1 Language Setting

To set the UI language of the operation program, follow these steps:

- 1 Tap the **Setting** button on the main menu and select **Local > Language**.
- 2 Select the language from the language list and tap the **Confirm** button.
- 3 To change the SI units to U.S. units, select “English (INCH)” and tap the Confirm button.
 - The units displayed on the program change to U.S. units.
- 4 Restart the system.

12.2 Date and Time Setting

To set the date, follow these steps:

- 1 Tap the **Settings** button on the main menu and select **Date and Time > Date**.
- 2 Set the date and tap the **Confirm** button.

To set the time, follow these steps:

- 1 Tap the **Settings** button on the main menu and select **Date and Time > Time**.
- 2 Set the time and tap the **Confirm** button.

Note

- The log time of the logs saved in the system maintain the existing date and time even after changing the date and time of the system.
- If the system is accessed via Windows, the Date and Time setting function is not available, and the system automatically synchronizes with the date and time of Windows.

12.3 Robot Setting

Configures the default pose and cockpit related functions.

12.3.1 Robot Home Position Setting

- 1 Tap the **Settings** button on the main menu and select **Robot Settings > Home Position**.
- 2 Select the **User Home Position**.
 - Selecting **Default Home Position** sets the default.
- 3 Move the robot to the desired position and tap the **Save Pose** button.
- 4 Tap the **Confirm** button.

12.3.2 Cockpit Setting

- 1 Tap the **Settings** button on the main menu and select **Robot Settings > Cockpit**.
- 2 Select individual functions for **Button 1** and **Button 2** from the drop-down list.
- 3 To activate **Exit Cockpit**, press and hold **Button 1** and **Button 2** simultaneously for 2 seconds.
- 4 When selection is completed, tap the **Confirm** button.

 **Note**

- The values of **Button 1** and **Button 2** must be different.

12.3.3 Remote Control Setting

- 1** Select the **Remote Control** menu in the **Robot Setting** menu.
 - The current setting information is displayed in the setting management window.
- 2** Set the **Use Remote Control** button to ON.
 - If the system is restarted with remote control set to ON, it boots up in remote control mode.
- 3** Enter the output signal, input signal and default load task values.
 - If the input signal is not set, settings cannot be made.
 - In the Setting – Workcell Manager – Safety Signal I/O – Input tab, configure REMOTE_CONTROL_MODE and REMOTE_EMERGENCY_STOP.
- 4** Tap the **Confirm** button when complete.
 - This completes the environment settings for remote control.
- 5** To allow remote control using an external device, tap the **Start Remote Control** button to engage remote control mode.
 - Information on tasks to execute from the external device appears.
 - Motion inputs from the external device can only be executed if a green signal is displayed on the “Enable Remote Control” button.
 - If a red signal is displayed on the Enable Remote Control button, input an enable signal from the external device.

Note

- If a safety stop occurs in remote control mode, it is handled as follows:
 - Safety Stop 1: A popup screen is displayed and closes automatically.
 - Safety Stop 2: If a Task Stop signal input is made, the Stop button is pressed, and if a Task Resume signal input is made, the Restart button is pressed. However, in Servo Off mode, the popup can be released using the Servo button.
- Used to turn ON/OFF the power of the remote control.
 - Tap the Settings button of the main menu, and select **Remote Control** under **Robot Settings**.
 - Select the Power ON or OFF setting to turn the dedicated remote control port on or off.

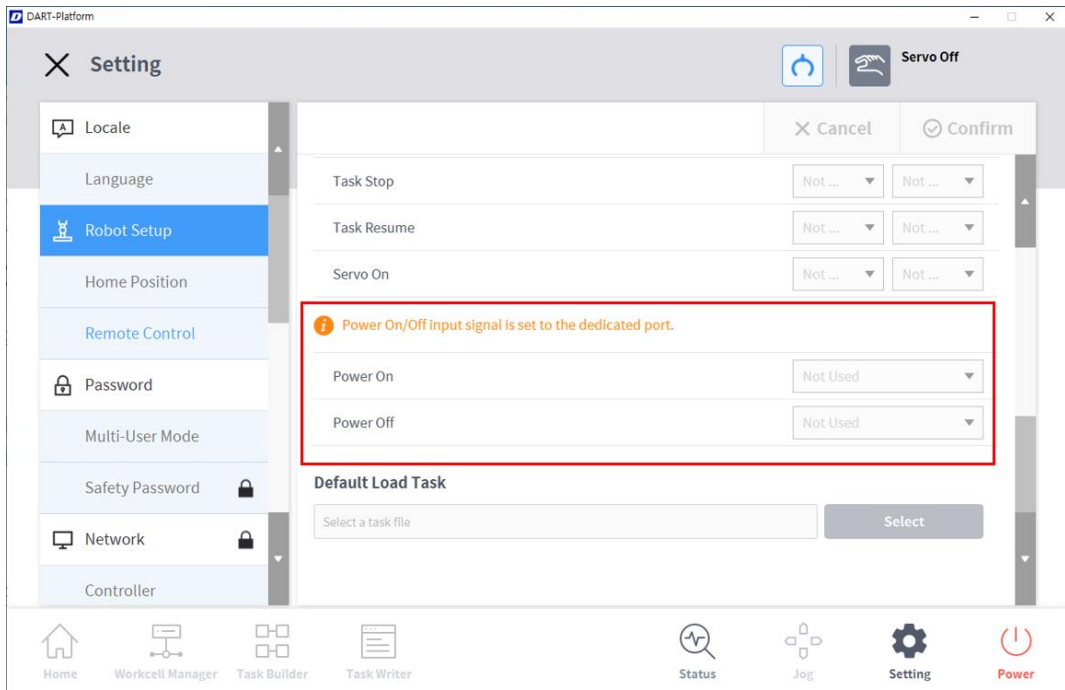

12.3.4 Smart Pendant Setting

Version A Series

- Smart Pendant setting is a screen to set the functions provided as options of A-Series.

- Select the **Smart Pendant Setting** menu in the **Robot Setting** menu.
 - The current setting information is displayed in the setting management window.
- Set the **Use Smart Pendant** toggle to ON.
 - If the system is restarted with the use Smart Pendant set to ON, it boots up in remote control mode.
- Select Task
 - It is the task to be used in Smart Pendant mode.
- Click the Confirm button and click the Start Smart Pendant button.
 - The Smart Pendant dashboard screen is displayed and commands using Smart Pendant become available.

When the Smart Pendant mode launches from Windows, the teach pendant screen also changes to the Smart Pendant screen.

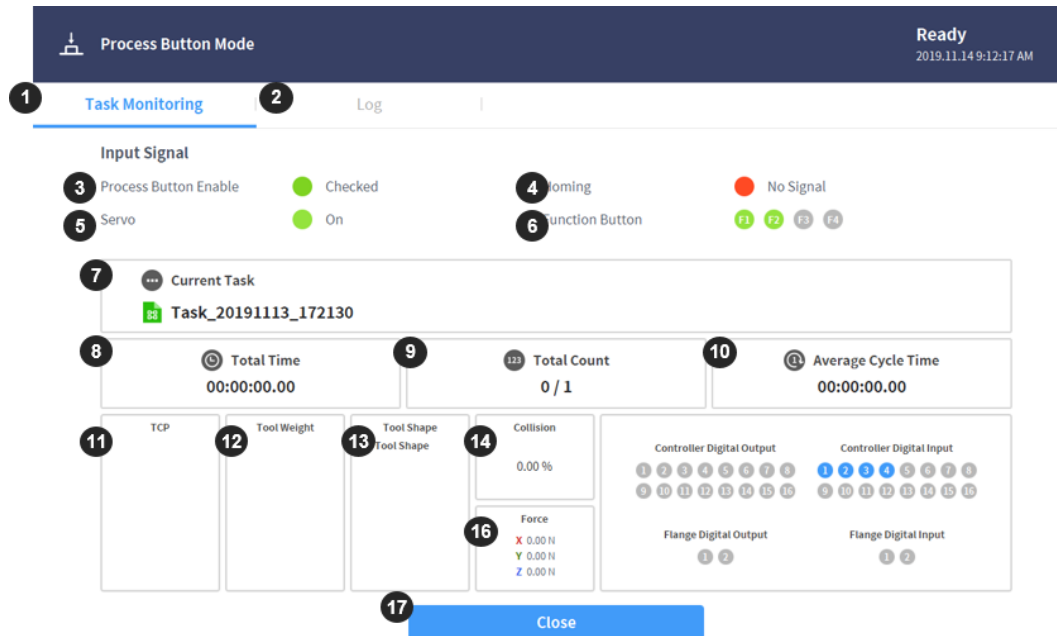

No.	Item	Description
1	Task Monitoring Tab	It is the tab that displays monitoring information necessary for executing the input signal and Task of Smart Pendant.

No.	Item	Description
2	Log Tab	It is the tab that displays the log messages collected during task execution.
3	Smart Pendant Enable Signal	When the Smart Pendant is connected to the controller, it is displayed as Checked (green).
4	Homming Signal	When the homming button of the Smart Pendant is pressed, the indicator is displayed as Checked (green).
5	Servo On/Off Signal	Displays the Servo On/Off status
6	Function Button Signal	Indicators of P1-P4 press status
7	Current Task	Area displaying the task to be used by the Smart Pendant
8	Total Time	Total Task play time
9	Total Count	Count of Task loops
10	Average Cycle Time	Average play time of each task cycle
11	TCP Indicator	TCP information used by the current task
12	Tool Weight Indicator	Tool Weight information used by the current task
13	Tool Shape Indicator	Tool Shape information used by the current task
14	Collision	Collision threshold information
15	Force	Force information
16	Digital / Flange I/O information	Digital / Flange I/O information
17	Close	Button to close the Smart Pendant mode.

Note

If a safety stop occurs in Smart Pendant Mode, it is handled as follows:

- Safety Stop 1: A popup screen is displayed and closes automatically.
- Safety Stop 2: If a Smart Pendant Stop button input is made, the Stop button is pressed, and if a Smart Pendant Resume button input is made, the Restart button is pressed. However, in Servo Off mode, the popup can be released using the Servo button.

12.4 Change and Disable Password

A password is required to enter a setting with a lock icon (🔒).

To change or disable the password of settings with a lock icon, follow these steps:

- 1 Select **Password > Safety Password** in the Settings menu.
- 2 Enter the current password of the program and tap the **Confirm** button.
 - The initial system password is admin.
 - To disable the password, tap the **Password Lock** button and disable.

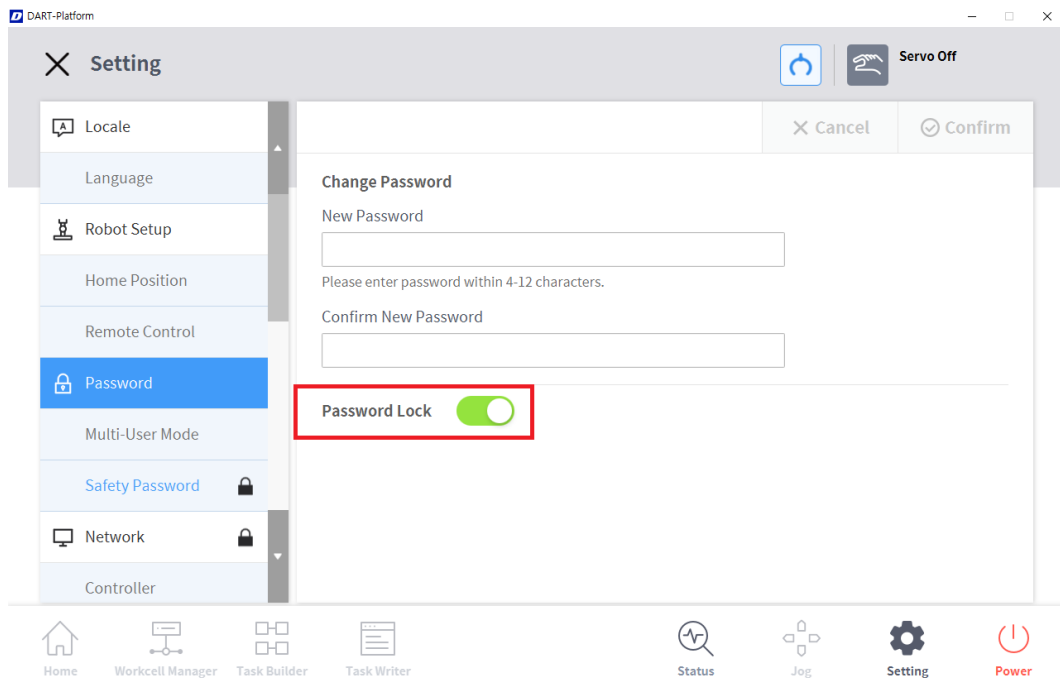

- 3 Tap the **Confirm** button.

Note

- If the user forgets the password, the system must perform factory reset.
- Even if the password lock is disabled, rebooting the system will enable password lock.

12.5 User Role Setting

Accessible menus can be limited according to user roles.

1 Select **Password > Use User Role** in the Settings menu.

- The User Role On/Off, description of user role and Change Password buttons appear in the settings management window.

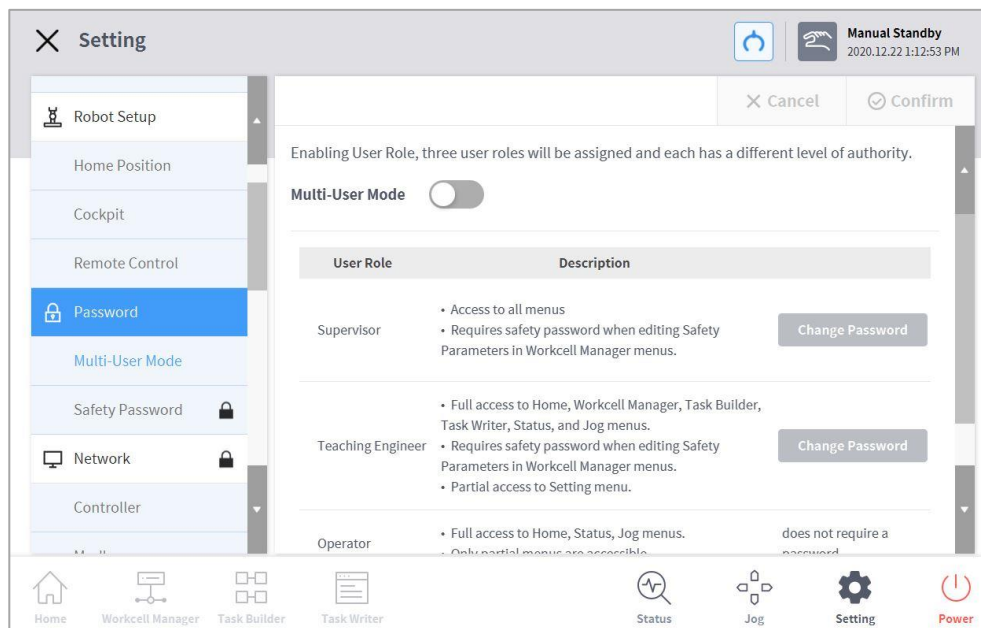

2 To enable/disable a user role, press the User Role On/Off button.

- A screen asking for the administrator password is displayed.
- When user authority is changed from Off to On, the screen returns to the Home screen and changes to operator role.

3 Enter the new password in the Change Password field and tap the **Confirm** button.

- Password change settings are complete.

4 To change a user role, tap the **User Role** button.

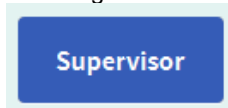

Note

- The initial administrator password is admin.
- The initial teaching engineer password is admin.
- If the **User Role** button is disabled, it operates in the same way as an administrator role.

12.6 Network Setting

To set the network, follow these steps:

- 1 Tap the **Settings** button of the main menu and select **Network**.
- 2 Select the **Controller** or **Modbus** tab.
 - **Controller:** Ethernet network settings for external connections such as the controller or Modbus can be configured.
 - **Modbus:** Additional settings for user-defined Modbus including Modbus TCP/RTU and additional settings for Preset Modbus used by some Workcell items can be set.
- 3 Select the network method and tap the **Confirm** button.

Version A Series

- To be able to set and use DHCP in A-Series models, it is necessary to purchase an external router and configure a network.

12.6.1 User-defined Modbus Support Function Code

The Modbus Master of Doosan Robotics can be used for I/O expansion or data exchanges through connections with other devices.

The Function Codes supported by Doosan Robotics are as follows:

Function Code	Description
1	Read Coils
2	Read Discrete Inputs
3	Read Multiple Holding Registers
4	Read Input Registers
5	Write Single Coil
6	Write Single Holding Register
15	Multiple Coils (FC15)
16	Multiple Holding Registers (FC16)

*DRL (set_modbus_outputs()) is configured to internally call FC5 and FC6 multiple times.

Note

- Up to five Modbus Slave devices can be connected.
- Each device can register up to 50 registers.
- The total number of registers cannot exceed 100.

12.6.2 Register User-defined Modbus

Modbus communication with random devices can be performed using a user-defined Modbus.

- 1** Select the **Modbus** menu from **Settings > Network** and select the **Add TCP Slave** or **Add RTU Slave** button.
- 2** The Modbus slave will be added to the Modbus Slave List.
- 3** To set the Modbus slave and to add/delete signals, select the **View** button.
- 4** In the case of a TCP Slave, enter the IP address of the slave device and set the Port (default: 502).
- 5** In the case of a RTU Slave, select the **Serial Port** to perform communication, and set **Communication Speed, Parity Bit, Data Bit** and **Stop Bit**. If the serial port has been added using a USB port, select the **Search** button to search the new device and select the Serial Port.
- 6** If a signal must be added, press the **Add Signal** button.
- 7** If a signal must be deleted, press the **Delete Signal (-)** button.
- 8** Set the **Signal Type, Signal Address, Signal Name** and **Slave ID** for the newly added signal.
 - In the case of a TCP Slave, the default Slave ID is 255. However, if Advanced Settings is checked, the Slave ID can be modified (1-247).
 - In the case of **Signal Type** Multiple Coils for FC 15 and Multiple Holding Registers for FC 16, select the **Edit** button to add multiple signals by entering the **Signal Name, Start Address** and **Count**. An individual signal name is assigned automatically by **Signal Name**.
- 9** Select the **Settings** button.
- 10** Modbus registration begins after selecting the **Settings** button, and a message is displayed if the process fails. In such case, check the connection with the Modbus device and the Modbus Slave settings.
- 11** If the Modbus has been successfully registered, the input and output of the registered signal can be checked.
 - An output motion can be performed by entering a value and selecting the → button.

12.6.3 Register Preset Modbus

Modbus communication with a specific Workcell item provided by Doosan Robotics can be performed using Preset Modbus. In such case, register a Preset Modbus and set the signal in Workcell Manager.

- 1** Select the **Modbus** menu from **Settings > Network** and select the **Add TCP Slave** or **Add RTU Slave** button.
- 2** A Modbus Slave is added to the Modbus Slave List and performs Modbus registration, and a message is displayed if the process fails.
- 3** To check the status of the signal registered to the Modbus Slave, select the **View** button. If the registration process fails, check the connection with the device and select the **Settings** button.
- 4** If the Modbus has been successfully registered, the input and output of the registered signal can be checked from the Details screen.
 - An output motion can be performed by entering a value and selecting the → button.

Note

- The Modbus RTU function is provided through DRL.
- DRL used for ModbusRTU Master only added `add_modbus_rtu_signal()`.
- Other DRLs are used in the same way, except for `add_modbus_signal()`, which is used to add signals.
- DRL (`serial_get_count()`, `serial_get_info()`) are added to check serial port information.
- For more detailed description about DRL, refer to the Programming Manual.

12.7 System Update

The current robot system version can be checked, and the system can be updated using an external storage device.

12.7.1 Unified Update

This provides new unified updates. The unified update file updates the entire system including the user software, robot inverter and safe mode.

- 1 Connect the external storage device with the update file to the controller.
- 2 Tap the **Settings** of the main menu, and select **Robot Update > Update**.
- 3 Tap the **Update** button on the teach pendant and controller.
- 4 When the update window appears, tap the **Search** button.
- 5 Select the update file from the searched list.
- 6 Tap the **Check File** button.
 - If the file check is successful, **Version to Install** below will display version information, and the **Next** button will be enabled.
 - If the file check fails, examine the file for any issues.
- 7 Tap the **Next** button.
- 8 Read the Cautions and Terms and Conditions for Agreement, and tap the checkbox below to enable the **Agree and Proceed** button.
- 9 Tap the **Agree and Proceed** button.
- 10 Tap the **Start Update** button.
 - Once the update starts, the progress and update log can be viewed from this screen.
- 11 When the update is complete, restart the system. The controller must be restarted to ensure proper operation.
- 12 If the update fails, tap the **Restart Update** button to reinstall or the **Restore Previous Version** button to restore the version before the update.
- 13 Restarting the system without a successful update will activate App Recovery Mode. Reinstall the update using Unified Update in App Recovery Mode to complete the update. The update must be successfully installed to ensure proper operation.



Caution

- Do not remove the external storage device or turn off the system during the update. This may damage the robot or cause malfunctions.

- If both Update Restart and Restore Previous Version fail, reboot and enter Recovery Mode to restore the system. For more information, refer to **3.7 Application Recovery Mode Screen**.

 **Note**

- If the system is accessed via Windows, only controller software update is performed. Updates for the program from Windows must be performed separately.
- In addition, if the update is performed on Windows, the update cannot be performed in Servo On mode due to safety reasons. Perform the update with in Servo Off mode.

12.7.2 System Restore

Restores the robot system to a specific version the user chooses.

- 1 Select **Robot Update > System Restore** in the Setting menu.
 - The last five versions installed on the robot system are displayed.
 - The current version is displayed with the Radio button selected.
- 2 Select the Radio button of the version to be restored.
 - The Restore button is enabled.
- 3 Press the Restore button.
- 4 Restart the system when restore is complete.

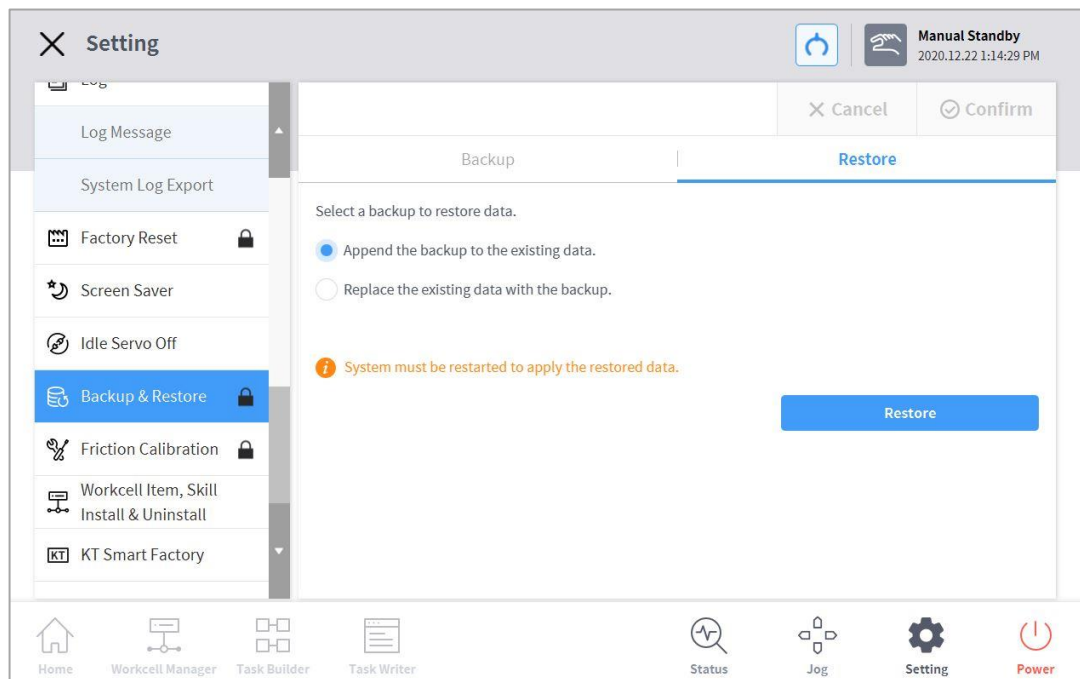

Note

- If the system is accessed via Windows, the system restore function is not available.

12.8 Check and Enter Robot License Code

The serial number and model number of the robot system can be checked, and the product license can be entered or checked. The serial number, model number and license are used for customer support services.

To enter a new license code, follow these steps:

- 1 Tap the **Settings** button on the main menu and select **License**.
- 2 If the license requires an update, enter the newly issued license code and restart the system.

12.9 Check Log

To check the log message of the robot, tap the **Settings** button and select **Log**.

12.9.1 System Log

System log messages of the robot can be checked. Search can be made in units of 1 month, and logs can be deleted.

12.9.2 Extract Log

Logs created during robot operation can be saved on a USB storage media. Search can be made in units of 1 week.

12.10 Factory Reset

Factory reset is a function used to delete all user data and logs saved on the robot. When factory reset is performed, the database, log files, Workcell Items and task files are deleted.

- 1 Tap the **Setting** button on the main and select **Factory Reset**.
- 2 Tap the **Reset** button.
- 3 When reset is complete, restart the system.

12.10.1 Delete Log

Delete log is a function that deletes all logs saved on the robot.

How to delete Logs

- 1 Tap the **Setting** button on the main menu and select **Factory Reset**.
- 2 Tap the **Delte** button.
- 3 Deletion status can be checked in **System Log Items**.

12.10.2 License Type and Factory Reset Range according to Vision Connection

Vision License Status	Vision Connection Status	Details	Remarks
O	O	Factory reset including Vision data	Vision Category of WCM screen retained
O	X	A Vision Connection-related popup* is displayed, and no factory reset	
X	O	Factory reset excluding Vision data	
X	X	Factory reset excluding Vision data	

Popup Message

- English: Please connect the vision camera and proceed with factory reset.

12.11 Screen Saver Mode Setting

If the teach pendant is not used for a set amount of time, the system enters screen saver mode.

- The robot can enter screen saver mode even if it is operating in Auto mode.
- Tap the **Return** button on the screen saver to return to the previous screen.

To configure the screen saver mode, follow these steps:

- 1** Tap the **Settings** button on the main menu and select **Screen Saver**.
- 2** Screen saver use can be configured in the Screen Saver Setting screen.
 - The default setting is **Use Screen Saver**.



- 3** This configures the time required to elapse before entering the screen saver mode.
 - Default: 5 minutes
 - Minimum Time: 1 minute
 - Maximum Time: 24 hours (1440 minutes)
- 4** Tap the **Confirm** button.

12.12 Idle Servo Off

If the robot is idle for a certain amount of time, the robot is automatically set to the Safety Off state. The default value is 5 minutes, and the time can be changed to a time the user prefers

12.13 Friction Calibration

Version A Series

- This function automatically calibrates the friction created from the robot axis in A-Series. Friction calibration is performed during initial manufacturing, and it can be performed again when maintenance is needed. Friction calibration must be done after the robot is sufficiently warmed up to ensure optimized direct teaching and collision detection performance. Performing 3-4 minutes of all-axis movement from a cold start is recommended for robot warm-up. If the robot movement is too fast, if the supporting force is excessive during direct teaching, or if frequent collision detection occurs at default collision detection sensitivity, it is recommended that friction calibration be performed again.

- 1 Tap the **Settings** button on the main menu and select **Friction Calibration**.
- 2 Select the **axis to calibrate** friction.
- 3 Enter the friction calibration start position according to the angle limit range of **start position** of each axis.
- 4 Enter the **range** to measure from the friction calibration start position according to the angle limit range.
 - It is recommended to include the **robot operation range** as much as possible.
- 5 Tap the **Auto Calculate** button.
- 6 Tap the **Motion Check** button of the auto measure motion check popup window.
 - Auto measure motion check is performed in sequential order of axes selected after the entire axis moves to the start position.
 - Auto measure motion check **stops** when the stop button is tapped.
- 7 After auto measure motion check, tap the **Auto Calculate** button of the auto calculate popup window.
 - Auto calculate is performed in sequential order of axes selected after the entire axis moves to the start position.
 - Auto calculate stops when the stop button is tapped.
- 8 When the Auto Calculate of selected axes is complete, the **friction calibration result** is displayed on each axis.
 - Successful results are displayed in green and failed results are displayed in gray.
- 9 Tap the **Confirm** button.

Note

Instances of reapplying friction calibration are as follows:

- If more than one joint module is replaced
- If direct teaching does not operate properly even when the tool weight and weight center point settings are correct

12.14 KT Smart Factory Setting Screen

This screen sets the KT Smart Factory function.

- 1** Tap the **Settings** button and select **KT Smart Factory**.
- 2** Enter values according to the validation of each item.
- 3** Items required are IP address, port value, Device ID, Device Password, Gateway ID and transmission frequency.
- 4** Pressing the **Confirm** button applies the entered values.

12.15 Backup & Restore

Some of the data used by the teach pendant can be backed up and restored. The file extension for add-on backups is .append, and the file extension for overwrite backups is .replace. Restore is only available for the same software version and the same robot model. When a backup file including a Workcell item is restored, all Workcell items that can be disabled are disabled. If the item to be restored is restored to a robot without the corresponding license, restoration is performed normally, but any items with licenses are not displayed.

In the case of an add-on restore, if the backup file contains a Workcell item, Task and Modbus created at the same time, each of them is overwritten with the item, Task and Modbus to be restored. If an identical system parameter name is present, the restore process cannot proceed. If the maximum allowed number of additions for working space, tool weight, tool shape, watermark, user coordinates, end effector and system parameter items are exceeded, the restore process is stopped.

Item	Maximum Number of Additions
Workspace	10 for each item
Tool Weight	50
Tool Shape	50
User Coordinates	20
End Effector	50
System Parameters	50

If a task with an identical name is present on the Teach Pendant to be restored during task add-on restore, the serial number of the robot used to backup the task is added to the name of the restored task. If an item from one of the categories below is included in the overwrite restore, the items in each of the existing categories are deleted and the backed up data is restored.

Category	Range
Workspace	All working spaces (space limits, collaborative zones, collision avoidance zones, collision sensitivity reduction zones, tool orientation limit zones, user defined zones)
Tool Weight	All tool weights
Tool Shape	All tool shapes
Robot Installation Pose	All robot installation poses
User Coordinates	All user coordinates

End Effector	All end effectors
Machine	All machines
Peripherals	All peripherals (Smart Vision Module and welding condition are excluded)
System Parameters	All system parameters
Task Builder	All Task Builder tasks
Task Writer	All Task Writer tasks
Modbus	All Modbus Slaves

Workcell items from other companies downloaded through Doosan Mate can only be restored to robot models that the corresponding item was created.

Items that support all and individual data add-ons are as follows:

- Items registered in Workcell Manager (excluding items with default settings in which additional registrations cannot be performed)
- System Parameters
- Task Builder Task file
- Task Writer Task file
- Setting (Modbus)

Items that support all and individual data overwriting are as follows:

- Items registered in Workcell Manager
- System Parameters
- Task Builder Task file
- Task Writer Task file
- Settings (cockpit, remote control, smart pendant (A Series), Modbus, screen saver, idle servo off)

To backup data, follow these steps:

- 1** Tap the **Settings** button and select Backup & Restore.
- 2** Choose whether to backup data for the purpose of add-on or overwriting.
- 3** (For backing up all data) Select the Backup All Data checkbox and press the Backup button.

- 4 (For backing up individual data) Select checkboxes for data items for backup and press the Backup button.
- 5 Select the directory to save.

To restore data, follow these steps:

- 1 Tap the **Settings** button and select Backup & Restore.
- 2 Press the Restore menu.
- 3 Choose whether to restore data with add-on or with overwriting.
- 4 Press the Restore button.
- 5 Select the file to be restored from the Select File pop-ups.
- 6 When restore is complete, restart the system.

12.16 Workcell & Skill Installation and Removal

The list of external skills and workcells installed on the Teach Pendant can be viewed.

Information provided in the list includes name, manufacturer, version and status.

Installed skills and workcells can be deleted.

When deleting an installed skill or workcell, detailed information of the item to be deleted is displayed.

New items can be installed and executed.

Multiple items can be selected to be installed.

Rebooting after installation is required to ensure proper execution.

If a skill or workcell used by a task are deleted, the corresponding task cannot be opened.

13. Smart Pendant (A Series)

13.1 Functions of Smart Pendant

Item	Function Description
Power on/off	<ul style="list-style-type: none"> - With the Smart Pendant turned off, press and hold the button to turn on the system. - When the Smart Pendant is powered on and the button is pressed once, the Robot, Device and Function LEDs blink white. And when the button is pressed again, the power is turned off. When the Robot, Device, and Function LEDs blink white, the Smart pendant returns to normal again if no additional button input is available for more than 5 seconds. - Press and hold the button to force shutdown while the Smart Pendant is powered on.
Robot LED	<p>Robot LED is used to indicate the robot status by displaying the same color as the robot status LED in Smart Pendant. The details are “13.2 Smart Pendant Robot LED Color”.</p>
Device LED	<p>This LED tells you whether or not to enter the Smart Pendant Mode.</p> <ul style="list-style-type: none"> - Smart Pendant Mode not entered : Red - Smart Pendant Mode entered : White
Function LED	<p>When the four Function Buttons (F1 through F4) are pressed, the LED turns on to indicate the pressed state.</p>
Function(F1~F4)	<p>The button that applies the digital signal allows the user to use the input of the button for the desired role on the DRL.</p>
Home	<ul style="list-style-type: none"> - The button for performing homing and mastering that operates only in manual mode. - You have to keep the button pressed to perform the function. In this case LED will turn on. When homing and mastering are completed or the button is released, LED will turn off. - If the robot requires homing and mastering based on its own judgment, the LED on the home button flashes to inform you that action is required.
Servo	<p>The button that enables Servo to be on/off turns the LED on when Servo on, and the LED turns off when Servo off.</p>
Auto	<p>This button switches between auto mode and manual mode, the LED turns on in auto mode and the LED turns off in manual mode.</p>
Play	<p>The button to start a program set to the robot can only be operated in auto mode. During a program running, the LED always turns on and turns off if the program is stopped or shut down. If you start a program with the Play button, it always runs from the beginning of the program.</p>

Item	Function Description
Stop	This is a button that shuts down a running program. The LED turns on whenever the program is not running.
Pause	The button that pauses a running program. While the program is paused, the LED is always on. While it is paused, pressing the Play button while it is stopped will start the program from the beginning and pressing the Resume button will start the program from the moment it stops.
Resume	This button re-runs the program from the moment it stops.

13.2 Smart Pendant Robot LED Color

The Smart Pendant Flange LED uses the same color as the robot status LED. Refer to “**3.4.4 Status and Flange LED Color for Each Mode**” for the LED colors of each robot status.

Annex A. Upper/Lower Threshold Range and Default Value of Safety Parameters

A.1 M1509

Parameters		Normal			Reduced			Tolerance (+/-)
		Min	Max	Default	Min	Max	Default	
Joint Angle Limits	J1 (degree)	-360	360	-360~360	-360	360	-360~360	3/-3
	J2 (degree)	-360	360	-95~95	-360	360	-95~95	3/-3
	J3 (degree)	-150	150	-135~135	-150	150	-135~135	3/-3
	J4 (degree)	-360	360	-360~360	-360	360	-360~360	3/-3
	J5 (degree)	-360	360	-135~135	-360	360	-135~135	3/-3
	J6 (degree)	-360	360	-360~360	-360	360	-360~360	3/-3
Joint Speed Limits	J1 (degree/s)	0	150	150	0	150	150	10
	J2 (degree/s)	0	150	150	0	150	150	10
	J3 (degree/s)	0	180	180	0	180	180	10
	J4 (degree/s)	0	225	225	0	225	225	10
	J5 (degree/s)	0	225	225	0	225	225	10
	J6 (degree/s)	0	225	225	0	225	225	10
Robot/TCP Limits	Force (N)	0	800	162	0	800	81	-
	Power (W)	0	1600	650	0	1600	120	-
	Speed (mm/s)	0	7000	2000	0	7000	1000	-
	Momentum (kgm/s)	0	135	68	0	135	40	-
	Collision Detection Sensitivity (%)	1	100	75	-	-	-	-
Safety I/O	Speed Reduction Ratio (%)	-	-	-	0	100	20	-

A.2 M1013

Parameters		Normal			Reduced			Tolerance (+/-)
		Min	Max	Default	Min	Max	Default	
Joint Angle Limits	J1 (degree)	-360	360	-360~360	-360	360	-360~360	3/-3
	J2 (degree)	-360	360	-95~95	-360	360	-95~95	3/-3
	J3 (degree)	-160	160	-135~135	-160	160	-135~135	3/-3
	J4 (degree)	-360	360	-360~360	-360	360	-360~360	3/-3
	J5 (degree)	-360	360	-135~135	-360	360	-135~135	3/-3
	J6 (degree)	-360	360	-360~360	-360	360	-360~360	3/-3
Joint Speed Limits	J1 (degree/s)	0	120	120	0	120	120	10
	J2 (degree/s)	0	120	120	0	120	120	10
	J3 (degree/s)	0	180	180	0	180	180	10
	J4 (degree/s)	0	225	225	0	225	225	10
	J5 (degree/s)	0	225	225	0	225	225	10
	J6 (degree/s)	0	225	225	0	225	225	10
Robot/TCP Limits	Force (N)	0	550	144	0	550	72	-
	Power (W)	0	1600	600	0	1600	100	-
	Speed (mm/s)	0	8000	2000	0	8000	1500	-
	Momentum (kgm/s)	0	165	82	0	165	50	-
	Collision Detection Sensitivity (%)	1	100	75	-	-	-	-
Safety I/O	Speed Reduction Ratio (%)	-	-	-	0	100	20	-

A.3 M0617

Parameters		Normal			Reduced			Tolerance (+/-)
		Min	Max	Default	Min	Max	Default	
Joint Angle Limits	J1 (degree)	-360	360	-360~360	-360	360	-360~360	3/-3
	J2 (degree)	-360	360	-95~95	-360	360	-95~95	3/-3
	J3 (degree)	-165	165	-145~145	-165	165	-145~145	3/-3
	J4 (degree)	-360	360	-360~360	-360	360	-360~360	3/-3
	J5 (degree)	-360	360	-135~135	-360	360	-135~135	3/-3
	J6 (degree)	-360	360	-360~360	-360	360	-360~360	3/-3
Joint Speed Limits	J1 (degree/s)	0	100	100	0	100	100	10
	J2 (degree/s)	0	100	100	0	100	100	10
	J3 (degree/s)	0	150	150	0	150	150	10
	J4 (degree/s)	0	225	225	0	225	225	10
	J5 (degree/s)	0	225	225	0	225	225	10
	J6 (degree/s)	0	225	225	0	225	225	10
Robot/TCP Limits	Force (N)	0	500	108	0	500	54	-
	Power (W)	0	1600	600	0	1600	100	-
	Speed (mm/s)	0	8000	2000	0	8000	1500	-
	Momentum (kgm/s)	0	180	90	0	180	55	-
	Collision Detection Sensitivity (%)	1	100	75	-	-	-	-
Safety I/O	Speed Reduction Ratio (%)	-	-	-	0	100	20	-

A.4 M0609

Parameters		Normal			Reduced			Tolerance (+/-)
		Min	Max	Default	Min	Max	Default	
Joint Angle Limits	J1 (degree)	-360	360	-360~360	-360	360	-360~360	3/-3
	J2 (degree)	-360	360	-95~95	-360	360	-95~95	3/-3
	J3 (degree)	-150	150	-135~135	-150	150	-135~135	3/-3
	J4 (degree)	-360	360	-360~360	-360	360	-360~360	3/-3
	J5 (degree)	-360	360	-135~135	-360	360	-135~135	3/-3
	J6 (degree)	-360	360	-360~360	-360	360	-360~360	3/-3
Joint Speed Limits	J1 (degree/s)	0	150	150	0	150	150	10
	J2 (degree/s)	0	150	150	0	150	150	10
	J3 (degree/s)	0	180	180	0	180	180	10
	J4 (degree/s)	0	225	225	0	225	225	10
	J5 (degree/s)	0	225	225	0	225	225	10
	J6 (degree/s)	0	225	225	0	225	225	10
Robot/TCP Limits	Force (N)	0	400	96	0	400	48	-
	Power (W)	0	1600	300	0	1600	80	-
	Speed (mm/s)	0	7000	2000	0	7000	1000	-
	Momentum (kgm/s)	0	75	38	0	75	23	-
	Collision Detection Sensitivity (%)	1	100	75	-	-	-	-
Safety I/O	Speed Reduction Ratio (%)	-	-	-	0	100	20	-

A.5 A0509, A0509S

Parameters		Normal			Reduced			Tolerance (+/-)
		Min	Max	Default	Min	Max	Default	
Joint Angle Limits	J1 (degree)	-360	360	-360~360	-360	360	-360~360	3/-3
	J2 (degree)	-360	360	-95~95	-360	360	-95~95	3/-3
	J3 (degree)	-160	160	-135~135	-160	160	-135~135	3/-3
	J4 (degree)	-360	360	-360~360	-360	360	-360~360	3/-3
	J5 (degree)	-360	360	-135~135	-360	360	-135~135	3/-3
	J6 (degree)	-360	360	-360~360	-360	360	-360~360	3/-3
Joint Speed Limits	J1 (degree/s)	0	180	180	0	180	180	10
	J2 (degree/s)	0	180	180	0	180	180	10
	J3 (degree/s)	0	180	180	0	180	180	10
	J4 (degree/s)	0	360	360	0	360	360	10
	J5 (degree/s)	0	360	360	0	360	360	10
	J6 (degree/s)	0	360	360	0	360	360	10
Robot/TCP Limits	Force (N)	0	450	200	0	450	100	-
	Power (W)	0	2000	600	0	2000	100	-
	Speed (mm/s)	0	7000	2000	0	7000	1000	-
	Momentum (kgm/s)	0	75	38	0	75	23	-
	Collision Detection Sensitivity (%)	1	100	75	-	-	-	-
Safety I/O	Speed Reduction Ratio (%)	-	-	-	0	100	20	-

A.6 A0912, A0912S

Parameters		Normal			Reduced			Tolerance (+/-)
		Min	Max	Default	Min	Max	Default	
Joint Angle Limits	J1 (degree)	-360	360	-360~360	-360	360	-360~360	3/-3
	J2 (degree)	-360	360	-95~95	-360	360	-95~95	3/-3
	J3 (degree)	-160	160	-135~135	-160	160	-135~135	3/-3
	J4 (degree)	-360	360	-360~360	-360	360	-360~360	3/-3
	J5 (degree)	-360	360	-135~135	-360	360	-135~135	3/-3
	J6 (degree)	-360	360	-360~360	-360	360	-360~360	3/-3
Joint Speed Limits	J1 (degree/s)	0	180	180	0	180	180	10
	J2 (degree/s)	0	180	180	0	180	180	10
	J3 (degree/s)	0	180	180	0	180	180	10
	J4 (degree/s)	0	360	360	0	360	360	10
	J5 (degree/s)	0	360	360	0	360	360	10
	J6 (degree/s)	0	360	360	0	360	360	10
Robot/TCP Limits	Force (N)	0	600	300	0	600	150	-
	Power (W)	0	2000	1100	0	2000	180	-
	Speed (mm/s)	0	8000	2000	0	8000	1500	-
	Momentum (kgm/s)	0	165	82	0	165	50	-
	Collision Detection Sensitivity (%)	1	100	75	-	-	-	-
Safety I/O	Speed Reduction Ratio (%)	-	-	-	0	100	20	-

A.7 H2515

Parameters		Normal			Reduced			Tolerance (+/-)
		Min	Max	Default	Min	Max	Default	
Joint Angle Limits	J1 (degree)	-360	360	-360~360	-360	360	-360~360	3/-3
	J2 (degree)	-125	125	-95~95	-125	125	-95~95	3/-3
	J3 (degree)	-160	160	-145~145	-160	160	-145~145	3/-3
	J4 (degree)	-360	360	-360~360	-360	360	-360~360	3/-3
	J5 (degree)	-360	360	-135~135	-360	360	-135~135	3/-3
	J6 (degree)	-360	360	-360~360	-360	360	-360~360	3/-3
Joint Speed Limits	J1 (degree/s)	0	100	100	0	100	100	10
	J2 (degree/s)	0	80	80	0	80	80	10
	J3 (degree/s)	0	100	100	0	100	100	10
	J4 (degree/s)	0	180	180	0	180	180	10
	J5 (degree/s)	0	180	180	0	180	180	10
	J6 (degree/s)	0	180	180	0	180	180	10
Robot/TCP Limits	Force (N)	0	1200	243	0	1200	122	-
	Power (W)	0	1600	800	0	1600	650	-
	Speed (mm/s)	0	2500	2000	0	2500	1500	-
	Momentum (kgm/s)	0	400	200	0	400	122	-
	Collision Detection Sensitivity (%)	1	100	75	-	-	-	-
Safety I/O	Speed Reduction Ratio (%)	-	-	-	0	100	20	-

A.8 H2017

Parameters		Normal			Reduced			Tolerance (+/-)
		Min	Max	Default	Min	Max	Default	
Joint Angle Limits	J1 (degree)	-360	360	-360~360	-360	360	-360~360	3/-3
	J2 (degree)	-125	125	-95~95	-125	125	-95~95	3/-3
	J3 (degree)	-160	160	-145~145	-160	160	-145~145	3/-3
	J4 (degree)	-360	360	-360~360	-360	360	-360~360	3/-3
	J5 (degree)	-360	360	-135~135	-360	360	-135~135	3/-3
	J6 (degree)	-360	360	-360~360	-360	360	-360~360	3/-3
Joint Speed Limits	J1 (degree/s)	0	80	80	0	80	80	10
	J2 (degree/s)	0	80	80	0	80	80	10
	J3 (degree/s)	0	80	80	0	80	80	10
	J4 (degree/s)	0	180	180	0	180	180	10
	J5 (degree/s)	0	180	180	0	180	180	10
	J6 (degree/s)	0	180	180	0	180	180	10
Robot/TCP Limits	Force (N)	0	1200	243	0	1200	122	-
	Power (W)	0	1600	800	0	1600	650	-
	Speed (mm/s)	0	2500	2000	0	2500	1500	-
	Momentum (kgm/s)	0	400	200	0	400	122	-
	Collision Detection Sensitivity (%)	1	100	75	-	-	-	-
Safety I/O	Speed Reduction Ratio (%)	-	-	-	0	100	20	-



Doosan Robotics

www.doosanrobotics.com